

Luna Quick install 2.0

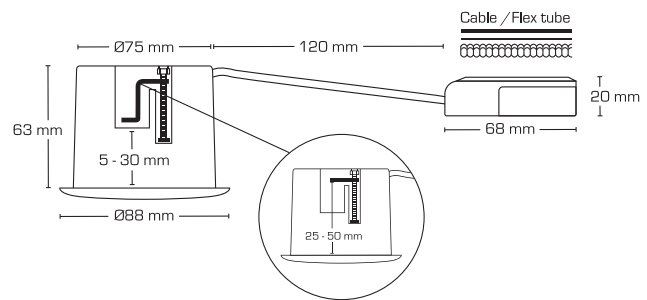

Monteringsvejledning / Monteringsanvisning / Montasjeanvisning / Installation instructions / Installationsanleitung / Asennusohje

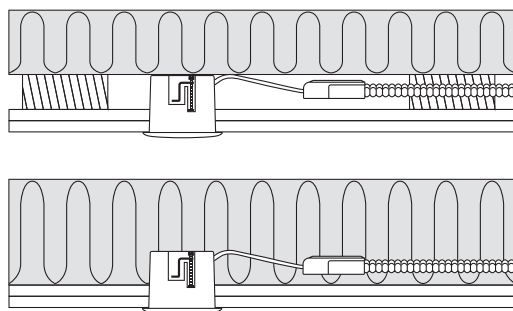
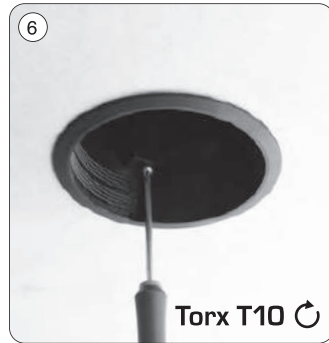
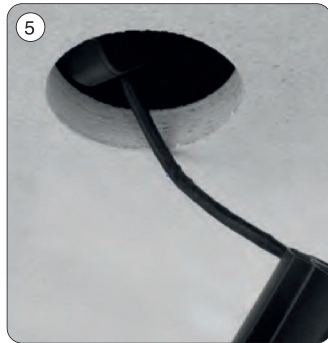
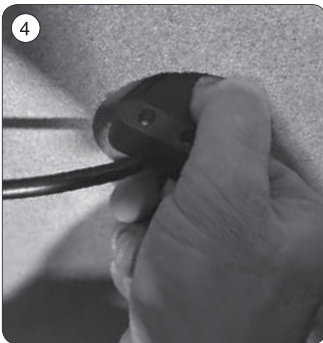
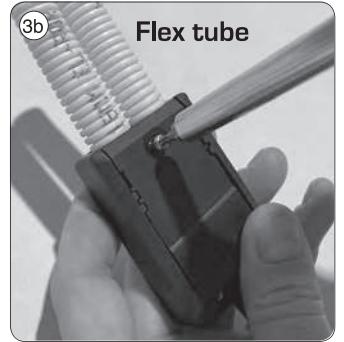
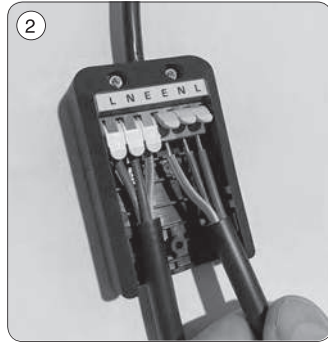

220-240 VAC	IP44	0.5m	Ø75	H 63 mm	28°	Dimmable						CE
-------------	------	------	-----	---------	-----	----------	--	--	--	--	--	----

We refer to our website www.scan-products.com regarding: products, documentation, approvals, dimmer overview, etc.