

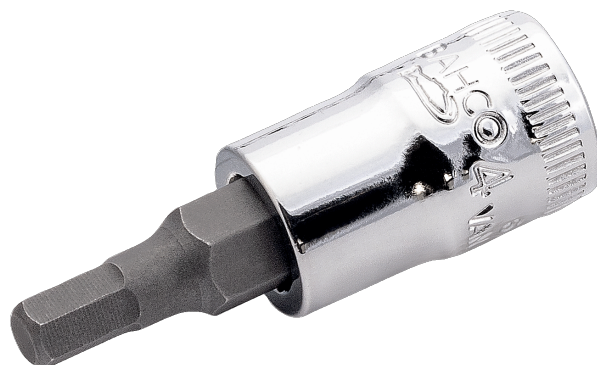

6709M-8

**1/4" skruetrækkertop med
indvendig firkant til 8 mm
sekskantskrue**



PRODUKTOPLYSNINGER

- Rulleteret til fingerfastgørelse af fritløbende fastgørelseselementer
- Ikke velegnet til maskinel brug eller elværktøj
- Højglanspoleret
- Højtlegeret stål
- Standarder: ISO 1174 og DIN 3120

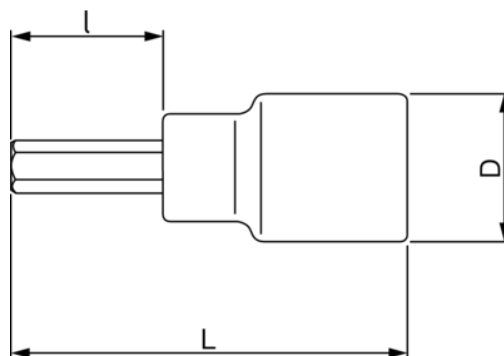

PRODUKTATTRIBUTTER

Produkt		I	L	D	
6709M-8	8 mm	16 mm	36 mm	12 mm	13 g

Follow the Fish!

