

# Connect Bridge Kit

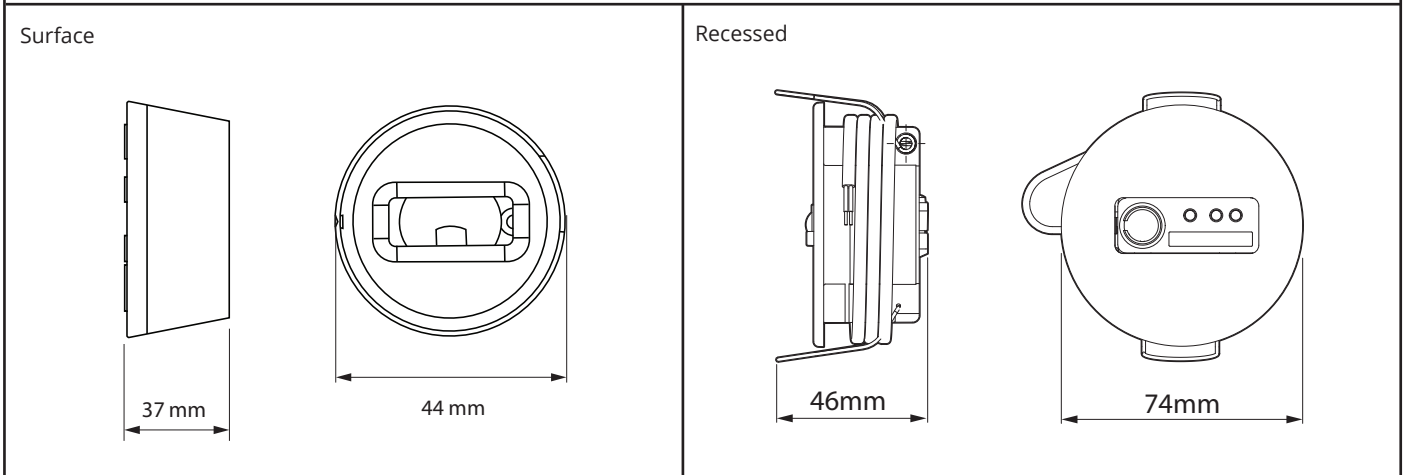

220-240V~ 50/60Hz

<p><b>Connect</b> SG Connect Commissioning</p>	<p><b>Connect</b> SG Connect User</p>	<p>Range: 10m in open air</p>		
--	---	-------------------------------	--	--

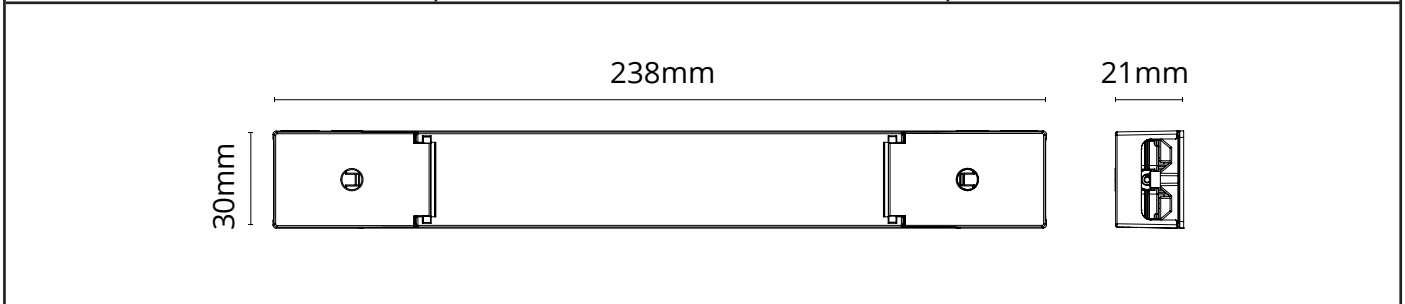

**NO:** Kan kun installeres og vedlikeholdes av en registrert installasjonsvirksomhet.  
**DK:** Må kun installeres og vedlikeholdes af uddannet elektriker.  
**SE:** Skall installeras och underhållas av behörig elektriker.  
**EN:** Only to be installed and maintained by an authorized electrician.  
**FR:** Doit être installé et maintenu par un électricien qualifié.  
**NL:** Mag alleen geïnstalleerd en onderhouden worden door een bevoegde electricien.  
**DE:** Dieses Produkt darf nur durch autorisiertes Personal (z.B. Elektro-Installateur) angeschlossen, in Betrieb genommen und gewartet werden.  
**FI:** Asentaa ja huoltaa saa vain valtuutettu sähköasentaja

**NO:** Skru av strømmen før montering.  
**DK:** Sluk for strømmen inden montering.  
**SE:** Stäng av strömmen innan montering.  
**EN:** Turn off power before installing.  
**FR:** Couper le courant avant l'installation.  
**NL:** Stroom uitschakelen voor u het toestel installeert.  
**DE:** Vor Installationsarbeiten den Strom abschalten.  
**FI:** Sammuta virta ennen kytkemistä

**NORWAY**  
SG Armaturen AS

Skytterheia 25  
N-4790 Lillesand

Tel: +47 37 50 03 00  
firmapost@sg-as.no  
www.sg-as.no

**SWEDEN**  
SG Armaturen AB  
Tel: +46 31 81 71 10  
info@sg-ab.se  
www.sg-ab.se

**FINLAND**  
SG Armaturen Oy  
Tel: +358 02 07 30 39 60  
info@sg-oy.fi  
www.sg-oy.fi

**DENMARK**  
SG Armaturen A/S  
Tel: +45 70 70 72 13  
info@sg-as.dk  
www.sg-as.dk

**UNITED KINGDOM**  
SG Lighting LTD  
Tel: +47 37 50 03 00  
info@sglighting.co.uk  
www.sglighting.co.uk

**FRANCE**  
SG Lighting SA/NV  
Tel: +33(0) 4 94 93 00 00  
info.france@sglighting.net  
www.sglighting.net

**BENELUX**  
SG Lighting SA/NV  
Tel: +32(0) 15 20 72 71  
info.benelux@sglighting.net  
www.sglighting.net

**GERMANY**  
SG Leuchten GmbH  
Tel: +49 40 23 99 44 59  
info@sg-leuchten.de  
www.sg-leuchten.de

**INTERNATIONAL**  
SG Lighting Co Ltd.  
Tel: +86 769 88 49 20 88  
cindy@sgdgc.com  
www.sg-as.com

ON/OFF + DALI BROADCAST, MAX 400VA, 20 DALI ECG

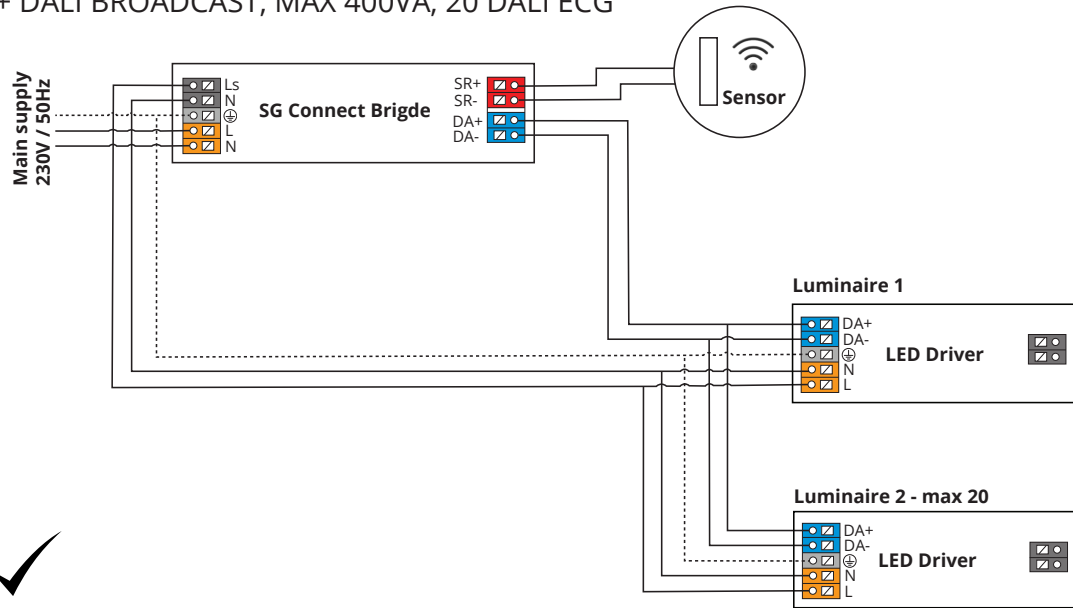

DALI BROADCAST, MAX 20 DALI ECG

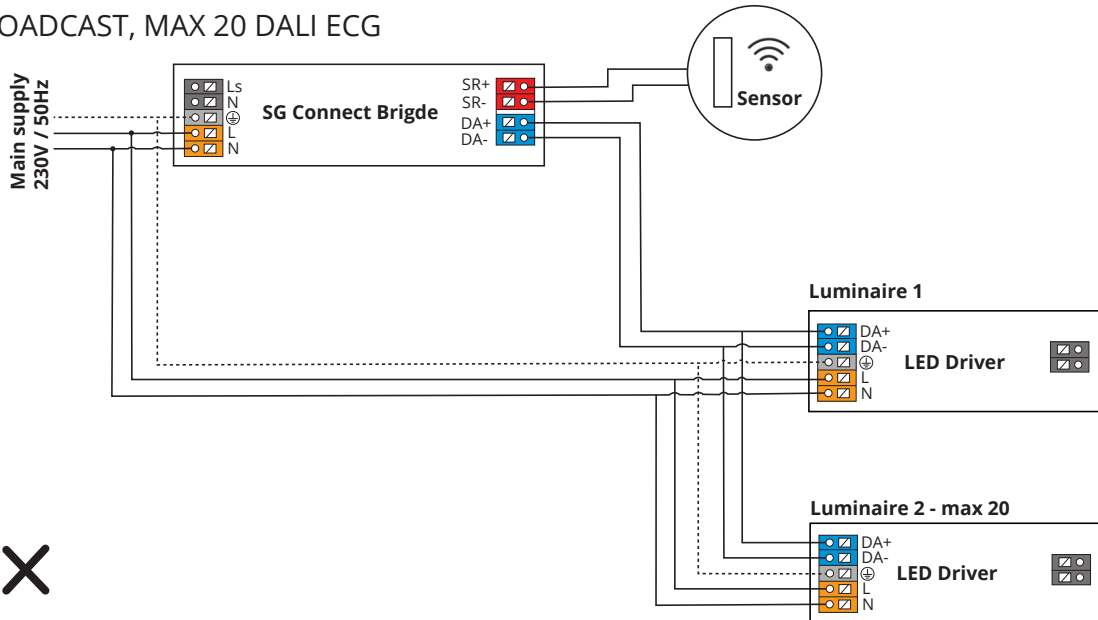

ON/OFF, MAX 400VA

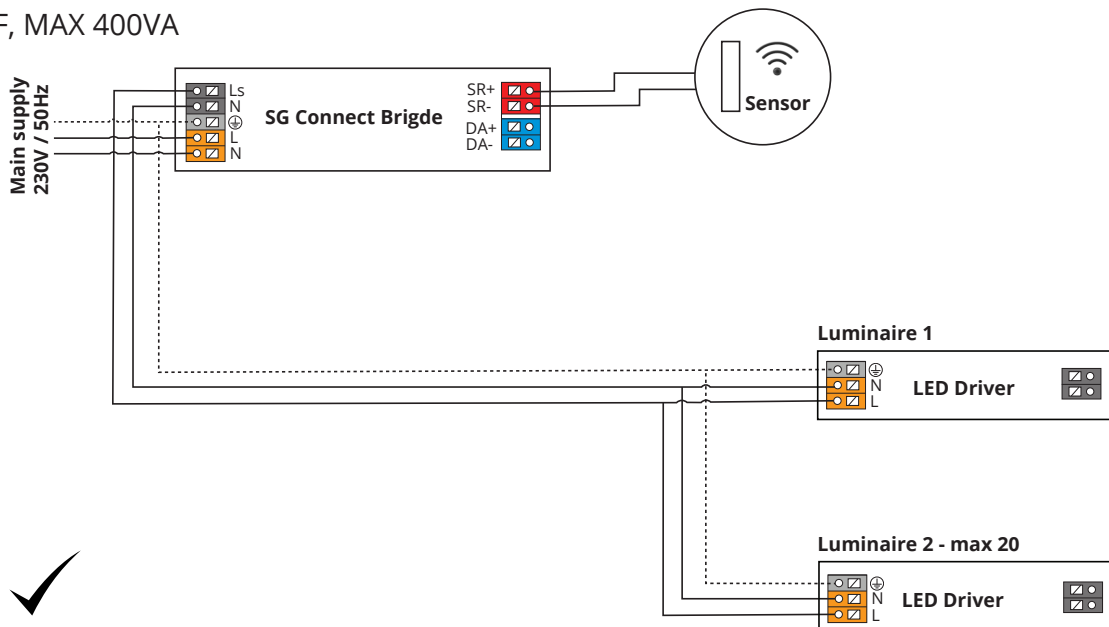

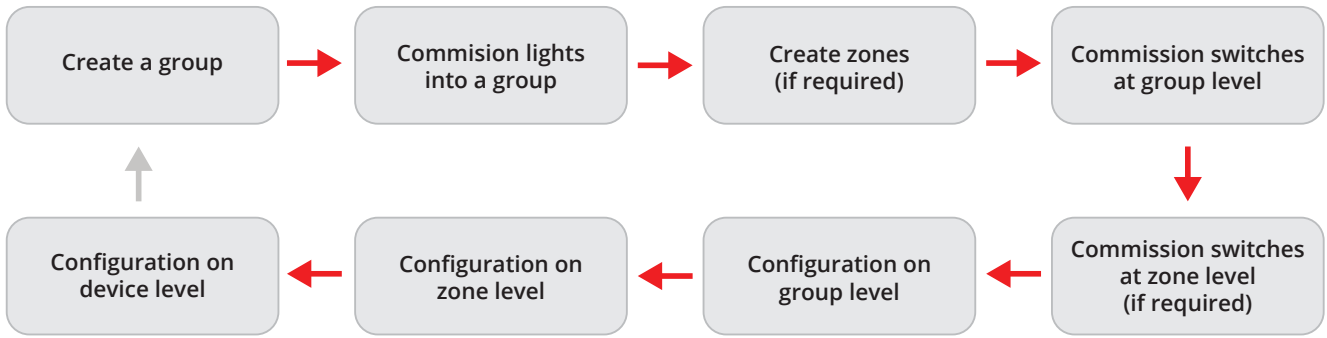

## 1 Login

1.1

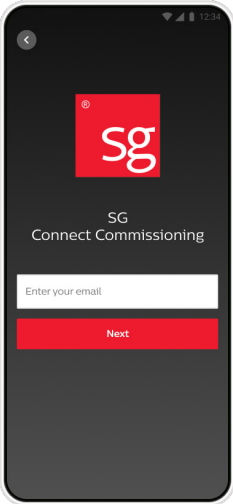

1.2

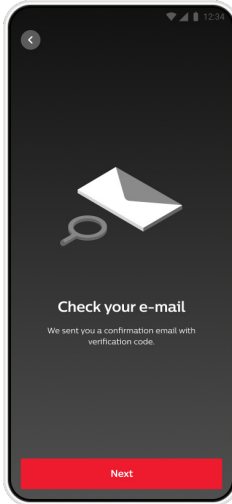

1.3

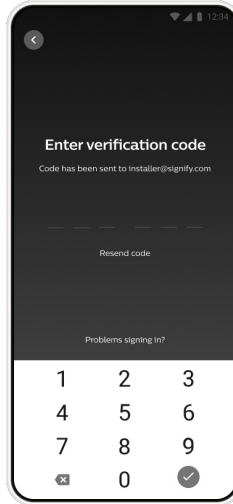

1.4

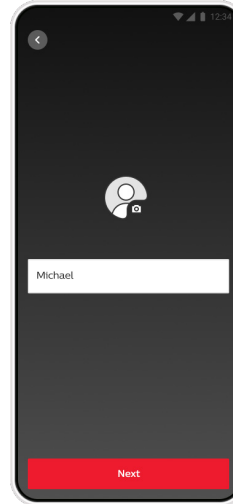

## 2 Create Group

2.1

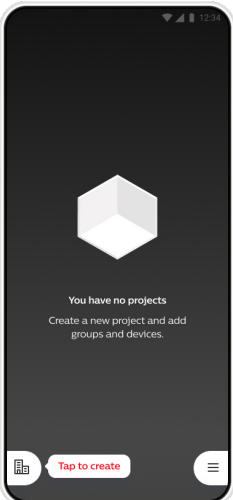

2.2

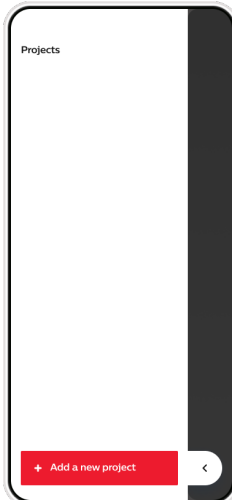

2.3

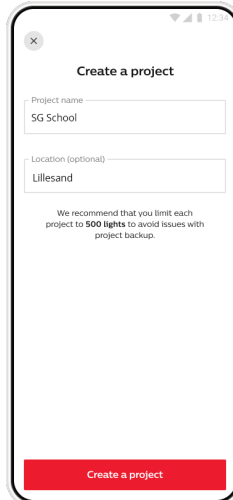

2.4

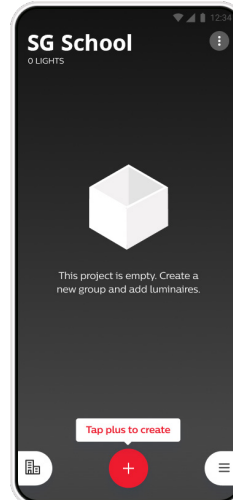

2.5

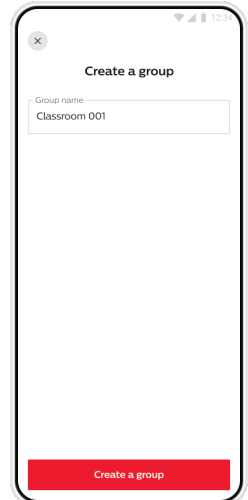

2.6

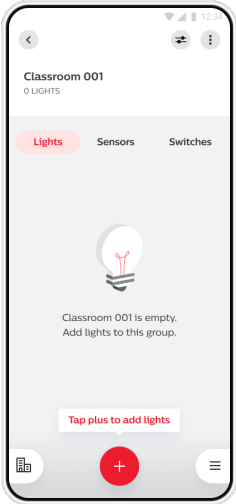

2.7



### 3 Torchlight Commissioning

3.1

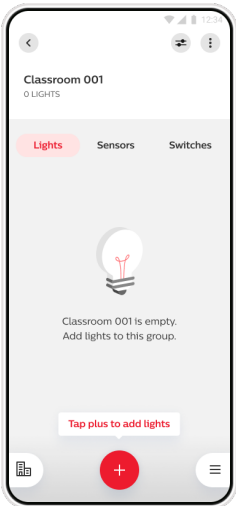

3.2

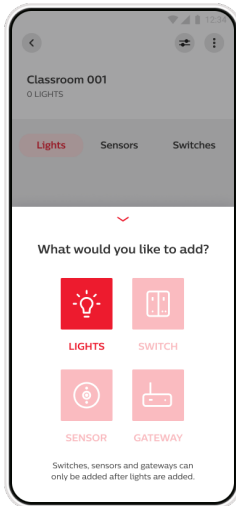

3.3

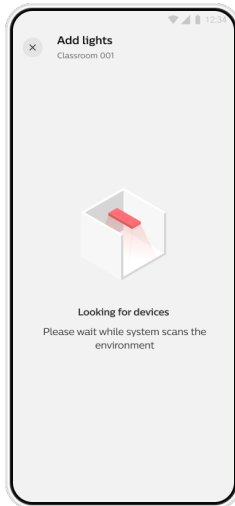

3.4

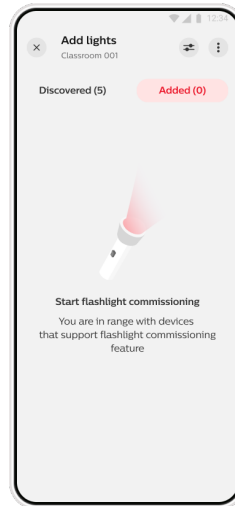

3.5

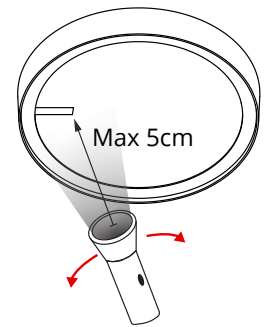

3.6

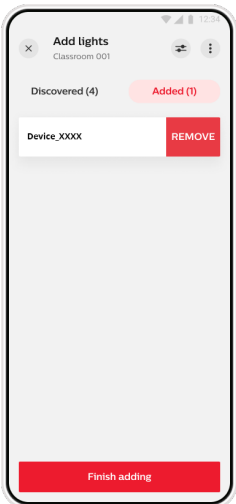

3.7

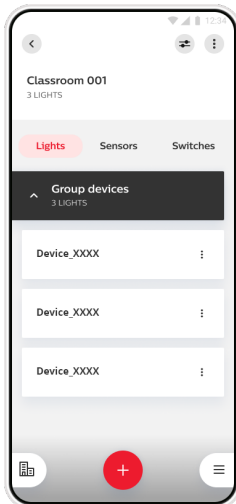

## 4 List Based Commissioning

4.1

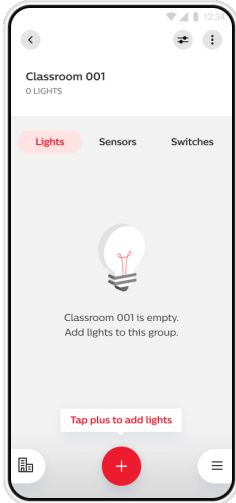

4.2

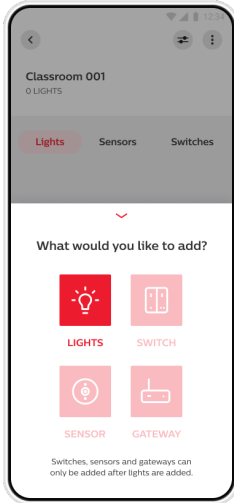

4.3

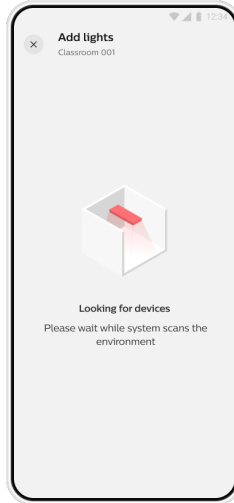

4.4

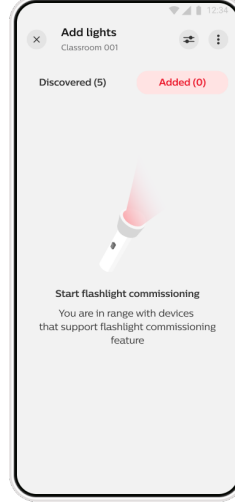

4.5

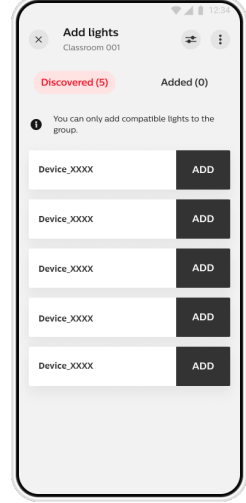

4.6

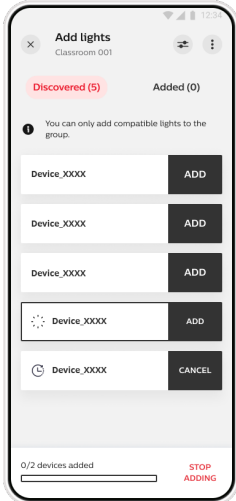

4.7

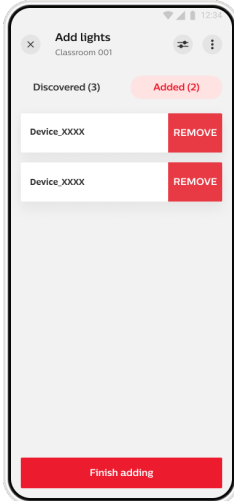

4.8

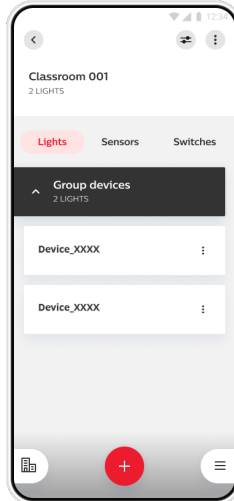

## 5 Create Zone

5.1

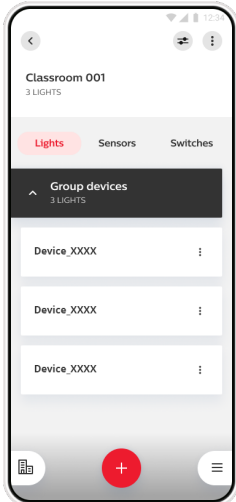

5.2

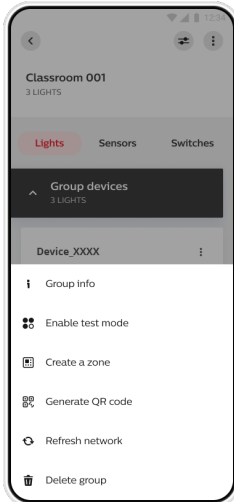

5.3



5.4

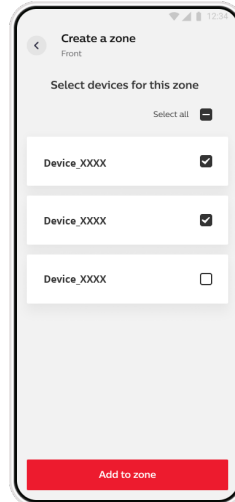

5.5

