

Hurdal Connect



220-240V~, 50/60Hz

SG Connect Commissioning

SG Connect User

GET IT ON Google Play

Download on the App Store

Range: 10m in open air

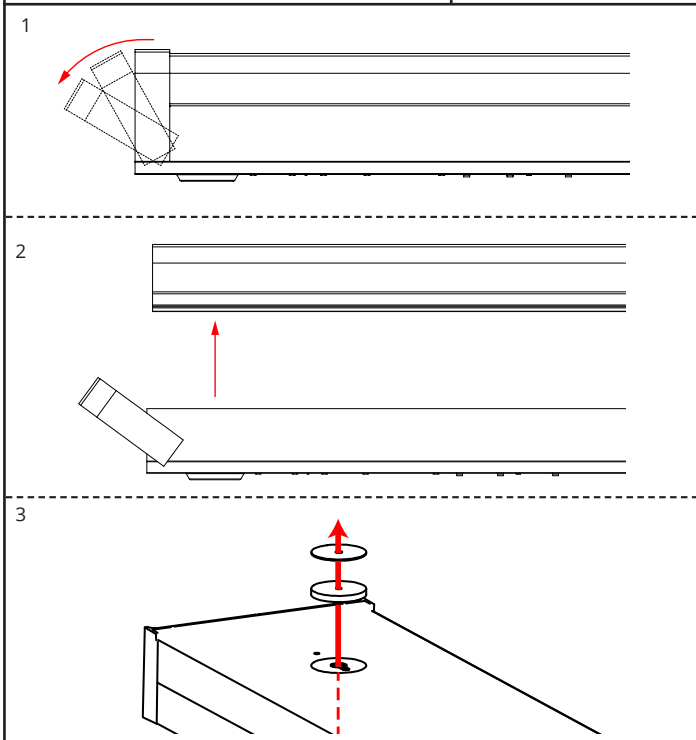

Hurdal	A	B	C	D
600	72mm	600mm	76mm	525mm
1200	72mm	1200mm	76mm	1100mm
1500	72mm	1500mm	76mm	1400mm

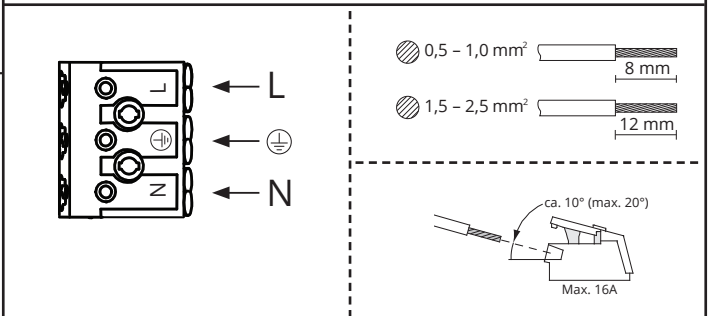

2: Replaceable (LED only) light source by a professional

3: Replaceable control gear by a professional

NO: Kan kun installeres og vedlikeholdes av en registrert installasjonsvirksomhet.

DK: Må kun installeres og vedligeholdes af uddannet elektriker.

SE: Skall installeras och underhållas av behörig elektriker.

EN: Only to be installed and maintained by an authorized electrician.

FR: Doit être installé et maintenu par un électricien qualifié.

NL: Mag alleen geïnstalleerd en onderhouden worden door een bevoegde electricien.

DE: Dieses Produkt darf nur durch autorisiertes Personal (z.B. Elektro-Installateur) angeschlossen, in Betrieb genommen und gewartet werden.

FI: Asentaa ja huoltaa saa vain valtuutettu sähköasentaja

NO: Skru av strømmen før montering.

DK: Sluk for strømmen inden montering.

SE: Stäng av strømmen innan montering.

EN: Turn off power before installing.

FR: Couper le courant avant l'installation.

NL: Stroom uitschakelen voor u het toestel installeert.

DE: Vor Installationsarbeiten den Strom abschalten.

FI: Sammuta virta ennen kytkemistä

NORWAY
SG Armaturen AS
Skytterheia 25
N-4790 Lillesand

SWEDEN
SG Armaturen AB
Tel: +46 31 81 71 10
info@sg-ab.se
www.sg-ab.se

DENMARK
SG Armaturen A/S
Tel: +45 70 70 72 13
info@sg-as.dk
www.sg-as.dk

FRANCE
SG Lighting SA/NV
Tel: +33(0) 4 94 93 00 00
info.france@sighting.net
www.sighting.net

GERMANY
SG Leuchten GmbH
Tel: +49 40 23 99 44 59
info@sg-leuchten.de
www.sg-leuchten.de

Tel: +47 37 50 03 00
firmapost@sg-as.no
www.sg-as.no

FINLAND
SG Armaturen Oy
Tel: +358 02 07 30 39 60
info@sg-oy.fi
www.sg-oy.fi

UNITED KINGDOM
SG Lighting LTD
Tel: +47 37 50 03 00
info@sighting.co.uk
www.sighting.co.uk

BENELUX
SG Lighting SA/NV
Tel: +32(0) 15 20 72 71
info.benelux@sighting.net
www.sighting.net

INTERNATIONAL
SG Lighting Co Ltd.
Tel: +86 769 88 49 20 88
cindy@sgdgc.com
www.sg-as.com

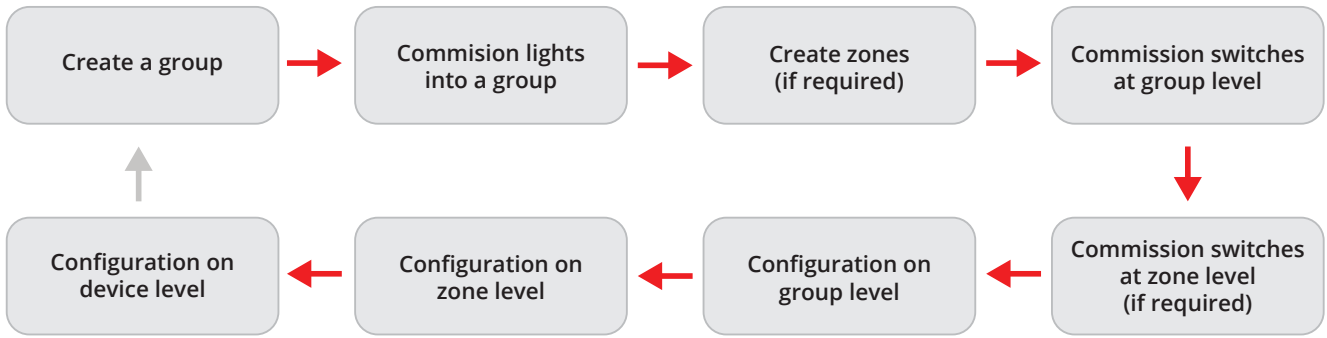

1 Login

1.1

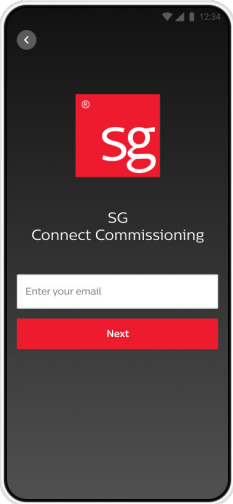

1.2

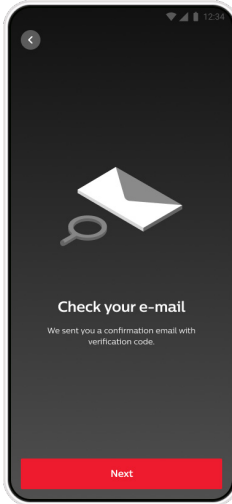

1.3

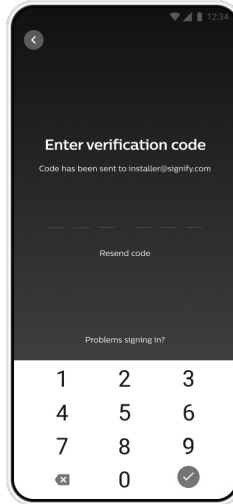

1.4

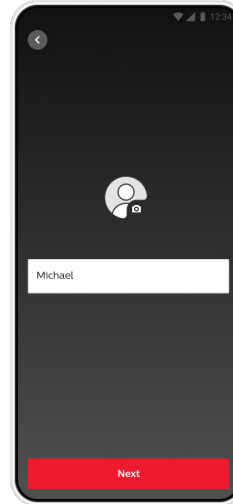

2 Create Group

2.1

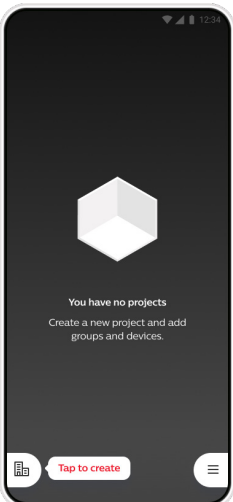

2.2

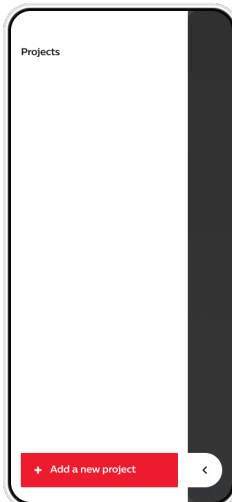

2.3

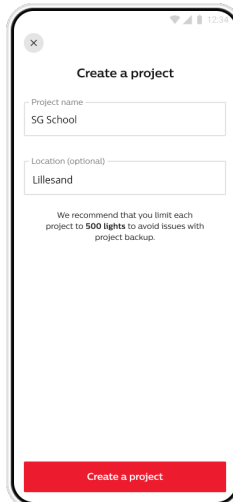

2.4

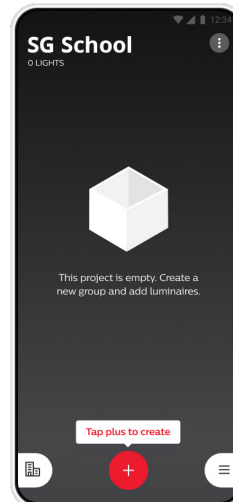

2.5

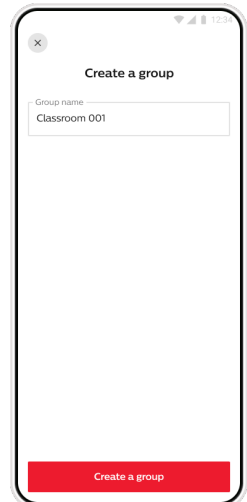

2.6

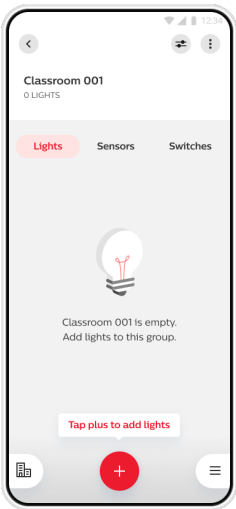

2.7



3 Torchlight Commissioning

3.1

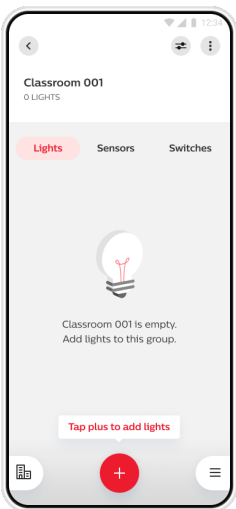

3.2

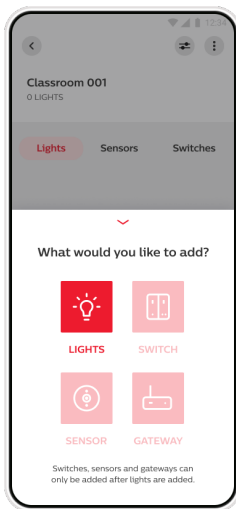

3.3

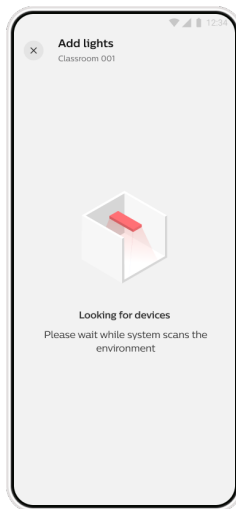

3.4

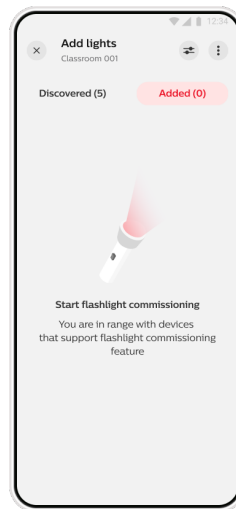

3.5

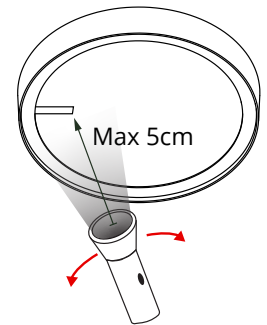

3.6

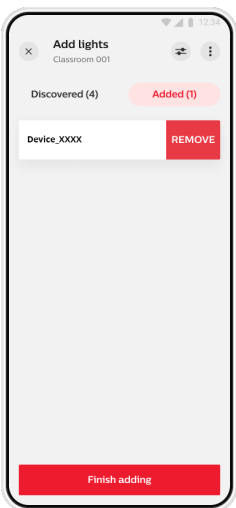

3.7

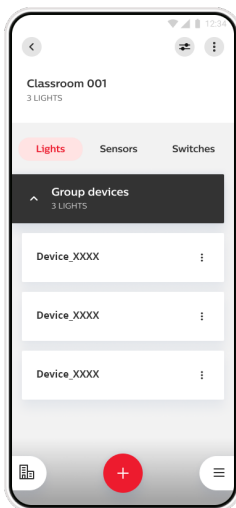

4 List Based Commissioning

4.1

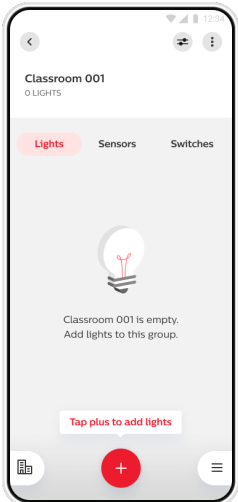

4.2

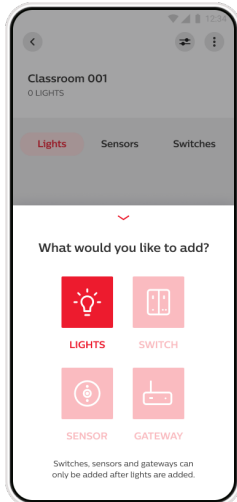

4.3

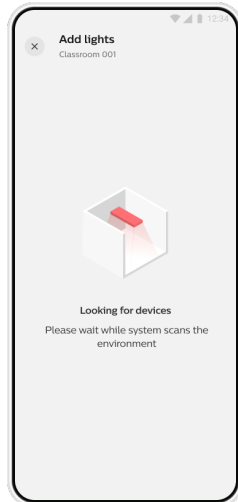

4.4

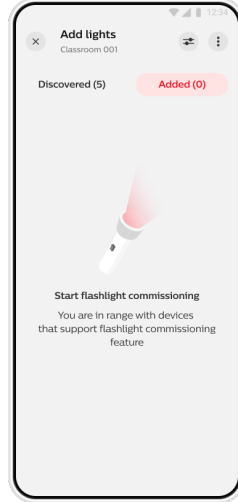

4.5

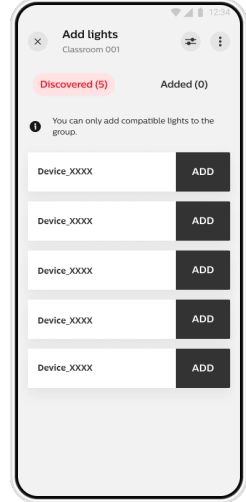

4.6

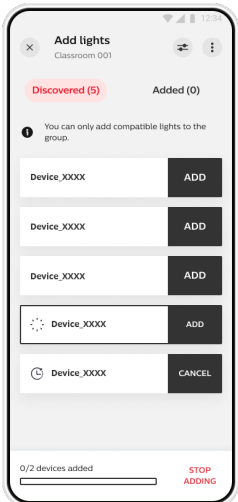

4.7

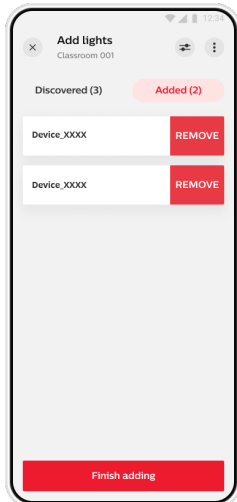

4.8

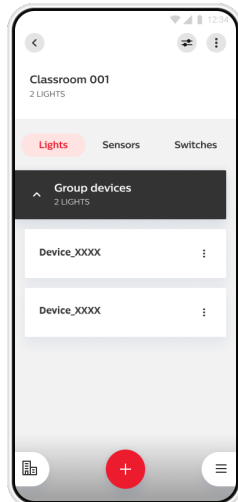

5 Create Zone

5.1

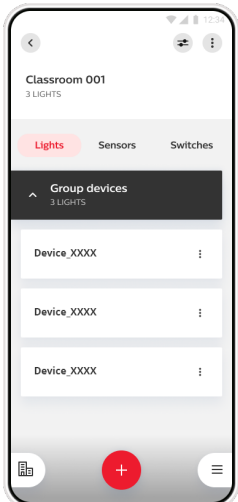

5.2

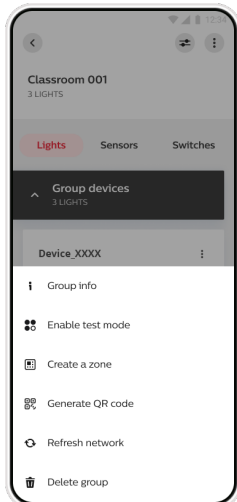

5.3

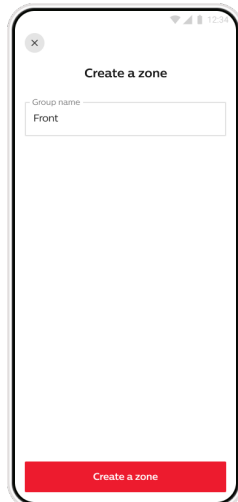

5.4

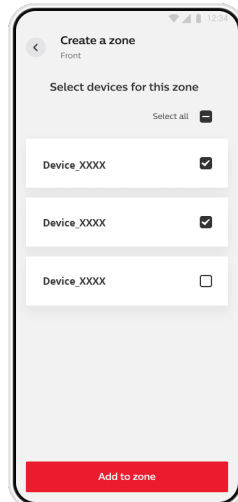

5.5

