

AX0 Category 6 and 6A UTP Jacks

Cat. Nos. AX61U and AX6AU



WARNINGS:

- **TO AVOID SHOCK OR ELECTROCUTION, DO NOT** push objects of any kind into this product, through openings, as they may touch dangerous voltages.
- **TO AVOID SHOCK OR ELECTROCUTION, DO NOT** touch uninsulated wires or terminals, unless the wiring has been disconnected at the network interface.
- **TO AVOID SHOCK OR ELECTROCUTION, DO NOT** install communications wiring or components during a lightning storm.
- Do not install or use this product near water (e.g., near a tub, wash basin, kitchen sink or laundry tub, in a wet basement, or near a swimming pool).

CAUTIONS:

- Use caution when installing or modifying communications wiring or components.
- Read, understand and save these all instructions. Follow all warnings and instructions marked on the product.
- If you are unsure about these installation instructions, contact an electrician.
- **SAVE THESE INSTRUCTIONS.**

PK-A3508-10-00-5A-W

INSTALLATION INSTRUCTIONS

ENGLISH

Product Description

The AX0 UTP jack is available in Category 6A and 6 and is designed to fit into Leviton's QUICKPORT® patch panels and wiring devices, as well as other Leviton patch panels and wiring devices. The AX0 jack includes universal color wiring labels for T568A and T568B and does not require a punchdown tool or proprietary termination tool to terminate. Only wire preparation tools are used.

Tools Required

- Data cable strip tool
- Flush cutter
- Small, flat-blade screwdriver

Features

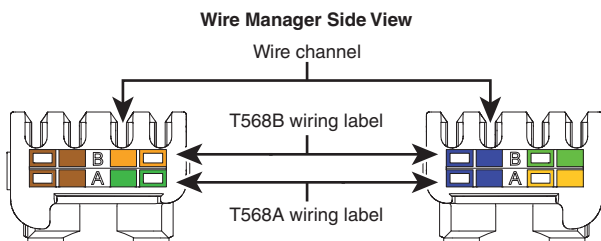
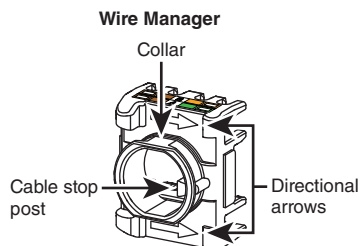
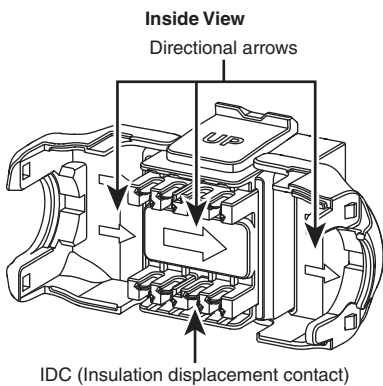
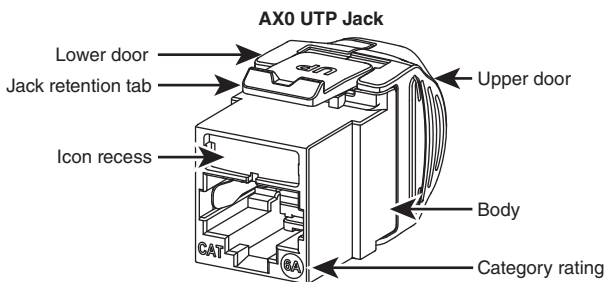

Cable Preparation

1. Use the data cable strip tool and remove 5 cm (2 in.) of the cable jacket.
NOTE: Make sure there is no damage to any pair insulation or conductor and adjust strip tool accordingly. If there is any damage, cut off the damaged area and strip the cable again.
2. Remove any isolation wraps, cross-separator, or strip string (any cable elements except for the insulated twisted pairs).
NOTE: Make sure there is no damage to any pair insulation or conductor. If there is any damage, cut off the damaged area and start the cable preparation again.

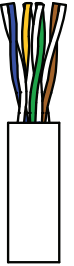

Dress Cable into Wire Manager

1. Observe the wiring label on the wire manager and select the "A" or "B" wiring method.

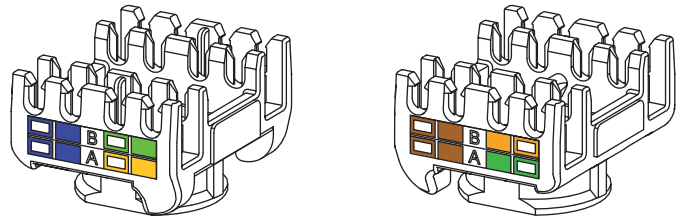

2. Align the blue pair with the blue wiring label on the wire manager.
NOTE: Aligning the blue pair leads to the optimal pair routing in the wire manager, improves jack performance and makes it easier to close the jack doors.
3. Pass the twisted pairs through the collar end of the wire manager until the strip point of the cable jacket rests against the cable jacket stop post.

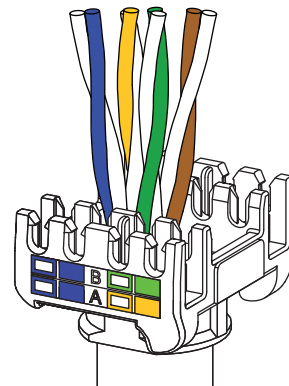

4. Arrange the pairs into position, as indicated on the wire manager's wiring label.

5. Untwist the protruding portion of each pair and pull wires into their wire slots. Observe the pair polarity indicated on the wiring label for each pair. The colored wire of the pair goes to the matching solid color block on the wire manager label. The white wire of the pair goes to the white block outlined with the color of the pair being positioned.

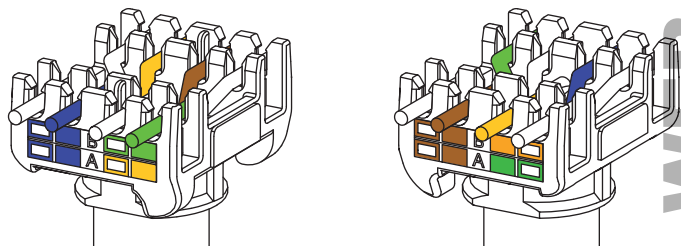

WEB VERSION

6. Before you use the flush cutter, do a polarity check:

For T568B wiring, the white wire of each pair, except for the green pair, should be toward the outside of the wire manager. For T568A wiring, the orange pair is the exception.

7. With a flush cutter, trim all the wires, flush with the sides of the wire manager.

NOTE: Flush cutting the pairs to the sides of the wire manager is a critical step. It improves jack performance and eases door closure.

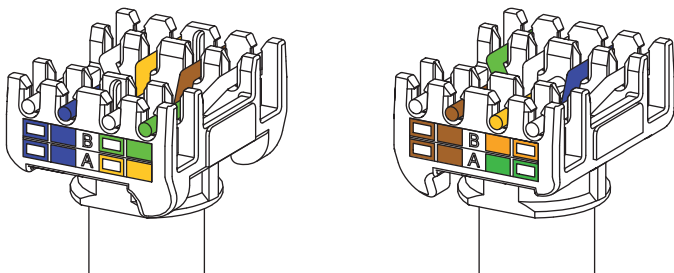

Terminating the Jack

1. Ensure that the jack Category rating (Cat 6 or Cat 6A) matches the rating of the cable being used.

2. Align the arrows on the prepared wire manager with the arrows on the jack.

NOTE: The brown pair side of the wire manager will be toward the jack retention tab.

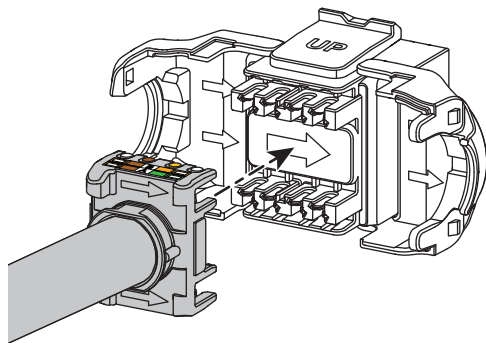

3. While holding the prepared wire manager against the rear of the jack and with the arrows aligned, close the jack doors to terminate the jack to the cable.

NOTE: One door begins to seat the wire manager, and then the other door engages. This is the normal and expected operation.

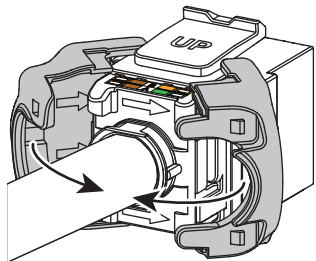

Preparing a Terminated Jack for Re-use

1. Place a flat-head screwdriver into the latches on the jack's doors and gently twist the screwdriver to unlatch them.

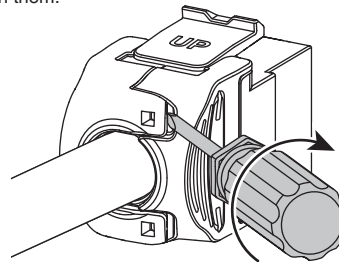

2. Place the flat-head screwdriver into the sides of the wire manager, gently pry at each side, and lift the wire manager to loosen the wires from the IDCs.

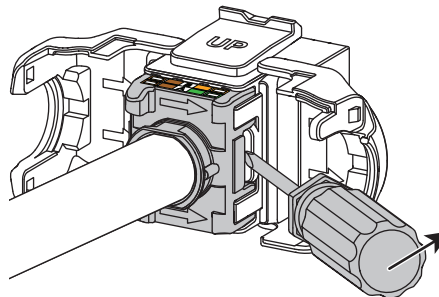

3. Carefully, lift the wire manager from the jack and remove the wires from the wire slots.

4. Make sure the IDCs are clear of any residual wire insulation fragments. The jack is ready for re-use.

Icons (Optional and Sold Separately)

The AX0 UTP jacks are black, but you may identify them by color with the addition of optional icons.

Icons are available in 13 colors and include the following messages: DATA, VOICE, AV (Audio-Video), a picture of a data terminal, picture of a telephone, and blank.

Leviton part number for icons: ICONS-ICx (x = color)

Installing Icons

1. Remove the desired icon from adjacent pieces, and scrape off any excess plastic from the edge of the icon.

2. Make sure the icon is in the correct orientation, and snap the icon onto the face of the jack.

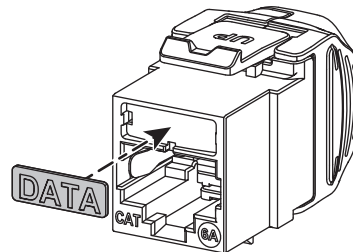

Removing Icons

1. Unbend a small paperclip.

2. Place the tip of the paperclip into the small hole at the base of the icon, and gently pry the icon out of the jack.

PATENT STATEMENT

Patents covering this product, if any, can be found on leviton.com/patents

TRADEMARK STATEMENT

LEVITON and LEVITON Block Design are trademarks of Leviton Manufacturing Co., Inc. and are registered trademarks in many countries throughout the world. QUICKPORT is a trademark of Leviton Manufacturing Co., Inc. and is registered in many countries including Australia, Bahrain, Canada, China, Columbia, Costa Rica, Egypt, the EU Member States, Hong Kong, Japan, Jordan, Kuwait, Mexico, New Zealand, Norway, Oman, Qatar, South Korea, Saudi Arabia, Singapore, Taiwan, United Arab Emirates, United Kingdom, United States, and Vietnam.

LIMITED 1 YEAR WARRANTY

For Leviton's limited 1 year product warranty, go to www.leviton.com. For a printed copy of the warranty, call 1-800-824-3005.

For Technical Assistance Call: +44 (0)1592 778494 (International) or 1-800-824-3005 (USA Only) www.leviton.com