

FLEKSIBEL LED INSTALLATION

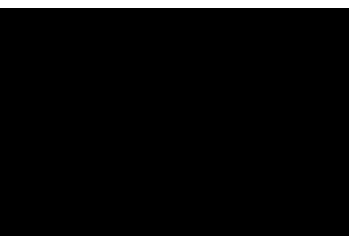

Indholdsfortegnelse

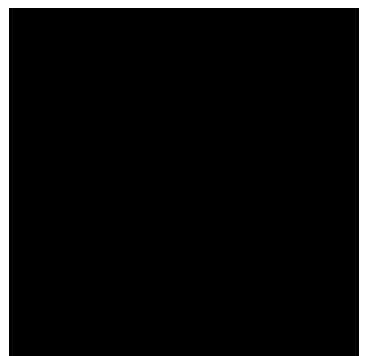
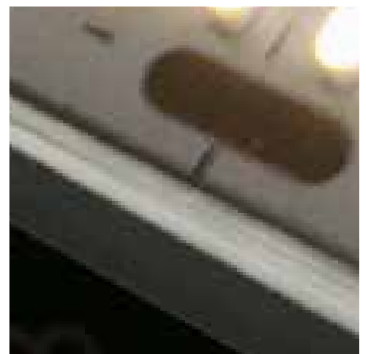
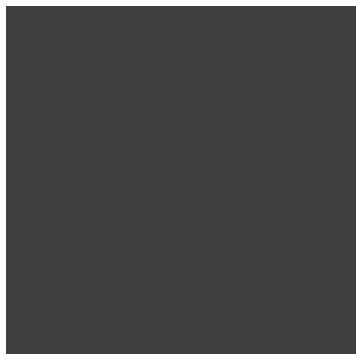
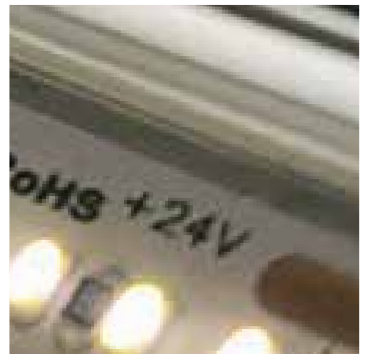

OVERSIGTER:

LED BÅNDSOVERSIGT	side 3
STRØMFORSYNINGSOVERSIGT	side 4 - 5
ALU. PROFILOVERSIGT	side 6 - 7

DATABLADE :

LED BÅND

LED bånd 4,8W/m - 360 Lm/m	side 08 - 11
LED bånd 9,4W/m - 720 Lm/m	side 12 - 15
LED bånd 14,4W/m - 1080 Lm/m	side 18 - 21
LED bånd IP68 14,4W/m - 1080 Lm/m	side 22 - 23
LED bånd 19,2W/m - 1440 Lm/m	side 24 - 27
LED bånd 14,4W/m - RGB og RGBW	side 28 - 31

STRØMFORSYNINGER

SNAPPY - optil 50W	side 34 - 39
SNAPPY - optil 320W	side 40 - 43
SNAPPY LONG	side 46 - 49
SNAPPY LONG - IP66	side 50 - 51
SNAPPY LOW HEIGHT - IP67	side 52 - 53
MEANWELL - IP67	side 54 - 57
DALI MEANWELL - IP67	side 59 - 61
DIN skinne	side 62 - 63
TRIAC DÆMPBAR	side 65 - 69

ALU. PROFILER

Alu. profil 2 & 5	side 72 - 73
Alu. profil 7 & 8	side 74 - 75
Alu. profil 9 & 10	side 76 - 77
Alu. profil 12 & 14	side 78 - 79
Alu. profil 20 & 23	side 80 - 81
Alu. fladprofil	side 82

24VDC LED bånd

med tætsiddende diode

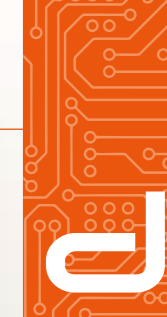

	Varenr.	EAN nr.	Type	VDC pr. meter	Watt pr. meter	Kelvin	IP	Dioder pr. meter	Klip pr. mm	Bånd brede i mm	Lumen pr. meter
4,8 WATT	VN640010x5	5713416003033	COO LED bånd	24V	4,8W	2700K	IP20	300DIO	20	10	360
	VN640011x5	5713416003040	COO LED bånd	24V	4,8W	3000K	IP20	300DIO	20	10	360
	VN640012x5	5713416003057	COO LED bånd	24V	4,8W	4000K	IP20	300DIO	20	10	360
	VN640013x5	5713416003064	COO LED bånd	24V	4,8W	6000K	IP20	300DIO	20	10	360
9,4 WATT	VN640020x5	5713416003071	COO LED bånd	24V	9,6W	2700K	IP20	300DIO	20	10	720
	VN640021x5	5713416003088	COO LED bånd	24V	9,6W	3000K	IP20	300DIO	20	10	720
	VN640022x5	5713416003095	COO LED bånd	24V	9,6W	4000K	IP20	300DIO	20	10	720
	VN640023x5	5713416003101	COO LED bånd	24V	9,6W	6000K	IP20	300DIO	20	10	720
14,4 WATT	VN640030x5	5713416003118	COO LED bånd	24V	14,4W	2700K	IP20	300DIO	20	10	1080
	VN640031x5	5713416003125	COO LED bånd	24V	14,4W	3000K	IP20	300DIO	20	10	1080
	VN640032x5	5713416003132	COO LED bånd	24V	14,4W	4000K	IP20	300DIO	20	10	1080
	VN640033x5	5713416003149	COO LED bånd	24V	14,4W	6000K	IP20	300DIO	20	10	1080
	VN640034x5	5713416003156	COO LED bånd	24V	14,4W	3000K	IP68	300DIO	20	10	1080
	VN640035x5	5713416003163	COO LED bånd	24V	14,4W	4000K	IP68	300DIO	20	10	1080
19,2 WATT	VN640040x5	5713416003170	COO LED bånd	24V	19,2W	2700K	IP20	300DIO	20	10	1440
	VN640041x5	5713416003187	COO LED bånd	24V	19,2W	3000K	IP20	300DIO	20	10	1440
	VN640042x5	5713416003194	COO LED bånd	24V	19,2W	4000K	IP20	300DIO	20	10	1440
	VN640043x5	5713416003200	COO LED bånd	24V	19,2W	6000K	IP20	300DIO	20	10	1440
	VN640050x5	5713416003217	COO LED bånd	24V	14,4W	RGB	IP20	120DIO	50	12	-
	VN640051x5	5713416003224	COO LED bånd	24V	14,4W	RGB	IP68	120DIO	50	12	-
	VN600098x5	5713416003958	LED bånd	24V	30W	RGBW	IP20	96DIO	63	12	-
	VN600099x5	5713416003941	LED bånd	24V	30W	RGBW	IP67	96DIO	63	12	-

IP ER TÆTHEDSGRADEN

IP20: Ubeskyttet - skal placeres tørt.
 IP67: Støvtæt og vandtæt - kan holde tæt ned til 1 meters dybde i op til 30 min.
 IP68: Støvtæt og vandtæt - kan holde tæt ved kontinuerlig nedsænkning i vand.

IP

(Ingress Protection)

Evnen til at tåle vand og fremmedlegemer.

24VDC Strømforsyninger



SNAPPY

VARENR.	EAN NR.	NAVN	TYPE	UDGANGSSTRØM	IP	UDGANGSEFFEKT
VN600240	5713416000711	24VDC LED PS 6W	Snappy	0,25A	IP20	6W
VN600241	5713416000728	24VDC LED PS 12W	Snappy	0,5A	IP20	12W
VN600220	5713416000735	24VDC LED PS 15W	Snappy	0,62A	IP20	15W
VN600200	5713416002777	24VDC LED PS 20W	Snappy	0,84A	IP20	20W
VN600201	5713416000742	24VDC LED PS 30W	Snappy	1,25A	IP20	30W
VN600244	5713416000766	24VDC LED PS 50W	Snappy	2,05A	IP20	50W
VN600245	5713416000780	24VDC LED PS 75W	Snappy	3,12A	IP20	75W
VN600286	5713416003804	24VDC LED PS 150W	Snappy	6,25A	IP20	150W
VN600270	5713416002616	24VDC LED PS 250W	Snappy	10,4A	IP20	250W
VN600271	5713416002623	24VDC LED PS 320W	Snappy	13,3A	IP20	320W

LONG

VN600246	5713416002708	24VDC LED PS 60W	Snappy LONG	2,5A	IP20	60W
VN600264	5713416002524	24VDC LED PS 150W	Snappy LONG	6,25A	IP20	150W
VN600281	5713416002975	24VDC LED PS 200W	Snappy LONG	8,33A	IP20	200W
VN600282	5713416002982	24VDC LED PS 240W	Snappy LONG	10A	IP20	240W

LONG IP66

VN600267	5713416002548	24VDC LED PS 60W	Snappy LONG	2,5A	IP66	60W
VN600269	5713416002555	24VDC LED PS 150W	Snappy LONG	6,25A	IP66	150W

LOW HEIGHT

VN600284	5713416003019	24VDC LED PS 200W SPH	LOW height	8,3A	IP67	200W
VN600285	5713416003026	24VDC LED PS 320W SPH	LOW height	13,3A	IP67	320W

BELASTNING!

Belast aldrig din strømforsyning med mere end **90%**

24VDC Strømforsyninger



MEANWELL

VARENR.	EAN NR.	NAVN	TYPE	UDGANGSSTRØM	IP	UDGANGSEFFEKT
VN600253	5713416000797	24VDC LED PS 75W	Mean Well	3,15A	IP67	75W
VN600210	5713416000827	24VDC LED PS 150W	Mean Well	6,25A	IP67	150W
VN600212	5713416000841	24VDC LED PS 200W	Mean Well	8,4A	IP67	200W
VN600217	5713416000858	24VDC LED PS 320W	Mean Well	13,3A	IP67	320W

DALI

VN600279	5713416000803	24VDC LED PS 75W IP67	Meanwell DALI	3,15A	IP67	75W
VN600250	5713416000834	24VDC LED PS 150W IP67	Meanwell DALI	6,25A	IP67	150W
VN600259	5713416002951	24VDC LED PS 200W IP67	Meanwell DALI	8,4A	IP67	200W

DIN

VN600292	5713416003378	24VDC LED PS 60W - DIN	Meanwell DIN-RAIL	2,5A	IP20	60W
VN600291	5713416003385	24VDC LED PS 100W - DIN	Meanwell DIN-RAIL	3,83A	IP20	100W

TRIAC DÆMPBAR

VARENR.	EAN NR.	NAVN	TYPE	UDGANGSSTRØM	IP	UDGANGSEFFEKT
VN600280	5713416002838	24VDC LED PS 50W	Dæmpbar Snappy	2,08A	IP20	50W
VN600283	5713416002999	24VDC LED PS 75W	Dæmpbar Snappy	3,12A	IP20	75W
VN600273	5713416002661	24VDC LED PS 80W IP66	SC Dæmpbar	3,33A	IP66	80W
VN600274	5713416002678	24VDC LED PS 150W IP66	SC Dæmpbar	6,25A	IP66	150W
VN600275	5713416002685	24VDC LED PS 320W IP66	SC Dæmpbar	13,33A	IP66	320W



IP67
DALI
DIN
DÆMPBAR

Aluminiumsprofiler



PROFIL	VARENR.	EAN NR.	BESKRIVELSE
2 PROFIL	LM27102	5713416001114	Alu. profil 2, m/opal cover - 2500 mm
	LM27302	5713416001121	Alu. profil 2, m/klar cover - 2500 mm
	VN27102x1	5713416001138	Endeprop med hul for ledning
	VN27102x2	5713416001145	Endeprop uden hul
	VN27102x3	5713416001152	Clips t/montage
5 PROFIL	LM27105	5713416001213	Alu. profil 5, m/opal cover - 2500 mm
	LM27305	5713416001220	Alu. profil 5, m/klar cover - 2500 mm
	VN27105x1	5713416001237	Endeprop med hul for ledning
	VN27105x2	5713416001244	Endeprop uden hul
	VN27105x3	5713416002203	Clips t/montage
7 PROFIL	LM27107	5713416001251	Alu. profil 7, m/opal cover - 2500 mm
	LM27307	5713416001268	Alu. profil 7, m/klar cover - 2500 mm
	VN27107x1	5713416001275	Endeprop m/hul for ledning
	VN27107x2	5713416001282	Endeprop u/hul
	VN27107x3	5713416001299	Clips t/montage
8 PROFIL	LM27108	5713416001305	Alu. profil 8, m/opal cover - 2500 mm
	LM27308	5713416001312	Alu. profil 8, m/klar cover - 2500 mm
	VN27108x1	5713416001329	Endeprop m/hul for ledning
	VN27108x2	5713416001336	Endeprop u/hul
	VN27108x3	5713416001343	Clips t/montage
9 PROFIL	LM27109	5713416001350	Alu. profil 9, m/opalcover - 2500 mm
	LM27309	5713416001367	Alu. profil 9, m/klar cover - 2500 mm
	VN27109x1	5713416001374	Endeprop m/hul for ledning
	VN27109x2	5713416001381	Endeprop u/hul
	VN27109x3	5713416001398	Clips t/montage
10 PROFIL	LM27110	5713416001404	Alu. profil 10, m/opal cover - 2500 mm
	LM27310	5713416001411	Alu. profil 10, m/klar cover - 2500 mm
	VN27110x1	5713416001428	Endeprop m/hul for ledning
	VN27110x2	5713416001435	Endeprop u/hul
	VN27110x3	5713416001442	Clips t/montage

Aluminiumsprofiler



PROFIL	VARENR.	EAN NR.	BESKRIVELSE
12 PROFIL	LM27112	5713416001466	Alu. profil 12, m/opal cover - 2500 mm
	LM27312	5713416001459	Alu. profil 12, m/klar cover - 2500 mm
	VN27112x1	5713416001473	Endeprop m/hul for ledning
	VN27112x2	5713416001480	Endeprop u/hul
	VN27112x3	5713416001497	Clips t/montage
14 PROFIL	LM27114	5713416001503	Alu. profil 14, m/opal cover - 2500 mm
	LM27314	5713416001510	Alu. profil 14, m/klar cover - 2500 mm
	VN27114x1	5713416001527	Endeprop m/hul for ledning
	VN27114x2	5713416001534	Endeprop u/hul
	-	-	Leveres MED montageskinne.
20 PROFIL	LM27120	5713416001572	Alu. profil 20, m/opal cover - 2500 mm
	LM27320	5713416001589	Alu. profil 20, m/klar cover - 2500 mm
	VN27120x2	5713416002210	Endeprop u/hul
	-	-	Leveres UDEN clips.
	-	-	Clips - eksistere ikke!
23 PROFIL	LM27123	5713416003392	Alu. profil 23, m/frostet cover - 2500 mm
	VN27123x1	5713416003408	Endeprop m/hul for ledning
	VN27123x2	5713416003415	Endeprop u/hul
	VN27123x3	5713416003422	Clips t/montage
	RÅ PROFIL	LM27002	5713416001558
LM27001		5713416001565	Alu. flad-profil 20 x 2 x 2500 mm flad/rå for afkøling

24V LED BÅND · 300 DIODER/M

2700K · 4,8W · IP20



Varenr.: 640010

Watt / pr. meter: 4,8
 Spænding / Vdc: 24
 Kelvin / K: 2700
 Lumen / pr. meter: 360

RA / CRI - Nom.: >90
 Tætningsklasse / IP: 20
 LED / stk. pr. meter: 300
 Lys spredning / grader: 120

Dæmpbar: Ja
 (Dæmper skal tilkøbes)

Klippemærke afstand / mm: 20
 Båndbredde / mm: 10
 Båndlængde / m. pr. rulle: 5

Levetid / timer: 50.000

Foto:

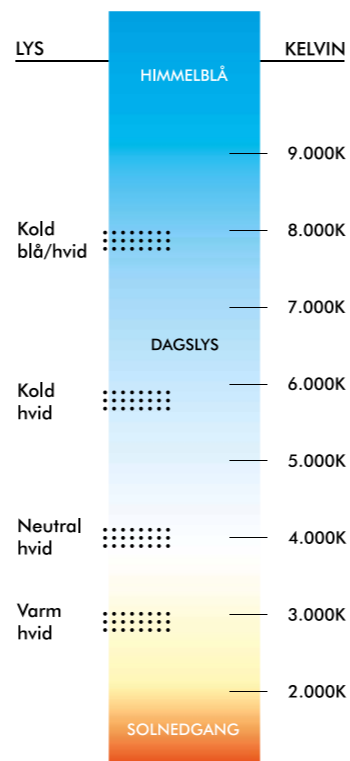

RoHS

24V LED BÅND · 300 DIODER/M

3000K · 4,8W · IP20



Varenr.: 640011

Watt / pr. meter: 4,8
 Spænding / Vdc: 24
 Kelvin / K: 3000
 Lumen / pr. meter: 360

RA / CRI - Nom.: >90
 Tætningsklasse / IP: 20
 LED / stk. pr. meter: 300
 Lys spredning / grader: 120

Dæmpbar: Ja
 (Dæmper skal tilkøbes)

Klippemærke afstand / mm: 20
 Båndbredde / mm: 10
 Båndlængde / m. pr. rulle: 5

Levetid / timer: 50.000

Foto:

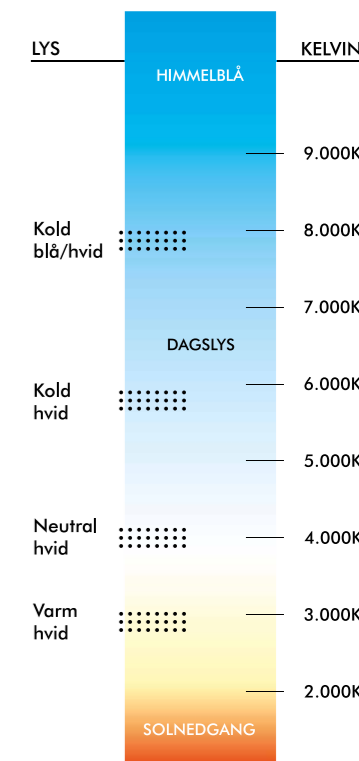

RoHS

24V LED BÅND · 300 DIODER/M

4000K · 4,8W · IP20



Varenr.: 640012

Watt / pr. meter: 4,8
 Spænding / Vdc: 24
 Kelvin / K: 4000
 Lumen / pr. meter: 360

RA / CRI - Nom.: >90
 Tætningsklasse / IP: 20
 LED / stk. pr. meter: 300
 Lys spredning / grader: 120

Dæmpbar: Ja
 (Dæmper skal tilkøbes)

Klippemærke afstand / mm: 20
 Båndbredde / mm: 10
 Båndlængde / m. pr. rulle: 5

Levetid / timer: 50.000

Foto:

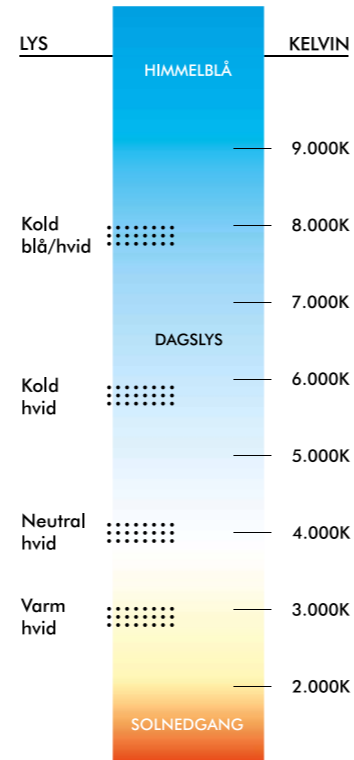
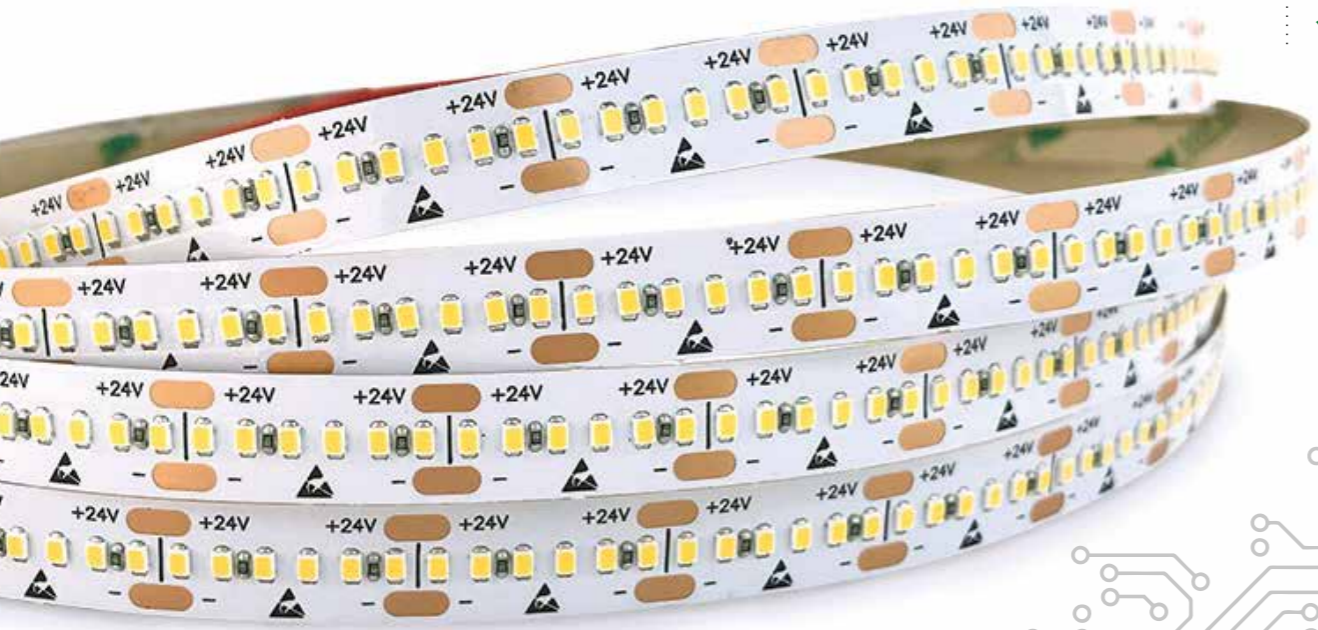

RoHS

24V LED BÅND · 300 DIODER/M

6000K · 4,8W · IP20



Varenr.: 640013

Watt / pr. meter: 4,8
 Spænding / Vdc: 24
 Kelvin / K: 6000
 Lumen / pr. meter: 360

RA / CRI - Nom.: >90
 Tætningsklasse / IP: 20
 LED / stk. pr. meter: 300
 Lys spredning / grader: 120

Dæmpbar: Ja
 (Dæmper skal tilkøbes)

Klippemærke afstand / mm: 20
 Båndbredde / mm: 10
 Båndlængde / m. pr. rulle: 5

Levetid / timer: 50.000

Foto:

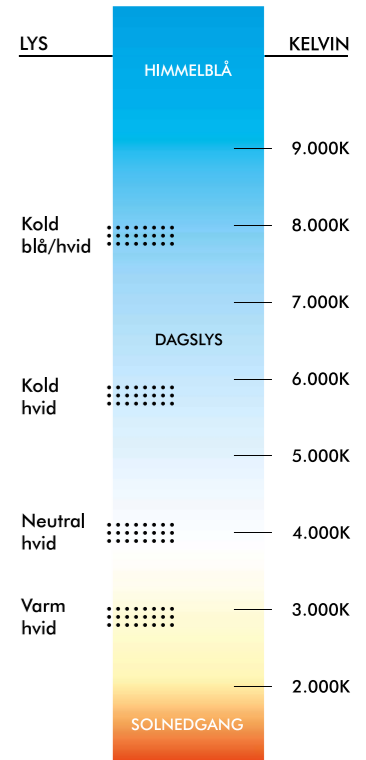

RoHS

24V LED BÅND · 300 DIODER/M

2700K · 9,6W · IP20



Varenr.: 640020

Watt / pr. meter: 9,6
 Spænding / Vdc: 24
 Kelvin / K: 2700
 Lumen / pr. meter: 720

RA / CRI - Nom.: >90
 Tætningsklasse / IP: 20
 LED / stk. pr. meter: 300
 Lys spredning / grader: 120

Dæmpbar: Ja
 (Dæmper skal tilkøbes)

Klippemærke afstand / mm: 20
 Båndbredde / mm: 10
 Båndlængde / m. pr. rulle: 5

Levetid / timer: 50.000

Foto:

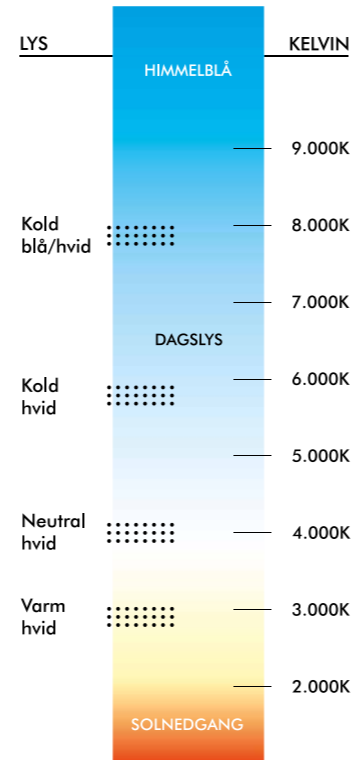
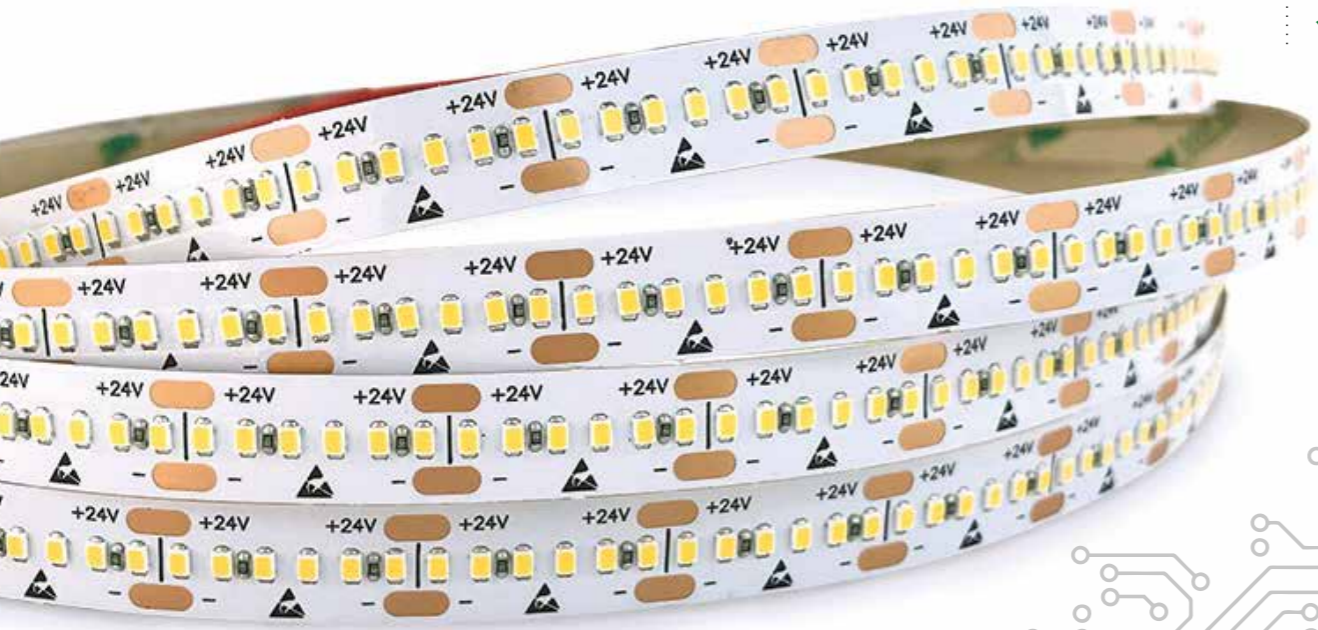

RoHS

24V LED BÅND · 300 DIODER/M

3000K · 9,6W · IP20



Varenr.: 640021

Watt / pr. meter: 9,6
 Spænding / Vdc: 24
 Kelvin / K: 3000
 Lumen / pr. meter: 720

RA / CRI - Nom.: >90
 Tætningsklasse / IP: 20
 LED / stk. pr. meter: 300
 Lys spredning / grader: 120

Dæmpbar: Ja
 (Dæmper skal tilkøbes)

Klippemærke afstand / mm: 20
 Båndbredde / mm: 10
 Båndlængde / m. pr. rulle: 5

Levetid / timer: 50.000

Foto:

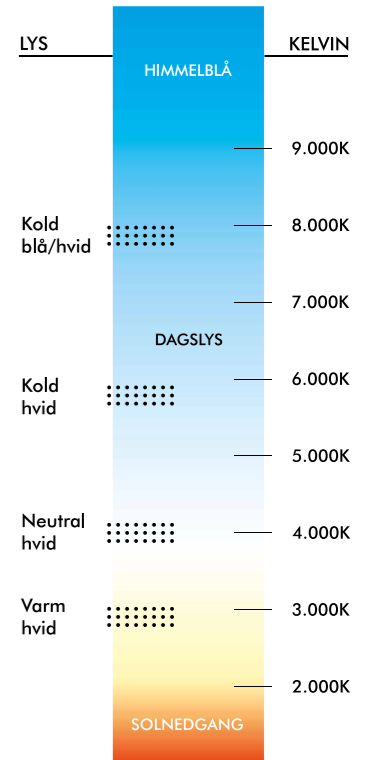

RoHS

24V LED BÅND · 300 DIODER/M

4000K · 9,6W · IP20



Varenr.: 640022

Watt / pr. meter: 9,6
 Spænding / Vdc: 24
 Kelvin / K: 4000
 Lumen / pr. meter: 720

RA / CRI - Nom.: >90
 Tætningsklasse / IP: 20
 LED / stk. pr. meter: 300
 Lys spredning / grader: 120

Dæmpbar: Ja
 (Dæmper skal tilkøbes)

Klippemærke afstand / mm: 20
 Båndbredde / mm: 10
 Båndlængde / m. pr. rulle: 5

Levetid / timer: 50.000

Foto:

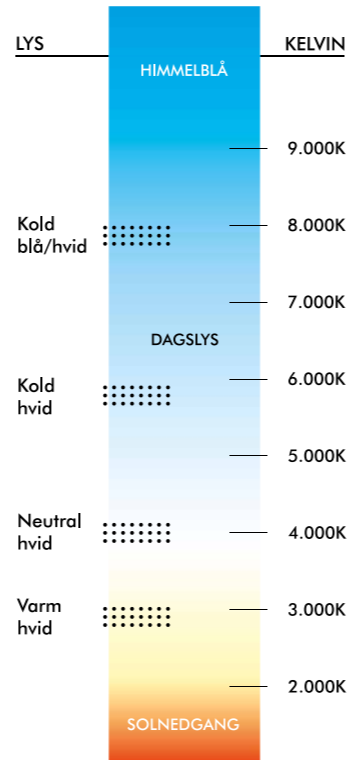

RoHS

24V LED BÅND · 300 DIODER/M

6000K · 9,6W · IP20



Varenr.: 640023

Watt / pr. meter: 9,6
 Spænding / Vdc: 24
 Kelvin / K: 6000
 Lumen / pr. meter: 720

RA / CRI - Nom.: >90
 Tætningsklasse / IP: 20
 LED / stk. pr. meter: 300
 Lys spredning / grader: 120

Dæmpbar: Ja
 (Dæmper skal tilkøbes)

Klippemærke afstand / mm: 20
 Båndbredde / mm: 10
 Båndlængde / m. pr. rulle: 5

Levetid / timer: 50.000

Foto:

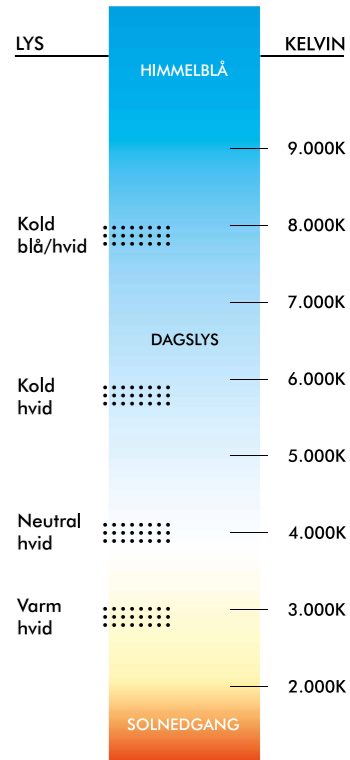

RoHS



24V LED BÅND · 300 DIODER/M

2700K · 14,4W · IP20



Varenr.: 640030

Watt / pr. meter: 14,4
 Spænding / Vdc: 24
 Kelvin / K: 2700
 Lumen / pr. meter: 1080

RA / CRI - Nom.: >90
 Tætningsklasse / IP: 20
 LED / stk. pr. meter: 300
 Lys spredning / grader: 120

Dæmpbar: Ja
 (Dæmper skal tilkøbes)

Klippemærke afstand / mm: 20
 Båndbredde / mm: 10
 Båndlængde / m. pr. rulle: 5

Levetid / timer: 50.000

Foto:

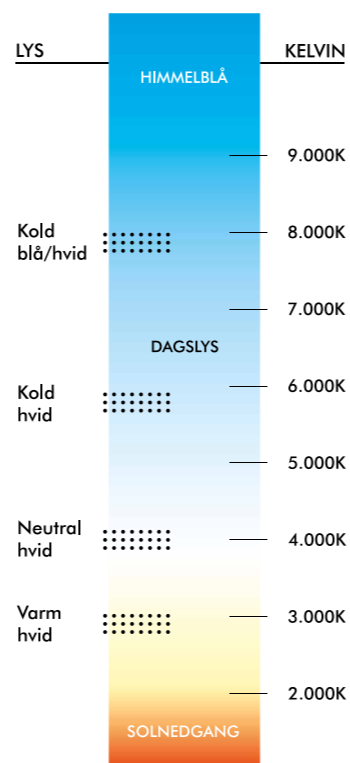

RoHS

24V LED BÅND · 300 DIODER/M

3000K · 14,4W · IP20



Varenr.: 640031

Watt / pr. meter: 14,4
 Spænding / Vdc: 24
 Kelvin / K: 3000
 Lumen / pr. meter: 1080

RA / CRI - Nom.: >90
 Tætningsklasse / IP: 20
 LED / stk. pr. meter: 300
 Lys spredning / grader: 120

Dæmpbar: Ja
 (Dæmper skal tilkøbes)

Klippemærke afstand / mm: 20
 Båndbredde / mm: 10
 Båndlængde / m. pr. rulle: 5

Levetid / timer: 50.000

Foto:

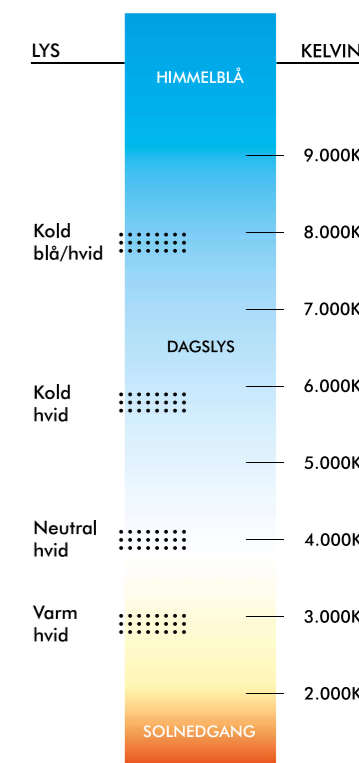

RoHS

24V LED BÅND · 300 DIODER/M

4000K · 14,4W · IP20



Varenr.: 640032

Watt / pr. meter: 14,4
 Spænding / Vdc: 24
 Kelvin / K: 4000
 Lumen / pr. meter: 1080

RA / CRI - Nom.: >90
 Tætningsklasse / IP: 20
 LED / stk. pr. meter: 300
 Lys spredning / grader: 120

Dæmpbar: Ja
 (Dæmper skal tilkøbes)

Klippemærke afstand / mm: 20
 Båndbredde / mm: 10
 Båndlængde / m. pr. rulle: 5

Levetid / timer: 50.000

Foto:

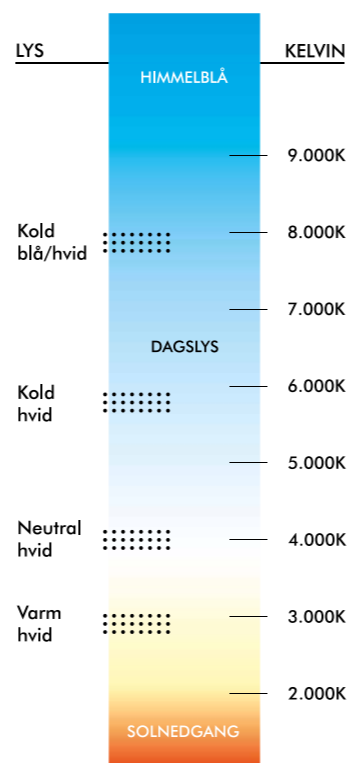

RoHS

24V LED BÅND · 300 DIODER/M

6000K · 14,4W · IP20



Varenr.: 640033

Watt / pr. meter: 14,4
 Spænding / Vdc: 24
 Kelvin / K: 6000
 Lumen / pr. meter: 1080

RA / CRI - Nom.: >90
 Tætningsklasse / IP: 20
 LED / stk. pr. meter: 300
 Lys spredning / grader: 120

Dæmpbar: Ja
 (Dæmper skal tilkøbes)

Klippemærke afstand / mm: 20
 Båndbredde / mm: 10
 Båndlængde / m. pr. rulle: 5

Levetid / timer: 50.000

Foto:

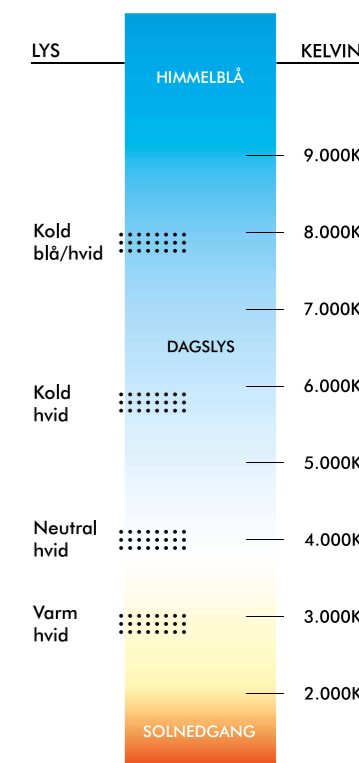

RoHS

24V LED BÅND · 300 DIODER/M

3000K · 14,4W · IP68

LED

Varenr.: 640034

Watt / pr. meter: 14,4
 Spænding / Vdc: 24
 Kelvin / K: 3000
 Lumen / pr. meter: 1080

RA / CRI - Nom.: >90
 Tætningsklasse / IP: 68
 LED / stk. pr. meter: 300
 Lys spredning / grader: 120

Dæmpbar: Ja
 (Dæmper skal tilkøbes)

Klippemærke afstand / mm: 20
 Båndbredde / mm: 12
 Båndlængde / m. pr. rulle: 5

Levetid / timer: 50.000

Foto:

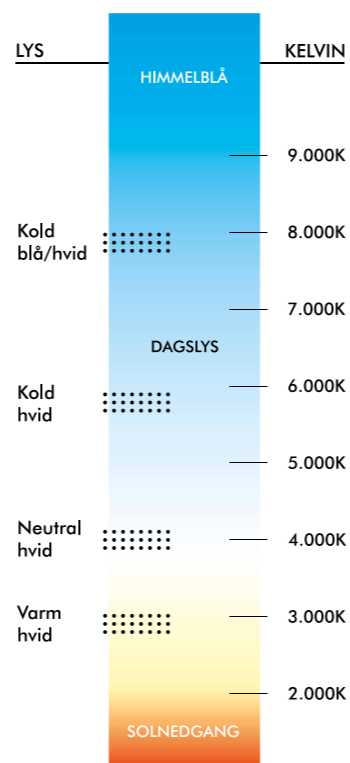

RoHS

24V LED BÅND · 300 DIODER/M

4000K · 14,4W · IP68

LED

Varenr.: 640035

Watt / pr. meter: 14,4
 Spænding / Vdc: 24
 Kelvin / K: 4000
 Lumen / pr. meter: 1080

RA / CRI - Nom.: >90
 Tætningsklasse / IP: 68
 LED / stk. pr. meter: 300
 Lys spredning / grader: 120

Dæmpbar: Ja
 (Dæmper skal tilkøbes)

Klippemærke afstand / mm: 20
 Båndbredde / mm: 12
 Båndlængde / m. pr. rulle: 5

Levetid / timer: 50.000

Foto:

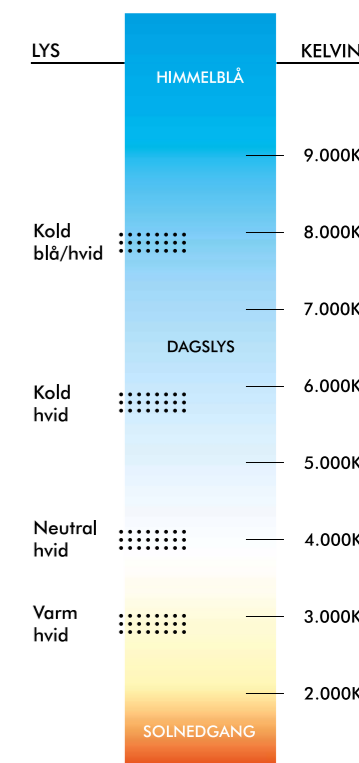

RoHS

24V LED BÅND · 300 DIODER/M

2700K · 19,2W · IP20



Varenr.: 640040

Watt / pr. meter: 19,2
 Spænding / Vdc: 24
 Kelvin / K: 2700
 Lumen / pr. meter: 1440

RA / CRI - Nom.: >90
 Tætningsklasse / IP: 20
 LED / stk. pr. meter: 300
 Lys spredning / grader: 120

Dæmpbar: Ja
 (Dæmper skal tilkøbes)

Klippemærke afstand / mm: 20
 Båndbredde / mm: 10
 Båndlængde / m. pr. rulle: 5

Levetid / timer: 50.000

Foto:

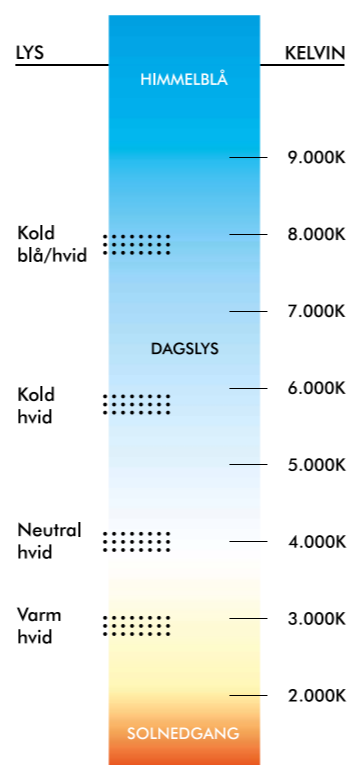

RoHS

24V LED BÅND · 300 DIODER/M

3000K · 19,2W · IP20



Varenr.: 640041

Watt / pr. meter: 19,2
 Spænding / Vdc: 24
 Kelvin / K: 3000
 Lumen / pr. meter: 1440

RA / CRI - Nom.: >90
 Tætningsklasse / IP: 20
 LED / stk. pr. meter: 300
 Lys spredning / grader: 120

Dæmpbar: Ja
 (Dæmper skal tilkøbes)

Klippemærke afstand / mm: 20
 Båndbredde / mm: 10
 Båndlængde / m. pr. rulle: 5

Levetid / timer: 50.000

Foto:

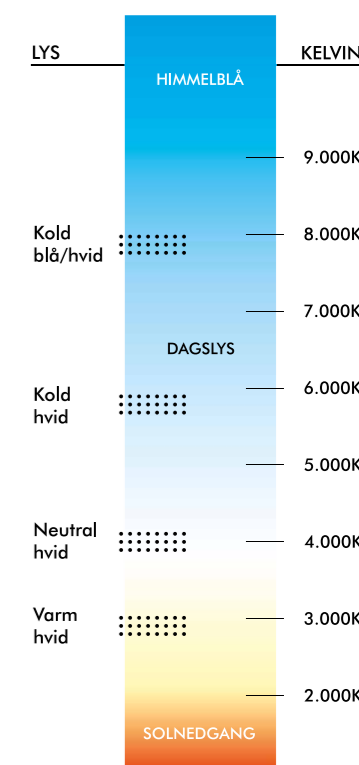

RoHS

24V LED BÅND · 300 DIODER/M

4000K · 19,2W · IP20



Varenr.: 640042

Watt / pr. meter: 19,2
 Spænding / Vdc: 24
 Kelvin / K: 4000
 Lumen / pr. meter: 1440

RA / CRI - Nom.: >90
 Tætningsklasse / IP: 20
 LED / stk. pr. meter: 300
 Lys spredning / grader: 120

Dæmpbar: Ja
 (Dæmper skal tilkøbes)

Klippemærke afstand / mm: 20
 Båndbredde / mm: 10
 Båndlængde / m. pr. rulle: 5

Levetid / timer: 50.000

Foto:

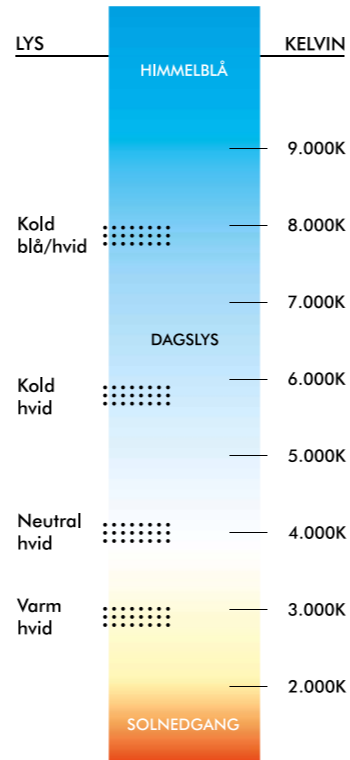
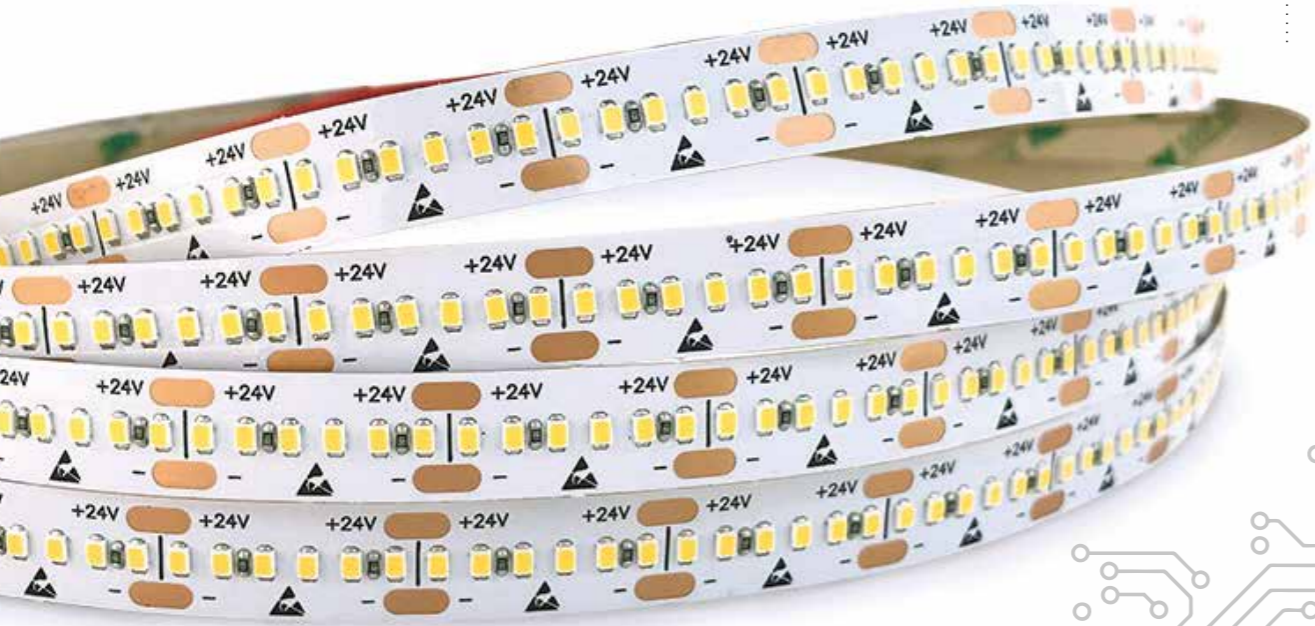

RoHS

24V LED BÅND · 300 DIODER/M

6000K · 19,2W · IP20



Varenr.: 640043

Watt / pr. meter: 19,2
 Spænding / Vdc: 24
 Kelvin / K: 6000
 Lumen / pr. meter: 1440

RA / CRI - Nom.: >90
 Tætningsklasse / IP: 20
 LED / stk. pr. meter: 300
 Lys spredning / grader: 120

Dæmpbar: Ja
 (Dæmper skal tilkøbes)

Klippemærke afstand / mm: 20
 Båndbredde / mm: 10
 Båndlængde / m. pr. rulle: 5

Levetid / timer: 50.000

Foto:

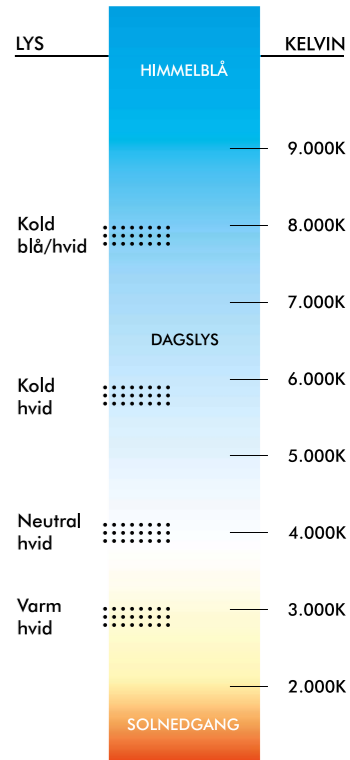

RoHS

24V LED BÅND · RGB

14,4W · IP20

Varenr.: 640050

Watt / pr. meter: 14,4
 Spænding / Vdc: 24
 Farve: RGB

Tætningsklasse / IP: 20
 LED / stk. pr. meter: 120
 Lys spredning / grader: 120

Dæmpbar: Ja
 (Dæmper skal tilkøbes)

Klippemærke afstand / mm: 50
 Båndbredde / mm: 12
 Båndlængde / m. pr. rulle: 5

Levetid / timer: 50.000



Foto:



RoHS



24V LED BÅND · RGB

14,4W · IP68

Varenr.: 640051

Watt / pr. meter: 14,4
 Spænding / Vdc: 24
 Farve: RGB

Tætningsklasse / IP: 68
 LED / stk. pr. meter: 120
 Lys spredning / grader: 120

Dæmpbar: Ja
 (Dæmper skal tilkøbes)

Klippemærke afstand / mm: 50
 Båndbredde / mm: 12
 Båndlængde / m. pr. rulle: 5

Levetid / timer: 50.000



Foto:



RoHS



24V LED BÅND · RGB+VARM HVID

RGBW · 30W · IP20

LED

Varenr.: 600098

Watt / pr. meter: 30
 Spænding / Vdc: 24
 Farve: RGBWW

Tætningsklasse / IP: 20
 LED / stk. pr. meter: 96
 Lys spredning / grader: 120

Dæmpbar: Ja
 (Dæmper skal tilkøbes)

Klippemærke afstand / mm: 63
 Båndbredde / mm: 12
 Båndlængde / m. pr. rulle: 5
 Ledning i begge ender: 3 meter 5 x 0,4 mm²

Levetid / timer: 50.000



Foto:



RoHS

24V LED BÅND · RGB+VARM HVID

RGBW · 30W · IP67

LED

Varenr.: 600099

Watt / pr. meter: 30
 Spænding / Vdc: 24
 Farve: RGBWW

Tætningsklasse / IP: 67
 LED / stk. pr. meter: 96
 Lys spredning / grader: 120

Dæmpbar: Ja
 (Dæmper skal tilkøbes)

Klippemærke afstand / mm: 63
 Båndbredde / mm: 12
 Båndlængde / m. pr. rulle: 5
 Ledning i begge ender: 3 meter 5 x 0,4 mm²

Levetid / timer: 50.000



Foto:



RoHS

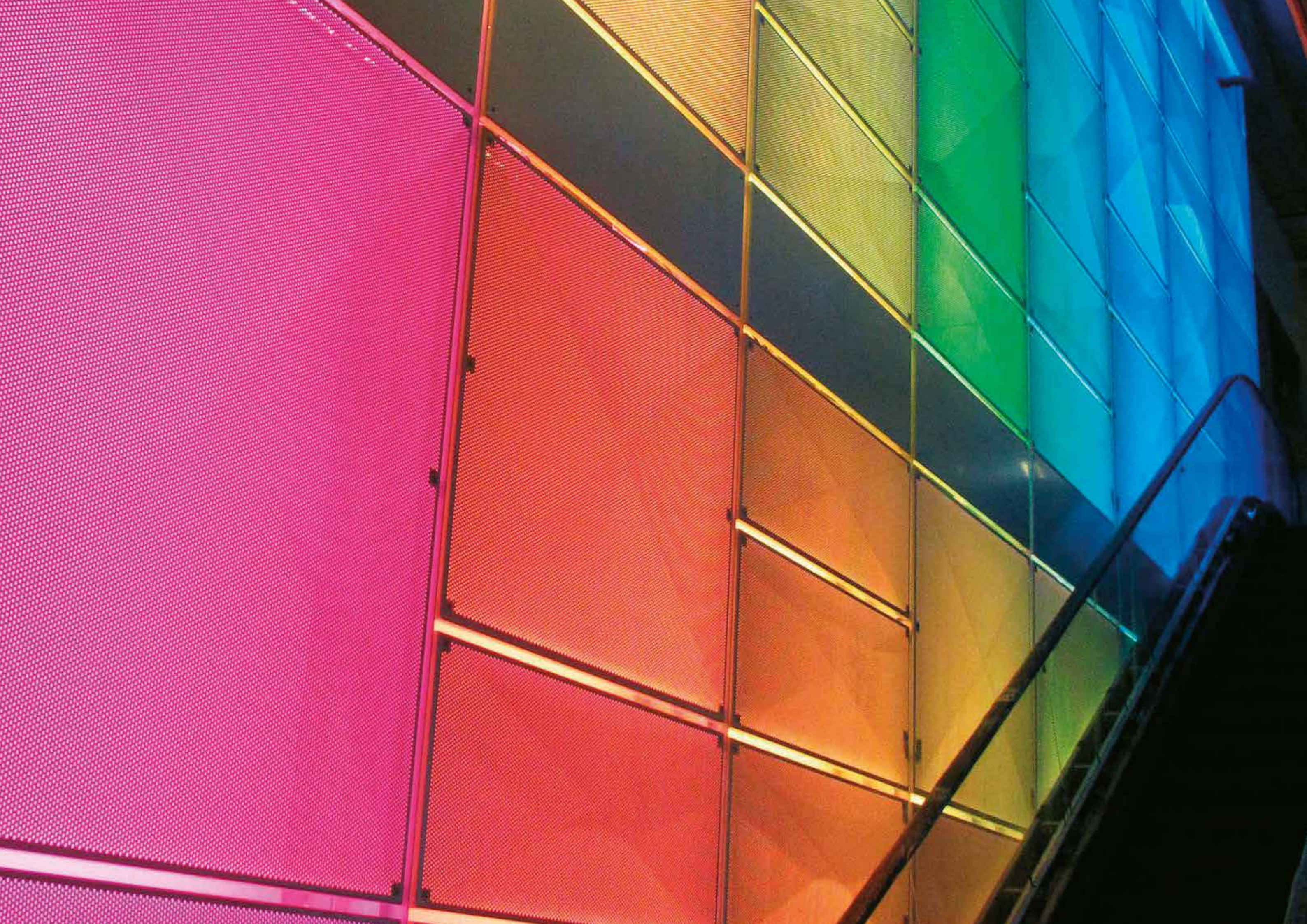

24VDC LED PS 6W

SNAPPY STRØMFORSYNING / POWER SUPPLY

LED

Varenr. / Item no.:	VN600240
Udgangsspænding / Output Voltage:	24VDC
Udgangseffekt / Output Power:	6W
Udgangsstrøm / Output Current:	0,25A
Indgangsspænding / Input Voltage:	200-240VAC
Input frekvens / Input Frequency:	50Hz
Omgivelsestemp. / Working Temp.:	-20°C ~ 45°C
Arbejdsfugtighed / Working Humidity:	45% ~ 85%
Tætningklasse / IP Protection Class:	IP20
Beskyttelsesklasse / Appliance Class:	Class II
Levetid - timer / Life Cycle - Hours:	30.000
Dimensioner L x B x H / Dimensions L x W x H:	98,4 x 45,6 x 10,7 mm



RoHS



Dimensioner / Dimensions:



Foto / Photo:



24VDC LED PS 12W

SNAPPY STRØMFORSYNING / POWER SUPPLY

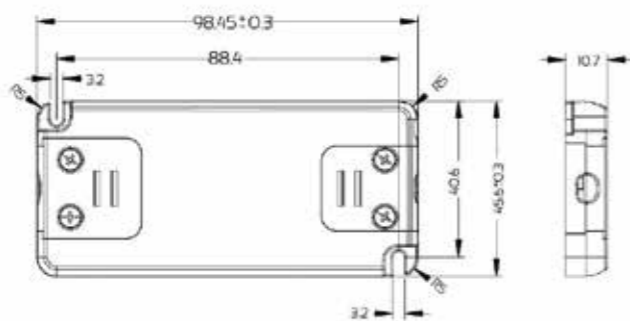
LED

Varenr. / Item no.:	VN600241
Udgangsspænding / Output Voltage:	24VDC
Udgangseffekt / Output Power:	12W
Udgangsstrøm / Output Current:	0,5A
Indgangsspænding / Input Voltage:	200-240VAC
Input frekvens / Input Frequency:	50Hz
Omgivelsestemp. / Working Temp.:	-20°C ~ 45°C
Arbejdsfugtighed / Working Humidity:	45% ~ 85%
Tætningklasse / IP Protection Class:	IP20
Beskyttelsesklasse / Appliance Class:	Class II
Levetid - timer / Life Cycle - Hours:	30.000
Dimensioner L x B x H / Dimensions L x W x H:	127,3 x 49,8 x 10,7 mm



RoHS



Dimensioner / Dimensions:



Foto / Photo:



24VDC LED PS 15W

SNAPPY STRØMFORSYNING / POWER SUPPLY

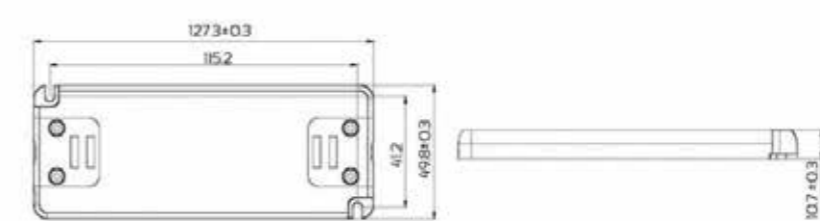
LED

Varenr. / Item no.:	VN600220
Udgangsspænding / Output Voltage:	24VDC
Udgangseffekt / Output Power:	15W
Udgangsstrøm / Output Current:	0,62A
Indgangsspænding / Input Voltage:	200-240VAC
Input frekvens / Input Frequency:	50Hz
Omgivelsestemp. / Working Temp.:	-20°C ~ 45°C
Arbejdsfugtighed / Working Humidity:	45% ~ 85%
Tætningklasse / IP Protection Class:	IP20
Beskyttelsesklasse / Appliance Class:	Class II
Levetid - timer / Life Cycle - Hours:	30.000
Dimensioner L x B x H / Dimensions L x W x H:	128,4 x 50,6 x 13,5 mm



RoHS



Dimensioner / Dimensions:



Foto / Photo:
Photo



24VDC LED PS 20W

SNAPPY STRØMFORSYNING / POWER SUPPLY

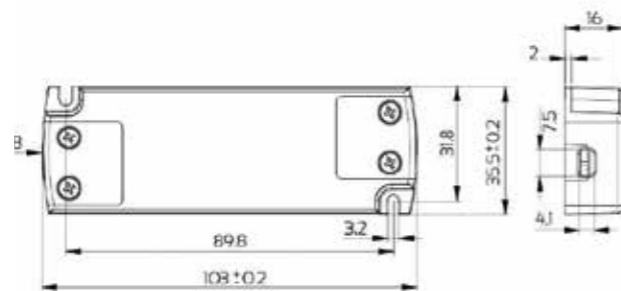
LED

Varenr. / Item no.:	VN600200
Udgangsspænding / Output Voltage:	24VDC
Udgangseffekt / Output Power:	20W
Udgangsstrøm / Output Current:	0,84A
Indgangsspænding / Input Voltage:	200-240VAC
Input frekvens / Input Frequency:	50Hz
Omgivelsestemp. / Working Temp.:	-20°C ~ 45°C
Arbejdsfugtighed / Working Humidity:	45% ~ 85%
Tætningklasse / IP Protection Class:	IP20
Beskyttelsesklasse / Appliance Class:	Class II
Levetid - timer / Life Cycle - Hours:	30.000
Dimensioner L x B x H / Dimensions L x W x H:	103 x 35 x 16 mm



RoHS



Dimensioner / Dimensions:



Foto / Photo:



24VDC LED PS 30W

SNAPPY STRØMFORSYNING / POWER SUPPLY

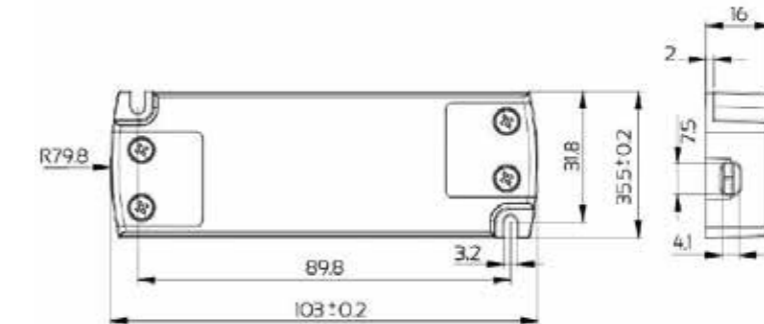
LED

Varenr. / Item no.:	VN600201
Udgangsspænding / Output Voltage:	24VDC
Udgangseffekt / Output Power:	30W
Udgangsstrøm / Output Current:	1,25A
Indgangsspænding / Input Voltage:	200-240VAC
Input frekvens / Input Frequency:	50Hz
Omgivelsestemp. / Working Temp.:	-20°C ~ 45°C
Arbejdsfugtighed / Working Humidity:	45% ~ 85%
Tætningklasse / IP Protection Class:	IP20
Beskyttelsesklasse / Appliance Class:	Class II
Levetid - timer / Life Cycle - Hours:	30.000
Dimensioner L x B x H / Dimensions L x W x H:	159,9 x 57,8 x 18 mm



RoHS



Dimensioner / Dimensions:



Foto / Photo:



24VDC LED PS 50W

SNAPPY STRØMFORSYNING / POWER SUPPLY

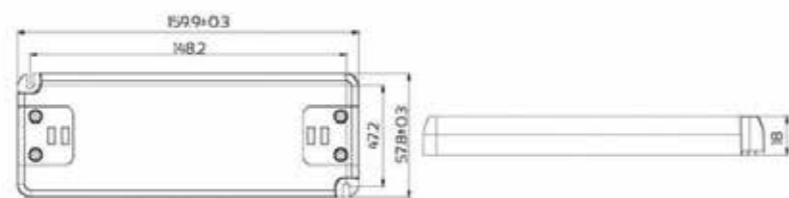
LED

Varenr. / Item no.:	VN600244
Udgangsspænding / Output Voltage:	24VDC
Udgangseffekt / Output Power:	50W
Udgangsstrøm / Output Current:	2,08A
Indgangsspænding / Input Voltage:	200-240VAC
Input frekvens / Input Frequency:	50Hz
Omgivelsestemp. / Working Temp.:	-20°C ~ 45°C
Arbejdsfugtighed / Working Humidity:	45% ~ 85%
Tætningklasse / IP Protection Class:	IP20
Beskyttelsesklasse / Appliance Class:	Class II
Levetid - timer / Life Cycle - Hours:	30.000
Dimensioner L x B x H / Dimensions L x W x H:	185 x 63,5 x 22 mm



RoHS



Dimensioner / Dimensions:



Foto / Photo:
Photo



24VDC LED PS 75W

SNAPPY STRØMFORSYNING / POWER SUPPLY

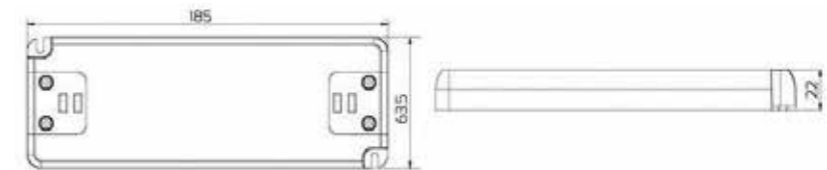
LED

Varenr. / Item no.:	VN600245
Udgangsspænding / Output Voltage:	24VDC
Udgangseffekt / Output Power:	75W
Udgangsstrøm / Output Current:	3,12A
Indgangsspænding / Input Voltage:	200-240VAC
Input frekvens / Input Frequency:	50Hz
Omgivelsestemp. / Working Temp.:	-20°C ~ 45°C
Arbejdsfugtighed / Working Humidity:	45% ~ 85%
Tætningklasse / IP Protection Class:	IP20
Beskyttelsesklasse / Appliance Class:	Class II
Levetid - timer / Life Cycle - Hours:	30.000
Dimensioner L x B x H / Dimensions L x W x H:	170 x 45 x 29 mm



RoHS



Dimensioner / Dimensions:



Foto / Photo:



24VDC LED PS 150W

SNAPPY STRØMFORSYNING / POWER SUPPLY

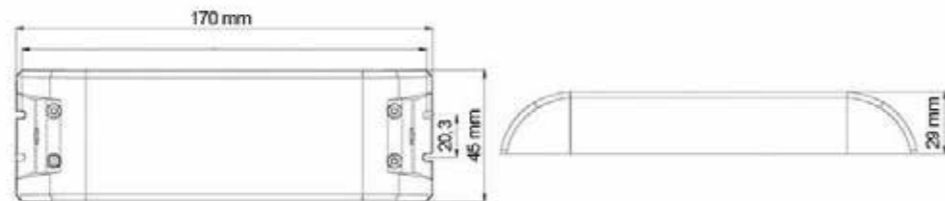
LED

Varenr. / Item no.:	VN600286
Udgangsspænding / Output Voltage:	24VDC
Udgangseffekt / Output Power:	150W
Udgangsstrøm / Output Current:	6,25A
Indgangsspænding / Input Voltage:	200-240VAC
Input frekvens / Input Frequency:	50/60Hz
Omgivelsestemp. / Working Temp.:	-20°C ~ 45°C
Arbejdsfugtighed / Working Humidity:	45% ~ 85%
Tætningklasse / IP Protection Class:	IP20
Beskyttelsesklasse / Appliance Class:	Class II
Levetid - timer / Life Cycle - Hours:	30.000
Dimensioner L x B x H / Dimensions L x W x H:	180 x 66 x 32 mm



RoHS



Dimensioner / Dimensions:



Foto / Photo:



24VDC LED PS 250W

SNAPPY STRØMFORSYNING / POWER SUPPLY

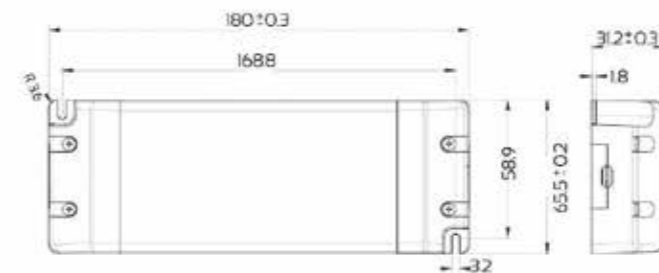
LED

Varenr. / Item no.:	VN600270
Udgangsspænding / Output Voltage:	24VDC
Udgangseffekt / Output Power:	250W
Udgangsstrøm / Output Current:	10,4A
Indgangsspænding / Input Voltage:	200-240VAC
Input frekvens / Input Frequency:	50Hz
Omgivelsestemp. / Working Temp.:	-20°C ~ 45°C
Arbejdsfugtighed / Working Humidity:	45% ~ 85%
Tætningklasse / IP Protection Class:	IP20
Beskyttelsesklasse / Appliance Class:	Class II
Levetid - timer / Life Cycle - Hours:	30.000
Dimensioner L x B x H / Dimensions L x W x H:	195 x 68 x 32 mm



RoHS



Dimensioner / Dimensions:



Foto / Photo:



24VDC LED PS 320W

SNAPPY STRØMFORSYNING / POWER SUPPLY

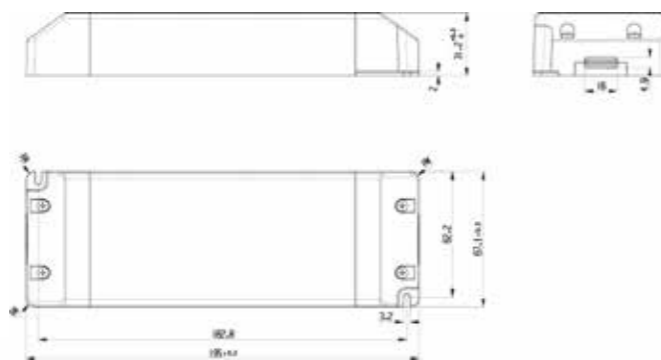
LED

Varenr. / Item no.:	VN600271
Udgangsspænding / Output Voltage:	24VDC
Udgangseffekt / Output Power:	320W
Udgangsstrøm / Output Current:	13,3A
Indgangsspænding / Input Voltage:	200-240VAC
Input frekvens / Input Frequency:	50Hz
Omgivelsestemp. / Working Temp.:	-20°C ~ 45°C
Arbejdsfugtighed / Working Humidity:	45% ~ 85%
Tætningklasse / IP Protection Class:	IP20
Beskyttelsesklasse / Appliance Class:	Class II
Levetid - timer / Life Cycle - Hours:	30.000
Dimensioner L x B x H / Dimensions L x W x H:	215 x 77,5 x 35 mm



RoHS



Dimensioner / Dimensions:



Foto / Photo:



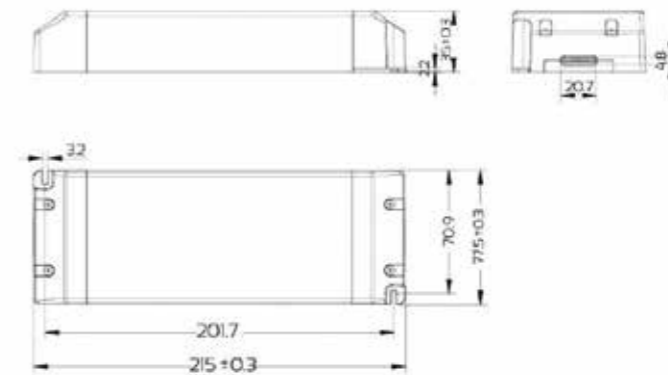

24VDC LED PS 60W · LONG

SNAPPY STRØMFORSYNING / POWER SUPPLY

LED

Varenr. / Item no.:	VN600246
Udgangsspænding / Output Voltage:	24VDC
Udgangseffekt / Output Power:	60W
Udgangsstrøm / Output Current:	2,5A
Indgangsspænding / Input Voltage:	200-240VAC
Input frekvens / Input Frequency:	50Hz
Omgivelsestemp. / Working Temp.:	-20°C ~ 45°C
Arbejdsfugtighed / Working Humidity:	45% ~ 85%
Tætningklasse / IP Protection Class:	IP20
Beskyttelsesklasse / Appliance Class:	Class II
Levetid - timer / Life Cycle - Hours:	30.000
Dimensioner L x B x H / Dimensions L x W x H:	356 x 31 x 23 mm



RoHS



Dimensioner / Dimensions:



Foto / Photo: Photo



24VDC LED PS 150W · LONG

SNAPPY STRØMFORSYNING / POWER SUPPLY

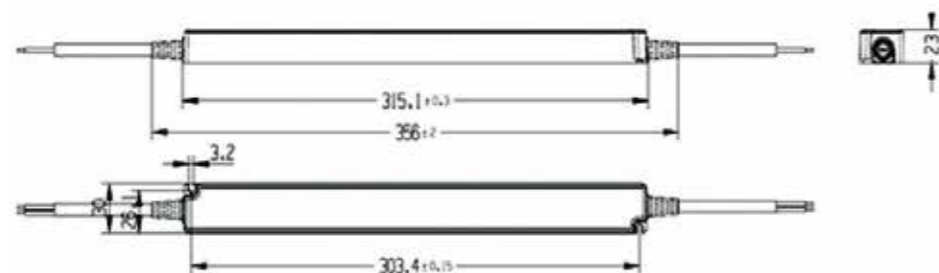
LED

Varenr. / Item no.:	VN600264
Udgangsspænding / Output Voltage:	24VDC
Udgangseffekt / Output Power:	150W
Udgangsstrøm / Output Current:	6,25A
Indgangsspænding / Input Voltage:	200-240VAC
Input frekvens / Input Frequency:	50Hz
Omgivelsestemp. / Working Temp.:	-20°C ~ 45°C
Arbejdsfugtighed / Working Humidity:	45% ~ 85%
Tætningklasse / IP Protection Class:	IP20
Beskyttelsesklasse / Appliance Class:	Class II
Levetid - timer / Life Cycle - Hours:	30.000
Dimensioner L x B x H / Dimensions L x W x H:	322,6 x 30,1 x 21,5 mm



RoHS



Dimensioner / Dimensions:



Foto / Photo:



24VDC LED PS 200W · LONG

SNAPPY STRØMFORSYNING / POWER SUPPLY

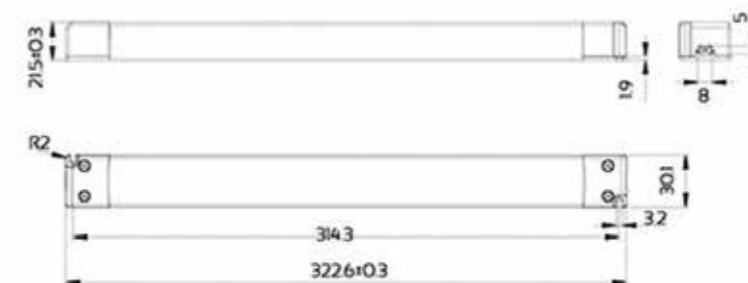
LED

Varenr. / Item no.:	VN600281
Udgangsspænding / Output Voltage:	24VDC
Udgangseffekt / Output Power:	200W
Udgangsstrøm / Output Current:	8,33A
Indgangsspænding / Input Voltage:	200-240VAC
Input frekvens / Input Frequency:	50Hz
Omgivelsestemp. / Working Temp.:	-20°C ~ 45°C
Arbejdsfugtighed / Working Humidity:	45% ~ 85%
Tætningklasse / IP Protection Class:	IP20
Beskyttelsesklasse / Appliance Class:	Class II
Levetid - timer / Life Cycle - Hours:	30.000
Dimensioner L x B x H / Dimensions L x W x H:	357 x 32 x 23 mm



RoHS



Dimensioner / Dimensions:



Foto / Photo:

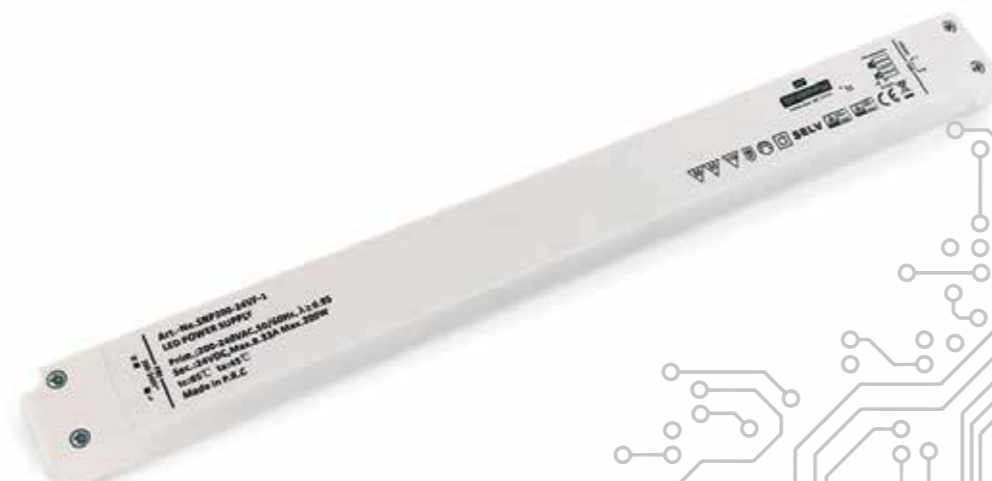

24VDC LED PS 240W · LONG

SNAPPY STRØMFORSYNING / POWER SUPPLY

LED

Varenr. / Item no.:	VN600282
Udgangsspænding / Output Voltage:	24VDC
Udgangseffekt / Output Power:	240W
Udgangsstrøm / Output Current:	10A
Indgangsspænding / Input Voltage:	200-240VAC
Input frekvens / Input Frequency:	50Hz
Omgivelsestemp. / Working Temp.:	-20°C ~ 45°C
Arbejdsfugtighed / Working Humidity:	45% ~ 85%
Tætningklasse / IP Protection Class:	IP20
Beskyttelsesklasse / Appliance Class:	Class II
Levetid - timer / Life Cycle - Hours:	30.000
Dimensioner L x B x H / Dimensions L x W x H:	357 x 32 x 23 mm



RoHS



Dimensioner / Dimensions:



Foto / Photo:



24VDC LED PS 60W · LONG

SNAPPY STRØMFORSYNING / POWER SUPPLY

LED

Varenr. / Item no.:	VN600267
Udgangsspænding / Output Voltage:	24VDC
Udgangseffekt / Output Power:	60W
Udgangsstrøm / Output Current:	2,5A
Indgangsspænding / Input Voltage:	200-240VAC
Input frekvens / Input Frequency:	50Hz
Omgivelsestemp. / Working Temp.:	-20°C ~ 45°C
Arbejdsfugtighed / Working Humidity:	45% ~ 85%
Tætningklasse / IP Protection Class:	IP66
Beskyttelsesklasse / Appliance Class:	Class II
Levetid - timer / Life Cycle - Hours:	30.000
Dimensioner L x B x H / Dimensions L x W x H:	356 x 31 x 23 mm



RoHS



Dimensioner / Dimensions:



Foto / Photo: Photo



24VDC LED PS 150W · LONG

SNAPPY STRØMFORSYNING / POWER SUPPLY

LED

Varenr. / Item no.:	VN600269
Udgangsspænding / Output Voltage:	24VDC
Udgangseffekt / Output Power:	150W
Udgangsstrøm / Output Current:	6,25A
Indgangsspænding / Input Voltage:	200-240VAC
Input frekvens / Input Frequency:	50Hz
Omgivelsestemp. / Working Temp.:	-20°C ~ 45°C
Arbejdsfugtighed / Working Humidity:	45% ~ 85%
Tætningklasse / IP Protection Class:	IP66
Beskyttelsesklasse / Appliance Class:	Class II
Levetid - timer / Life Cycle - Hours:	30.000
Dimensioner L x B x H / Dimensions L x W x H:	356 x 30 x 23 mm



RoHS



Dimensioner / Dimensions:



Foto / Photo:



24VDC LED PS 200W · LOW HEIGHT

SNAPPY STRØMFORSYNING / POWER SUPPLY

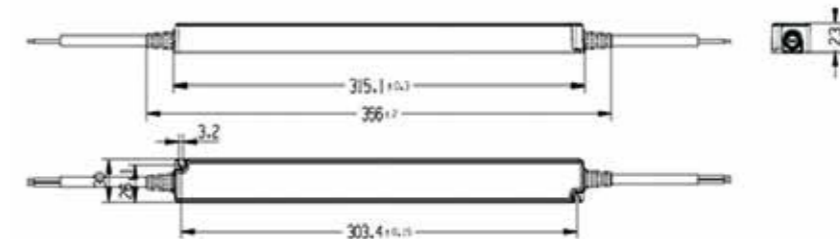
LED

Varenr. / Item no.:	VN600284
Udgangsspænding / Output Voltage:	24VDC
Udgangseffekt / Output Power:	200W
Udgangsstrøm / Output Current:	8,3A
Indgangsspænding / Input Voltage:	180 ~ 305VAC
Input frekvens / Input Frequency:	50Hz
Omgivelsestemp. / Working Temp.:	-40°C ~ 60°C
Arbejdsfugtighed / Working Humidity:	15% ~ 95%
Tætningklasse / IP Protection Class:	IP67
Beskyttelsesklasse / Appliance Class:	Class I
Levetid - timer / Life Cycle - Hours:	50.000
Dimensioner L x B x H / Dimensions L x W x H:	247 x 66,5 x 20,7 mm



RoHS

Dimensioner / Dimensions:



Foto / Photo:



24VDC LED PS 320W · LOW HEIGHT

SNAPPY STRØMFORSYNING / POWER SUPPLY

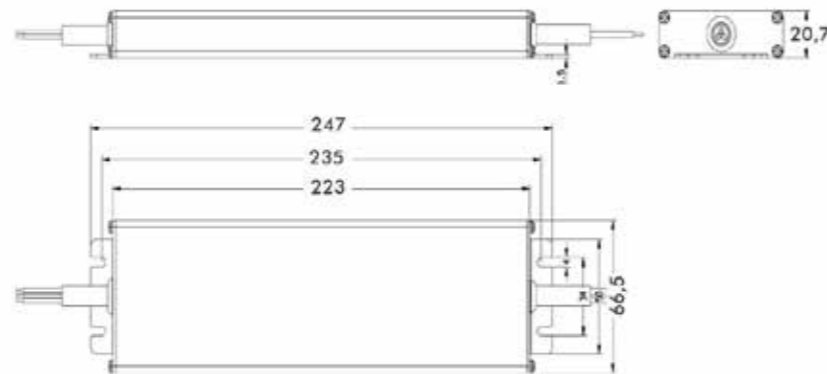
LED

Varenr. / Item no.:	VN600285
Udgangsspænding / Output Voltage:	24VDC
Udgangseffekt / Output Power:	320W
Udgangsstrøm / Output Current:	13,3A
Indgangsspænding / Input Voltage:	180 ~ 305VAC
Input frekvens / Input Frequency:	50Hz
Omgivelsestemp. / Working Temp.:	-40°C ~ 60°C
Arbejdsfugtighed / Working Humidity:	15% ~ 95%
Tætningklasse / IP Protection Class:	IP67
Beskyttelsesklasse / Appliance Class:	Class I
Levetid - timer / Life Cycle - Hours:	50.000
Dimensioner L x B x H / Dimensions L x W x H:	285 x 86,3 x 22,4 mm



RoHS

Dimensioner / Dimensions:



Foto / Photo:



24VDC LED PS 75W

MEAN WELL STRØMFORSYNING / POWER SUPPLY

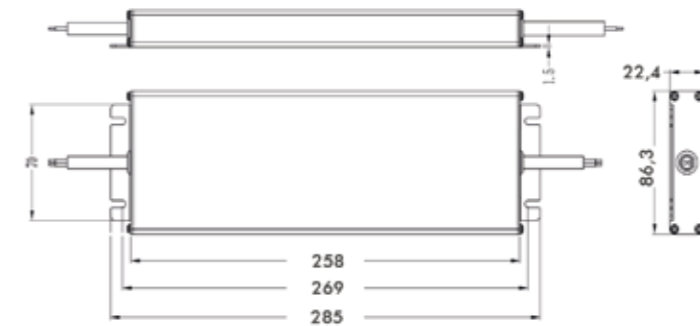
LED

Varenr. / Item no.:	VN600253
Udgangsspænding / Output Voltage:	24VDC
Udgangseffekt / Output Power:	75W
Udgangsstrøm / Output Current:	3,15A
Indgangsspænding / Input Voltage:	100 ~ 305VAC
Input frekvens / Input Frequency:	47 ~ 63Hz
Omgivelsestemp. / Working Temp.:	-40°C ~ 85°C
Arbejdsfugtighed / Working Humidity:	20% ~ 95%
Tætningklasse / IP Protection Class:	IP67
Beskyttelsesklasse / Appliance Class:	Class I
Levetid - timer / Life Cycle - Hours:	50.000
Dimensioner L x B x H / Dimensions L x W x H:	180 x 63 x 35,5 mm



Dimensioner / Dimensions:



Foto / Photo:



24VDC LED PS 150W

MEAN WELL STRØMFORSYNING / POWER SUPPLY

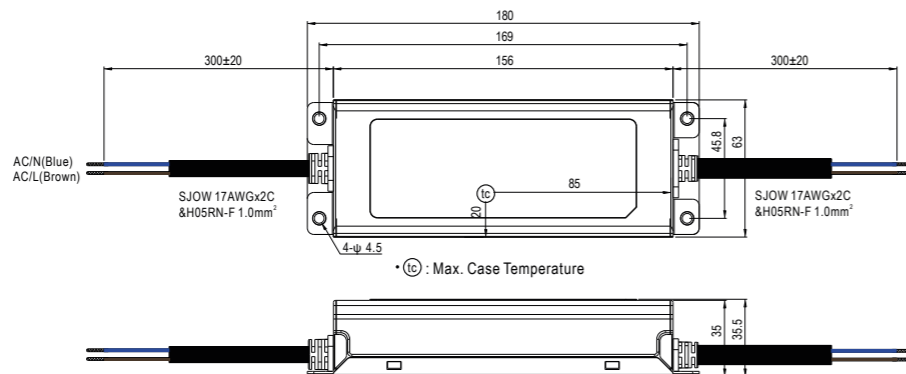
LED

Varenr. / Item no.:	VN600210
Udgangsspænding / Output Voltage:	24VDC
Udgangseffekt / Output Power:	150W
Udgangsstrøm / Output Current:	6,25A
Indgangsspænding / Input Voltage:	100 ~ 305VAC
Input frekvens / Input Frequency:	47 ~ 63Hz
Omgivelsestemp. / Working Temp.:	-40°C ~ 90°C
Arbejdsfugtighed / Working Humidity:	20% ~ 95%
Tætningklasse / IP Protection Class:	IP67
Beskyttelsesklasse / Appliance Class:	Class I
Levetid - timer / Life Cycle - Hours:	50.000
Dimensioner L x B x H / Dimensions L x W x H:	219 x 63 x 35,5 mm



Dimensioner / Dimensions:



Foto / Photo:



24VDC LED PS 200W

MEAN WELL STRØMFORSYNING / POWER SUPPLY

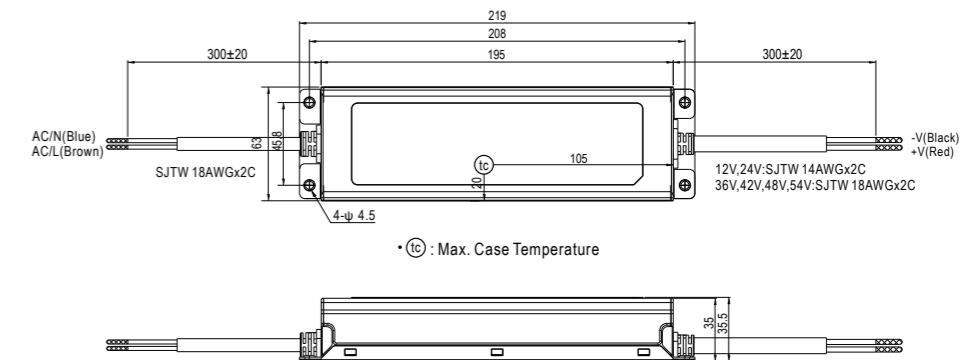
LED

Varenr. / Item no.:	VN600212
Udgangsspænding / Output Voltage:	24VDC
Udgangseffekt / Output Power:	200W
Udgangsstrøm / Output Current:	8,4A
Indgangsspænding / Input Voltage:	100 ~ 305VAC
Input frekvens / Input Frequency:	47 ~ 63Hz
Omgivelsestemp. / Working Temp.:	-40°C ~ 90°C
Arbejdsfugtighed / Working Humidity:	20% ~ 95%
Tætningklasse / IP Protection Class:	IP67
Beskyttelsesklasse / Appliance Class:	Class I
Levetid - timer / Life Cycle - Hours:	50.000
Dimensioner L x B x H / Dimensions L x W x H:	244 x 71 x 37,5 mm



Dimensioner / Dimensions:



Foto / Photo:



24VDC LED PS 320W

MEAN WELL STRØMFORSYNING / POWER SUPPLY

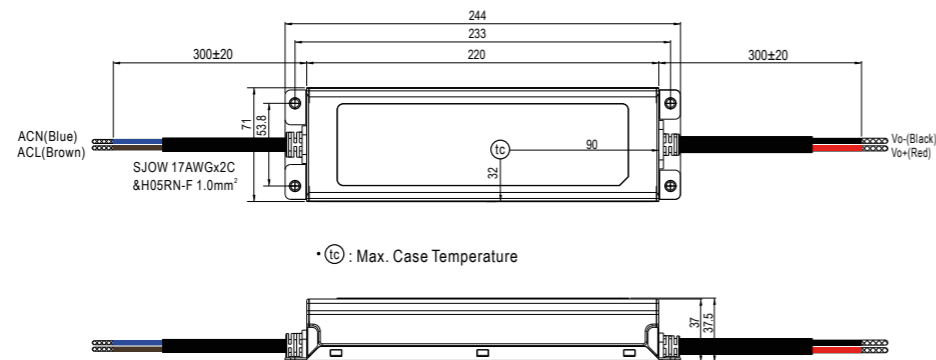
LED

Varenr. / Item no.:	VN600217
Udgangsspænding / Output Voltage:	24VDC
Udgangseffekt / Output Power:	320W
Udgangsstrøm / Output Current:	13,3A
Indgangsspænding / Input Voltage:	90 ~ 305VAC
Input frekvens / Input Frequency:	47 ~ 63Hz
Omgivelsestemp. / Working Temp.:	-40°C ~ 70°C
Arbejdsfugtighed / Working Humidity:	20% ~ 95%
Tætningklasse / IP Protection Class:	IP67
Beskyttelsesklasse / Appliance Class:	Class I
Levetid - timer / Life Cycle - Hours:	60.000
Dimensioner L x B x H / Dimensions L x W x H:	252 x 90 x 43,8 mm



Dimensioner / Dimensions:



Foto / Photo:



24VDC LED PS 75W · DALI

MEAN WELL STRØMFORSYNING / POWER SUPPLY

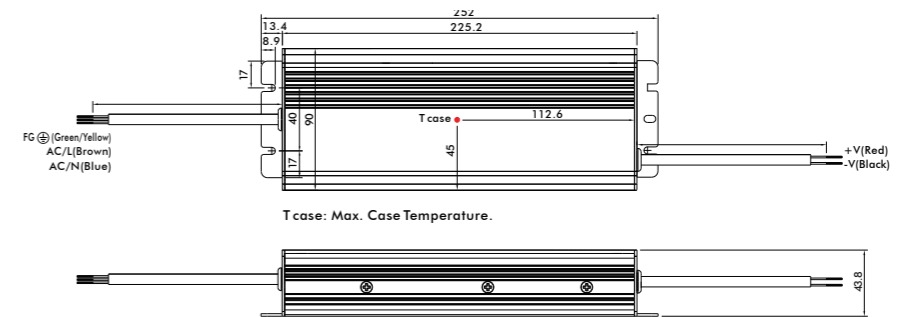
Varenr. / Item no.:	VN600279
Udgangsspænding / Output Voltage:	24VDC
Udgangseffekt / Output Power:	75W
Udgangsstrøm / Output Current:	3,15A
Indgangsspænding / Input Voltage:	100 ~ 305VAC
Dæmp / Dimming Mode:	DALI
Input frekvens / Input Frequency:	47 ~ 63Hz
Omgivelsestemp. / Working Temp.:	-40°C ~ 85°C
Arbejdsfugtighed / Working Humidity:	20% ~ 95%
Tætningklasse / IP Protection Class:	IP67
Beskyttelsesklasse / Appliance Class:	Class I
Levetid - timer / Life Cycle - Hours:	50.000
Dimensioner L x B x H / Dimensions L x W x H:	180 x 63 x 35,5 mm



Dimensioner / Dimensions:



Foto / Photo:



24VDC LED PS 150W · DALI

MEAN WELL STRØMFORSYNING / POWER SUPPLY

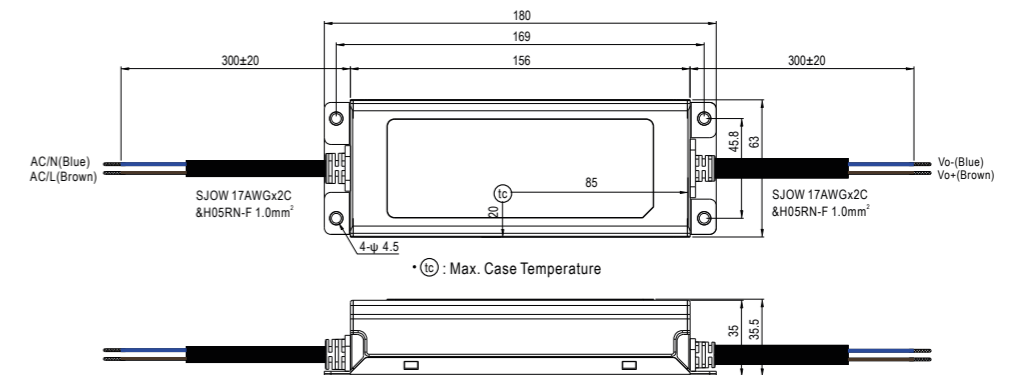
Varenr. / Item no.:	VN600250
Udgangsspænding / Output Voltage:	24VDC
Udgangseffekt / Output Power:	150W
Udgangsstrøm / Output Current:	6,25A
Indgangsspænding / Input Voltage:	100 ~ 305VAC
Dæmp / Dimming Mode:	DALI
Input frekvens / Input Frequency:	47 ~ 63Hz
Omgivelsestemp. / Working Temp.:	-40°C ~ 90°C
Arbejdsfugtighed / Working Humidity:	20% ~ 95%
Tætningklasse / IP Protection Class:	IP67
Beskyttelsesklasse / Appliance Class:	Class I
Levetid - timer / Life Cycle - Hours:	60.000
Dimensioner L x B x H / Dimensions L x W x H:	219 x 63 x 35,5 mm

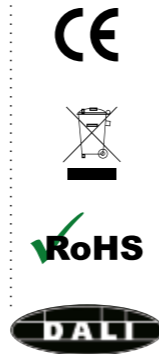

Dimensioner / Dimensions:



Foto / Photo:



24VDC LED PS 200W · DALI

MEAN WELL STRØMFORSYNING / POWER SUPPLY

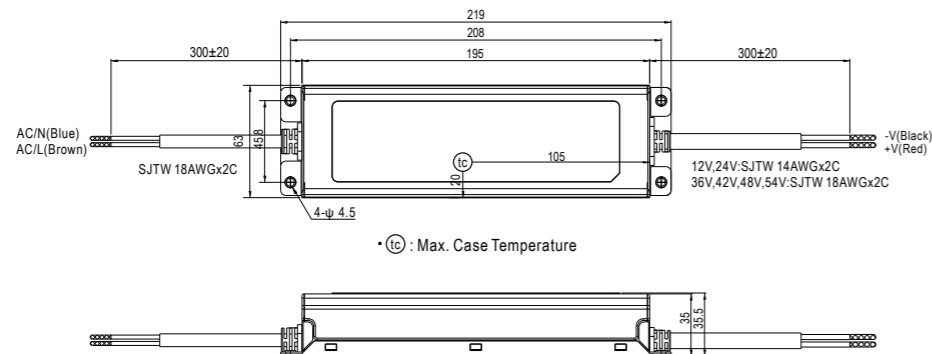
Varenr. / Item no.:	VN600259
Udgangsspænding / Output Voltage:	24VDC
Udgangseffekt / Output Power:	200W
Udgangsstrøm / Output Current:	8,4A
Indgangsspænding / Input Voltage:	100 ~ 305VAC
Dæmp / Dimming Mode:	DALI
Input frekvens / Input Frequency:	477 ~ 63Hz
Omgivelsestemp. / Working Temp.:	-40°C ~ 90°C
Arbejdsfugtighed / Working Humidity:	20% ~ 95%
Tætningklasse / IP Protection Class:	IP67
Beskyttelsesklasse / Appliance Class:	Class I
Levetid - timer / Life Cycle - Hours:	50.000
Dimensioner L x B x H / Dimensions L x W x H:	244 x 71 x 37,5 mm

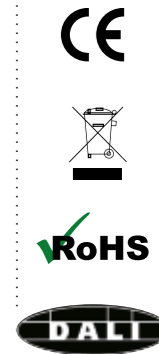

Dimensioner / Dimensions:



Foto / Photo:



24VDC LED PS 60W · DIN

MEAN WELL STRØMFORSYNING / POWER SUPPLY

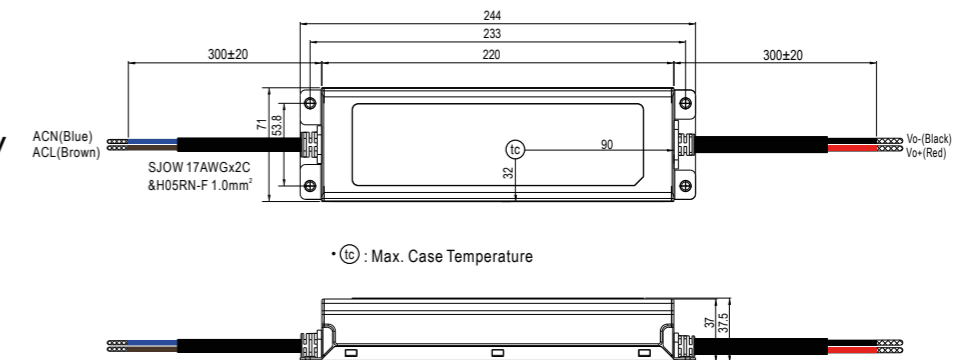

Varenr. / Item no.:	VN600292
Udgangsspænding / Output Voltage:	24VDC
Udgangseffekt / Output Power:	60W
Udgangsstrøm / Output Current:	2,5A
Indgangsspænding / Input Voltage:	100 ~ 305VAC
Input frekvens / Input Frequency:	47 ~ 63Hz
Omgivelsestemp. / Working Temp.:	-30°C ~ 70°C
Arbejdsfugtighed / Working Humidity:	20% ~ 90%
Tætningklasse / IP Protection Class:	IP20
Beskyttelsesklasse / Appliance Class:	Class II
Levetid - timer / Life Cycle - Hours:	30.000
Dimensioner L x B x H / Dimensions L x W x H:	52,5 x 90 x 54,5 mm



RoHS



Dimensioner / Dimensions:



Passer til:



Foto / Photo:



24VDC LED PS 100W · DIN

MEAN WELL STRØMFORSYNING / POWER SUPPLY



Varenr. / Item no.:	VN600291
Udgangsspænding / Output Voltage:	24VDC
Udgangseffekt / Output Power:	100W
Udgangsstrøm / Output Current:	3,83A
Indgangsspænding / Input Voltage:	100 ~ 305VAC
Input frekvens / Input Frequency:	47 ~ 63Hz
Omgivelsestemp. / Working Temp.:	-30°C ~ 70°C
Arbejdsfugtighed / Working Humidity:	20% ~ 90%
Tætningklasse / IP Protection Class:	IP20
Beskyttelsesklasse / Appliance Class:	Class II
Levetid - timer / Life Cycle - Hours:	30.000
Dimensioner L x B x H / Dimensions L x W x H:	70 x 90 x 58,4 mm



RoHS



Dimensioner / Dimensions:

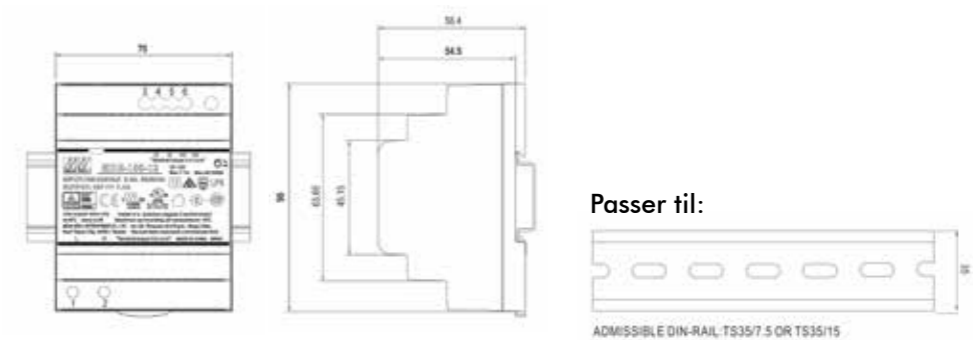

Passer til:



Foto / Photo:



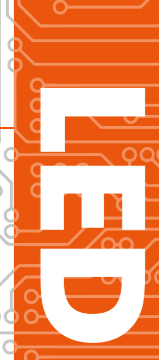

24VDC LED PS 50W · DIMMABLE

DÆMPBAR STRØMFORSYNING / DIMMABLE POWER SUPPLY



Varenr. / Item no.:	VN600280
Udgangsspænding / Output Voltage:	24VDC
Udgangseffekt / Output Power:	50W
Udgangsstrøm / Output Current:	2,08A
Indgangsspænding / Input Voltage:	200-240VAC
Dæmp / Dimming Mode:	Triac Dimming (Leading- and trailing edge)
Dæmpningsområde / Dimming Range:	20%-90%
Input frekvens / Input Frequency:	50Hz
Omgivelsestemp. / Working Temp.:	-20°C ~ 45°C
Arbejdsfugtighed / Working Humidity:	45% ~ 85%
Tætningklasse / IP Protection Class:	IP20
Beskyttelsesklasse / Appliance Class:	Class II
Levetid - timer / Life Cycle - Hours:	30.000
Dimensioner L x B x H / Dimensions L x W x H:	177 x 58 x 22 mm



RoHS



Dimensioner / Dimensions:



Foto / Photo:



24VDC LED PS 75W · DIMMABLE

DÆMPBAR STRØMFORSYNING / DIMMABLE POWER SUPPLY

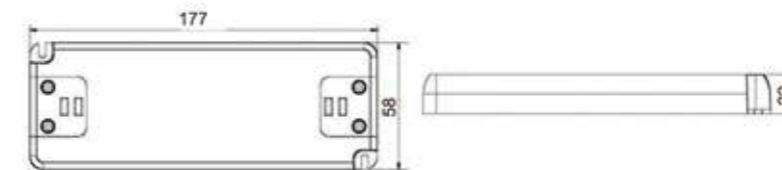
LED

Varenr. / Item no.:	VN600283
Udgangsspænding / Output Voltage:	24VDC
Udgangseffekt / Output Power:	75W
Udgangsstrøm / Output Current:	3,125A
Indgangsspænding / Input Voltage:	200-240VAC
Dæmp / Dimming Mode:	Triac Dimming (Leading- and trailing edge)
Dæmpningsområde / Dimming Range:	20%-90%
Input frekvens / Input Frequency:	50Hz
Omgivelsestemp. / Working Temp.:	-20°C ~ 45°C
Arbejdsfugtighed / Working Humidity:	45% ~ 85%
Tætningklasse / IP Protection Class:	IP20
Beskyttelsesklasse / Appliance Class:	Class II
Levetid - timer / Life Cycle - Hours:	30.000
Dimensioner L x B x H / Dimensions L x W x H:	171 x 57 x 32 mm



RoHS



DIMMABLE

Dimensioner / Dimensions:



Foto / Photo:



24VDC LED PS 80W · DIMMABLE

DÆMPBAR STRØMFORSYNING / DIMMABLE POWER SUPPLY

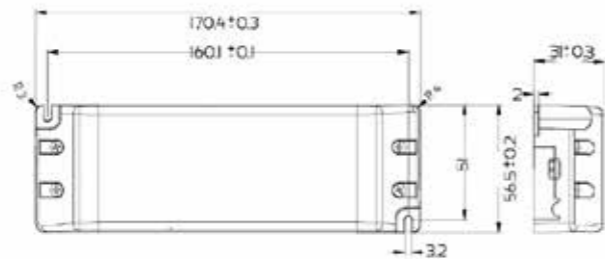
LED

Varenr. / Item no.:	VN600273
Udgangsspænding / Output Voltage:	24VDC
Udgangseffekt / Output Power:	80W
Udgangsstrøm / Output Current:	3,33A
Indgangsspænding / Input Voltage:	200-240VAC
Dæmp / Dimming Mode:	Triac Dimming (Leading- and trailing edge)
Dæmpningsområde / Dimming Range:	20%-90%
Input frekvens / Input Frequency:	50Hz
Omgivelsestemp. / Working Temp.:	-20°C ~ 45°C
Arbejdsfugtighed / Working Humidity:	40% ~ 85%
Tætningklasse / IP Protection Class:	IP66
Beskyttelsesklasse / Appliance Class:	Class II
Levetid - timer / Life Cycle - Hours:	30.000
Dimensioner L x B x H / Dimensions L x W x H:	230 x 70 x 46 mm



RoHS



DIMMABLE

Dimensioner / Dimensions:



Foto / Photo:



24VDC LED PS 150W · DIMMABLE

DÆMPBAR STRØMFORSYNING / DIMMABLE POWER SUPPLY

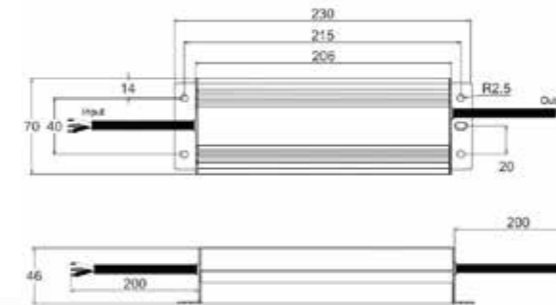
LED

Varenr. / Item no.:	VN600274
Udgangsspænding / Output Voltage:	24VDC
Udgangseffekt / Output Power:	150W
Udgangsstrøm / Output Current:	6,25A
Indgangsspænding / Input Voltage:	200-240VAC
Dæmp / Dimming Mode:	Triac Dimming (Leading- and trailing edge)
Dæmpningsområde / Dimming Range:	20%-90%
Input frekvens / Input Frequency:	50Hz
Omgivelsestemp. / Working Temp.:	-20°C ~ 45°C
Arbejdsfugtighed / Working Humidity:	40% ~ 85%
Tætningklasse / IP Protection Class:	IP66
Beskyttelsesklasse / Appliance Class:	Class II
Levetid - timer / Life Cycle - Hours:	30.000
Dimensioner L x B x H / Dimensions L x W x H:	256 x 78 x 47 mm



Dimensioner / Dimensions:



Foto / Photo:



24VDC LED PS 320W · DIMMABLE

DÆMPBAR STRØMFORSYNING / DIMMABLE POWER SUPPLY

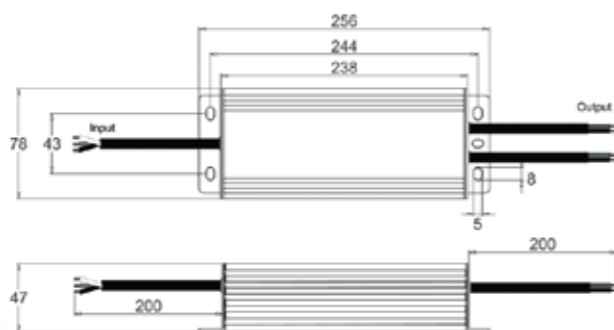
LED

Varenr. / Item no.:	VN600275
Udgangsspænding / Output Voltage:	24VDC
Udgangseffekt / Output Power:	320W
Udgangsstrøm / Output Current:	13,33A
Indgangsspænding / Input Voltage:	200-240VAC
Dæmp / Dimming Mode:	Triac Dimming (Leading- and trailing edge)
Dæmpningsområde / Dimming Range:	20%-90%
Input frekvens / Input Frequency:	50Hz
Omgivelsestemp. / Working Temp.:	-20°C ~ 45°C
Arbejdsfugtighed / Working Humidity:	40% ~ 85%
Tætningklasse / IP Protection Class:	IP66
Beskyttelsesklasse / Appliance Class:	Class II
Levetid - timer / Life Cycle - Hours:	30.000
Dimensioner L x B x H / Dimensions L x W x H:	276 x 78 x 47 mm



Dimensioner / Dimensions:



Foto / Photo:



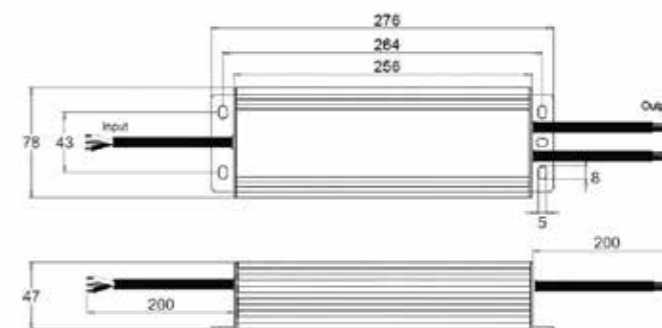

Kosttilskud

Kosttilskud

toos

2 PROFIL

ALU. PROFIL 2 / ALU. PROFILE 2



VARE NR. LM. NR. EAN NR. BESKRIVELSE
ITEM NO. LM. NO. EAN NO. DESCRIPTION

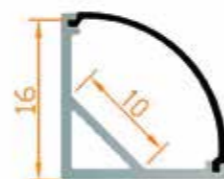

LM27102 7849000109 5713416001114 Alu. profil 2, m/opalcover - 2500 mm
LM27102 7849000109 5713416001114 Alu. profile 2, with opal cover - 2500 mm



LM27302 7849000112 5713416001121 Alu. profil 2, m/klar cover - 2500 mm
LM27302 7849000112 5713416001121 Alu. profile 2, with clear cover - 2500 mm



VN27102x1 7849000125 5713416001138 Alu. profil 2, endeprop m/hul for ledning
VN27102x1 7849000125 5713416001138 Alu. profile 2, end cap with hole for cable



VN27102x2 7849000138 5713416001145 Alu. profil 2, endeprop u/hul
VN27102x2 7849000138 5713416001145 Alu. profile 2, end cap without hole



VN27102x3 7849000028 5713416001152 Alu. profil 2, plastik clips til montage
VN27102x3 7849000028 5713416001152 Alu. profile 2, plastic clips for mounting



Hovedkomponenter:
Aluminium led profil er en anodiseret 6063-T5.
Opal matte omslag og klare omslag er PMMA.

Main components:
Aluminium led profile is an anodised 6063-T5.
Opal matte cover and clear cover is PMMA.

5 PROFIL

ALU. PROFIL 5 / ALU. PROFILE 5

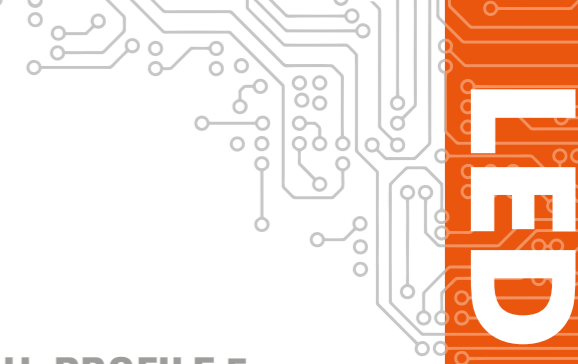

VARE NR. LM. NR. EAN NR. BESKRIVELSE
ITEM NO. LM. NO. EAN NO. DESCRIPTION



LM27105 7849990015 5713416001213 Alu. profil 5, m/opalcover - 2500 mm
LM27105 7849990015 5713416001213 Alu. profile 5, with opal cover - 2500 mm



LM27305 7849990028 5713416001220 Alu. profil 5, m/klar cover - 2500 mm
LM27305 7849990028 5713416001220 Alu. profile 5, with clear cover - 2500 mm



VN27105x1 7849990031 5713416001237 Alu. profil 5, endeprop m/hul for ledning
VN27105x1 7849990031 5713416001237 Alu. profile 5, end cap with hole for cable



VN27105x2 7849990044 5713416001244 Alu. profil 5, endeprop u/hul
VN27105x2 7849990044 5713416001244 Alu. profile 5, end cap without hole



VN27105x3 7849990206 5713416002203 Alu. profil 5, metal clips til montage
VN27105x3 7849990206 5713416002203 Alu. profile 5, metal clips for mounting



Hovedkomponenter:
Aluminium led profil er en anodiseret 6063-T5.
Opal matte omslag og klare omslag er PMMA.

Main components:
Aluminium led profile is an anodised 6063-T5.
Opal matte cover and clear cover is PMMA.

7 PROFIL

ALU. PROFIL 7 / ALU. PROFILE 7

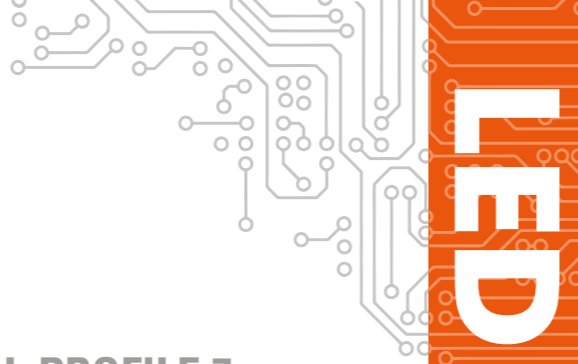

VARE NR. LM. NR. EAN NR. BESKRIVELSE
ITEM NO. LM. NO. EAN NO. DESCRIPTION

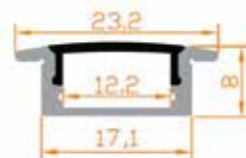

LM27107 7849000248 5713416001251 Alu. profil 7, m/opalcover - 2500 mm
LM27107 7849000248 5713416001251 Alu. profile 7, with opal cover - 2500 mm



LM27307 7849000251 5713416001268 Alu. profil 7, m/klar cover - 2500 mm
LM27307 7849000251 5713416001268 Alu. profile 7, with clear cover - 2500 mm



VN27107x1 7849000141 5713416001275 Alu. profil 7, endprop m/hul for ledning
VN27107x1 7849000141 5713416001275 Alu. profile 7, end cap with hole for cable



VN27107x2 7849000154 5713416001282 Alu. profil 7, endprop u/hul
VN27107x2 7849000154 5713416001282 Alu. profile 7, end cap without hole



VN27107x3 7849000167 5713416001299 Alu. profil 7, plastik clips til montage
VN27107x3 7849000167 5713416001299 Alu. profile 7, plastic clips for mounting



Hovedkomponenter:
Aluminium led profil er en anodiseret 6063-T5.
Opal matte omslag og klare omslag er PMMA.

Main components:
Aluminium led profile is an anodised 6063-T5.
Opal matte cover and clear cover is PMMA.

8 PROFIL

ALU. PROFIL 8 / ALU. PROFILE 8

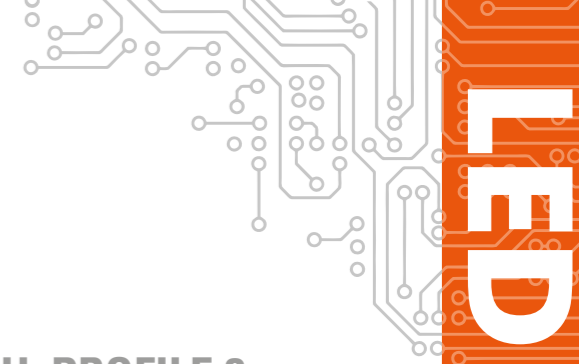

VARE NR. LM. NR. EAN NR. BESKRIVELSE
ITEM NO. LM. NO. EAN NO. DESCRIPTION

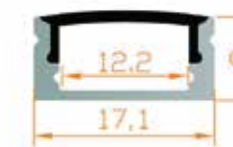

LM27108 7849000264 5713416001305 Alu. profil 8, m/opalcover - 2500 mm
LM27108 7849000264 5713416001305 Alu. profile 8, with opal cover - 2500 mm



LM27308 7849000277 5713416001312 Alu. profil 8, m/klar cover - 2500 mm
LM27308 7849000277 5713416001312 Alu. profile 8, with clear cover - 2500 mm



VN27108x1 7849000280 5713416001329 Alu. profil 8, endprop m/hul for ledning
VN27108x1 7849000280 5713416001329 Alu. profile 8, end cap with hole for cable



VN27108x2 7849000293 5713416001336 Alu. profil 8, endprop u/hul
VN27108x2 7849000293 5713416001336 Alu. profile 8, end cap without hole



VN27108x3 7849000303 5713416001343 Alu. profil 8, plastik clips til montage
VN27108x3 7849000303 5713416001343 Alu. profile 8, plastic clips for mounting



Hovedkomponenter:
Aluminium led profil er en anodiseret 6063-T5.
Opal matte omslag og klare omslag er PMMA.

Main components:
Aluminium led profile is an anodised 6063-T5.
Opal matte cover and clear cover is PMMA.

9 PROFIL

ALU. PROFIL 9 / ALU. PROFILE 9



VARE NR. ITEM NO.	LM. NR. LM. NO.	EAN NR. EAN NO.	BESKRIVELSE DESCRIPTION
LM27109	7849000183	5713416001350	Alu. profil 9, m/opalcover - 2500 mm
LM27109	7849000183	5713416001350	Alu. profile 9, with opal cover - 2500 mm
LM27309	7849000170	5713416001367	Alu. profil 9, m/klar cover - 2500 mm
LM27309	7849000170	5713416001367	Alu. profile 9, with clear cover - 2500 mm
VN27109x1	7849000196	5713416001374	Alu. profil 9, endeprop m/hul for ledning
VN27109x1	7849000196	5713416001374	Alu. profile 9, end cap with hole for cable
VN27109x2	7849000086	5713416001381	Alu. profil 9, endeprop u/hul
VN27109x2	7849000086	5713416001381	Alu. profile 9, end cap without hole
VN27109x3	7849000099	5713416001398	Alu. profil 9, plastik clips t/montage
VN27109x3	7849000099	5713416001398	Alu. profile 9, plastic clips for mounting

Hovedkomponenter:
Aluminium led profil er en anodiseret 6063-T5.
Opal matte omslag og klare omslag er PMMA.

Main components:
Aluminium led profile is an anodised 6063-T5.
Opal matte cover and clear cover is PMMA.

10 PROFIL

ALU. PROFIL 10 / ALU. PROFILE 10



Vare nr. Item no.	LM. nr. LM. no.	EAN nr. EAN no.	Beskrivelse Description
LM27110	7849000206	5713416001404	Alu. profil 10, m/opal cover - 2500 mm
LM27110	7849000206	5713416001404	Alu. profile 10, with opal cover - 2500 mm
LM27310	7849000316	5713416001411	Alu. profil 10, m/klar cover - 2500 mm
LM27310	7849000316	5713416001411	Alu. profile 10, with clear cover - 2500 mm
VN27110x1	7849000219	5713416001428	Alu. profil 10, endeprop m/hul for ledning
VN27110x1	7849000219	5713416001428	Alu. profile 10, end cap with hole for cable
VN27110x2	7849000222	5713416001435	Alu. profil 10, endeprop u/hul
VN27110x2	7849000222	5713416001435	Alu. profile 10, end cap without hole
VN27110x3	7849000235	5713416001442	Alu. profil 10, plastik clips til montage - B19,7 x H9,5 x D14,6 mm
VN27110x3	7849000235	5713416001442	Alu. profile 10, plastic clips for mounting - W19,7 x H9,5 x D14,6 mm
VN27110x4			Alu. profil 10, metal clips til montage - B18,3 x H9,6 x D15 mm
VN27110x4			Alu. profile 10, metal clips for mounting - W18,3 x H9,6 x D15 mm

Hovedkomponenter:
Aluminium led profil er en anodiseret 6063-T5.
Opal matte omslag og klare omslag er PMMA.

Main components:
Aluminium led profile is an anodised 6063-T5.
Opal matte cover and clear cover is PMMA.

12 PROFIL

ALU. PROFIL 12 / ALU. PROFILE 12

LED

VARE NR. LM. NR. EAN NR. BESKRIVELSE
ITEM NO. LM. NO. EAN NO. DESCRIPTION

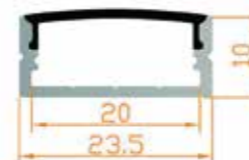

LM27112 7849990057 5713416001466 Alu. profil 12, m/opalcover - 2500 mm
LM27112 7849990057 5713416001466 Alu. profile 12, with opal cover - 2500 mm



LM27312 7849990060 5713416001459 Alu. profil 12, m/klar cover - 2500 mm
LM27312 7849990060 5713416001459 Alu. profile 12, with clear cover - 2500 mm



VN27112x1 7849990073 5713416001473 Alu. profil 12, endprop m/hul for ledning
VN27112x1 7849990073 5713416001473 Alu. profile 12, end cap with hole for cable



VN27112x2 7849990086 5713416001480 Alu. profil 12, endprop u/hul
VN27112x2 7849990086 5713416001480 Alu. profile 12, end cap without hole



VN27112x3 7849990099 5713416001497 Alu. profil 12, plastik clips t/montage
VN27112x3 7849990099 5713416001497 Alu. profile 12, plastic clips for mounting



Hovedkomponenter:
Aluminium led profil er en anodiseret 6063-T5.
Opal matte omslag og klare omslag er PMMA.

Main components:
Aluminium led profile is an anodised 6063-T5.
Opal matte cover and clear cover is PMMA.

14 PROFIL

ALU. PROFIL 14 / ALU. PROFILE 14

LED

VARE NR. LM. NR. EAN NR. BESKRIVELSE
ITEM NO. LM. NO. EAN NO. DESCRIPTION



LM27114 7849990109 5713416001503 Alu. profil 14, m/opalcover - 2500 mm
LM27114 7849990109 5713416001503 Alu. profile 14, with opal cover - 2500 mm



LM27314 7849990112 5713416001510 Alu. profil 14, m/klar cover - 2500 mm
LM27314 7849990112 5713416001510 Alu. profile 14, with clear cover - 2500 mm



VN27114x1 7849990125 5713416001527 Alu. profil 14, endprop m/hul for ledning
VN27114x1 7849990125 5713416001527 Alu. profile 14, end cap with hole for cable



VN27114x2 7849990138 5713416001534 Alu. profil 14, endprop u/hul
VN27114x2 7849990138 5713416001534 Alu. profile 14, end cap without hole



Leveres med montageskinne.
Supplied with mounting rail.



Hovedkomponenter:
Aluminium led profil er en anodiseret 6063-T5.
Opal matte omslag og klare omslag er PMMA.

Main components:
Aluminium led profile is an anodised 6063-T5.
Opal matte cover and clear cover is PMMA.

20 PROFIL

ALU. PROFIL 20 / ALU. PROFILE 20

LED

VARE NR.	LM. NR.	EAN NR.	BESKRIVELSE
ITEM NO.	LM. NO.	EAN NO.	DESCRIPTION

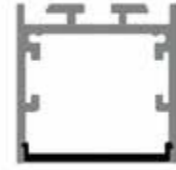

LM27120	7849990167	5713416001572	Alu. profil 20, m/opalcover - 2500 mm
LM27120	7849990167	5713416001572	Alu. profile 20, with opal cover - 2500 mm



LM27320	7849990170	5713416001589	Alu. profil 20, m/klar cover - 2500 mm
LM27320	7849990170	5713416001589	Alu. profile 20, with clear cover - 2500 mm



VN27120x2	7849990219	5713416002210	Alu. profil 20, endeprop u/hul
VN27120x2	7849990219	5713416002210	Alu. profile 20, end cap without hole



Leveres UDEN clips.
There are no clips for this profile.

Hovedkomponenter:
Aluminium led profil er en anodiseret 6063-T5.
Opal matte omslag og klare omslag er PMMA.

Main components:
Aluminium led profile is an anodised 6063-T5.
Opal matte cover and clear cover is PMMA.

23 PROFIL

ALU. PROFIL 23 / ALU. PROFILE 23

LED

OBS! - max. 5 mm LED bånd bredde / NOTE! - max. 5 mm LED strip width

VARE NR.	LM. NR.	EAN NR.	BESKRIVELSE
ITEM NO.	LM. NO.	EAN NO.	DESCRIPTION

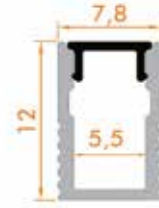

LM27123			Alu. profile 23, m/ frostet cover - 2500 mm
LM27123			Alu. profile 23, with frosted cover - 2500 mm



VN27123x1			Alu. profil 23, endeprop m/hul for ledning
VN27123x1			Alu. profile 23, end cap with hole



VN27120x2			Alu. profil 23, endeprop u/hul
VN27120x2			Alu. profile 23, end cap without hole



VN27120x3			Alu. profil 23, metal clips til montage
VN27120x3			Alu. profile 23, metal clips for mounting



Hovedkomponenter:
Aluminium led profil er en anodiseret 6063-T5.
Opal matte omslag og klare omslag er PMMA.

Main components:
Aluminium led profile is an anodised 6063-T5.
Opal matte cover and clear cover is PMMA.

ALU. FLADPROFILER /

ALU. FLAT PROFILES

VARE NR. ITEM NO.	LM. NR. LM. NO.	EAN NR. EAN NO.	BESKRIVELSE DESCRIPTION
----------------------	--------------------	--------------------	----------------------------

LM27002	7849990141	5713416001558	Alu. flad-profil 10 x 1 x 2500 mm flad/rå for afkøling
LM27002	7849990141	5713416001558	Alu. flat profile 10 x 1 x 2500 mm flat / raw for cooling



LM27001	7849990154	5713416001565	Alu. flad-profil 20 x 2 x 2500 mm flad/rå for afkøling
LM27001	7849990154	5713416001565	Alu. flat profile 20 x 2 x 2500 mm flat / raw for cooling



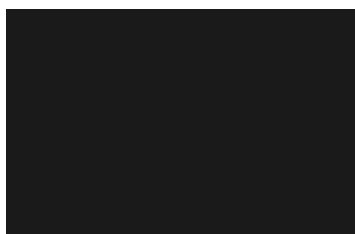
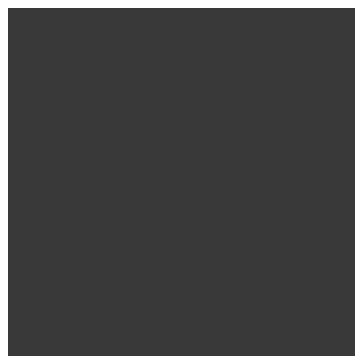
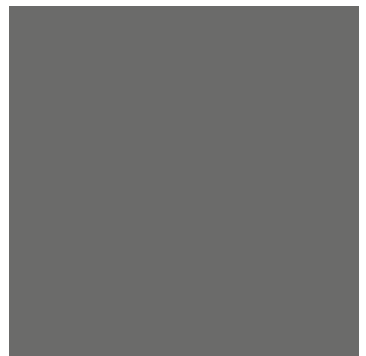
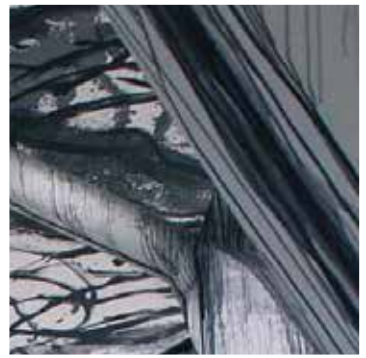
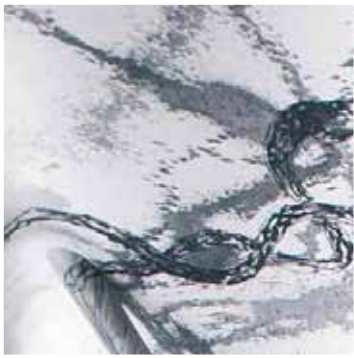

DEVELTRON

Tlf. +45 70 270 730
 Ribevej 13b • 8940 Randers SV
 develtron@develtron.dk
 www.develtron.dk