

Produktdatablad

Specifikationer



Harmony lampetrykshoved i plast for LED med fjeder-retur og plan trykflade i orange farve

El-nr.:

7517901530

ZB5AW353

Vigtig meddelelse: A change in appearance may be noted on the product but does not affect its use in terms of function and safety. This makes it compatible with our Universal LED blocks
EAN-nr: 3389110909982

Egenskaber

Produktserie	Harmony XB5
Produkttype	Hoved til lampetryk
Enhedsforkortelse	ZB5
Produktet passer med	Universal LED
Materiale og farve på frontring	Mørkegrå plast
Montagediameter	22 mm
Mindst mulige salgsantal	1
Hovedtype	Standard
Form på hoved	Rundt
Betjeningsprofil	fjeder-retur
Betjeningsprofil	Orange Plan, Uden mærkning
Yderligere egenskaber	Med almindelig linse

Produktinformationer

Bredde	29 mm
Højde	29 mm
Dybde	30 mm
Vægt	0,017 kg
Modstandsdygtighed overfor højtryksrensning	7000000 Pa ved 55 °C, distance : 0.1 m
Mekanisk holdbarhed	10000000 kredsløb
Kanalnavn	XALD 1...5 montagehuller XALK 2...5 montagehuller
Farve på trykflade eller linse	Orange
Mærkning	Uden mærkning
Kode for elektrisk sammensætning	M1 til <6 kontakter benytter enkelt blokke i Montering forfra med integreret LED M2 til <6 kontakter benytter enkelt og dobbelt blokke i Montering forfra med integreret LED M6 til <2 kontakter benytter enkelt blokke i Montering forfra med integreret LED og transformere M10 til <2 kontakter benytter enkelt blokke i Montering forfra med integreret LED MF1 til <2 kontakter benytter enkelt blokke i Montering forfra med integreret LED MR1 til <2 kontakter benytter enkelt blokke i Montering bagfra med integreret LED
Konstruktion	Som hoved og krop

Miljø

Beskyttelsesbehandling	TC
Omgivelsestemperatur ved opbevaring	-40...70 °C
Omgivelsestemperatur under drift	-40...70 °C
Overspændingskategori	Klasse II conforming to IEC 60536
IP kapslingsklasse	IP66 i henhold til IEC 60529 IP67 IP69 IP69K
NEMA kapslingsklasse	NEMA 13 NEMA 4X
IP kapslingsklasse	IK05 conforming to IEC 62262
Standarder	UL 508 CSA C22.2 No 14 IEC 60947-5-1 IEC 60947-5-4 IEC 60947-1 GB 14048.5 JIS C8201-5-1 JIS C8201-1
Produktcertificeringer	CSA DNV BV LROS (Lloyds register of shipping) UL listet
Vibrationsmodstand	5 gn (f= 2...500 Hz) conforming to IEC 60068-2-6
Modstandsdygtighed overfor stød	30 gn (varighed = 18 milisekund) til Halv sinusbølge acceleration i henhold til IEC 60068-2-27 50 gn (varighed = 11 milisekund) til Halv sinusbølge acceleration i henhold til IEC 60068-2-27

Forpakkingsinformation

Enhedstype af pakke 1	PCE
Antal enheder i pakke 1	1
Pakke 1 Højde	4,500 cm
Pakke 1 Længde	3,400 cm
Package 1 Length	5,400 cm
Pakke 1 Vægt	17,000 g
Enhedstype af pakke 2	S03
Antal enheder i pakke 2	300
Pakke 2 Højde	30,000 cm
Pakke 2 Bredde	30,000 cm
Pakke 2 Længde	40,000 cm
Pakke 2 Vægt	5,647 kg
Enhedstype af pakke 3	P06
Antal enheder i pakke 3	2400
Pakke 3 Højde	75,000 cm
Pakke 3 Bredde	60,000 cm
Pakke 3 Længde	80,000 cm
Pakke 3 Vægt	55,484 kg

Logistik informationer

Oprindelsesland FR

Garanti

Garanti 18 months

Environmental Data

Schneider Electric's mål er at opnå Net Zero-status i 2050 gennem partnerskaber med forsyningskæden, materialer med lavere påvirkning og cirkularitet via vores igangværende kampagne "Use Better, Use Longer, Use Again" for at forlænge produkternes levetid og genbrugelighed.

[Forklaring af Environmental Data >](#)

[Sådan vurderer vi produktets bæredygtighed >](#)

Miljøaftryk

CO2-belastning (kg CO2 eq.) 1

Miljøoplysning [Miljøprofil for produkt](#)

Use Better

Materialer og emballage

Pakke med genbrugspap Yes

Emballage uden plast Yes

[EU RoHS-direktivet](#) Proaktiv overensstemmelse (produkt ikke omfattet af EU RoHS)

SCIP-nummer D53aa77c-03d8-485e-b9e5-e24d3681bf88

Reach-forordning [REACH-erklæring](#)

Use Again

Ompakning og genfremstilling

Cirkularitetsprofil [Oplysninger om udtjent udstyr](#)

Returnering No

Dimensions Drawings

Dimensions

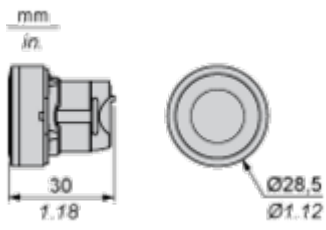

Mounting and Clearance

Panel Cut-out for Pushbuttons, Switches and Pilot Lights (Finished Holes, Ready for Installation)

Connection by Screw Clamp Terminals or Plug-in Connectors or on Printed Circuit Board



- (1) Diameter on finished panel or support
- (2) For selector switches and Emergency stop buttons, use of an anti-rotation plate type ZB5AZ902 is recommended.
- (3) $\varnothing 22.5$ mm recommended ($\varnothing 22.3_0^{+0.4}$) / $\varnothing 0.89$ in. recommended ($\varnothing 0.88$ in. $_0^{+0.016}$)

Connections	a in mm	a in in.	b in mm	b in in.
By screw clamp terminals or plug-in connector	40	1.57	30	1.18
By Faston connectors	45	1.77	32	1.26
On printed circuit board	30	1.18	30	1.18

Detail of Lug Recess



- (1) Diameter on finished panel or support
- (2) For selector switches and Emergency stop buttons, use of an anti-rotation plate type ZB5AZ902 is recommended.
- (3) $\varnothing 22.5$ mm recommended ($\varnothing 22.3_0^{+0.4}$) / $\varnothing 0.89$ in. recommended ($\varnothing 0.88$ in. $_0^{+0.016}$)

Pushbuttons, Switches and Pilot Lights for Printed Circuit Board Connection

Panel Cut-outs (Viewed from Installer's Side)

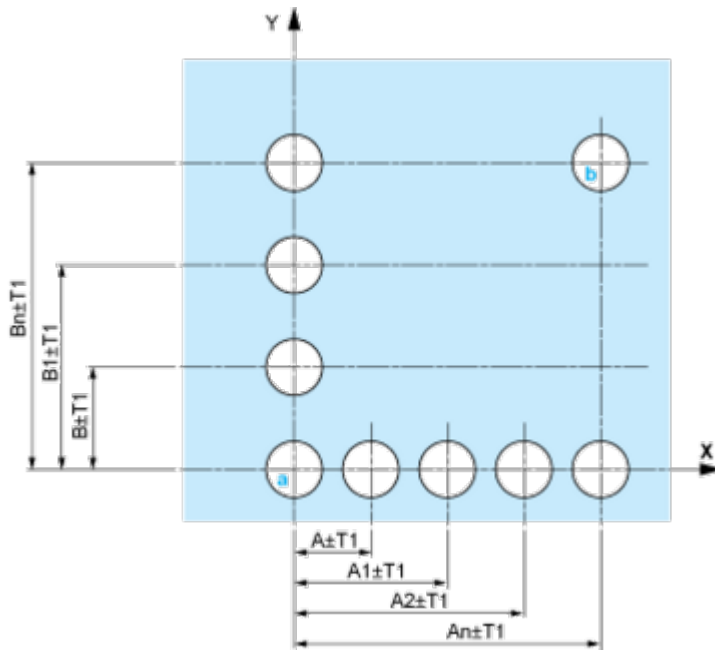

A: 30 mm min. / 1.18 in. min.

B: 40 mm min. / 1.57 in. min.

Printed Circuit Board Cut-outs (Viewed from Electrical Block Side)

Dimensions in mm

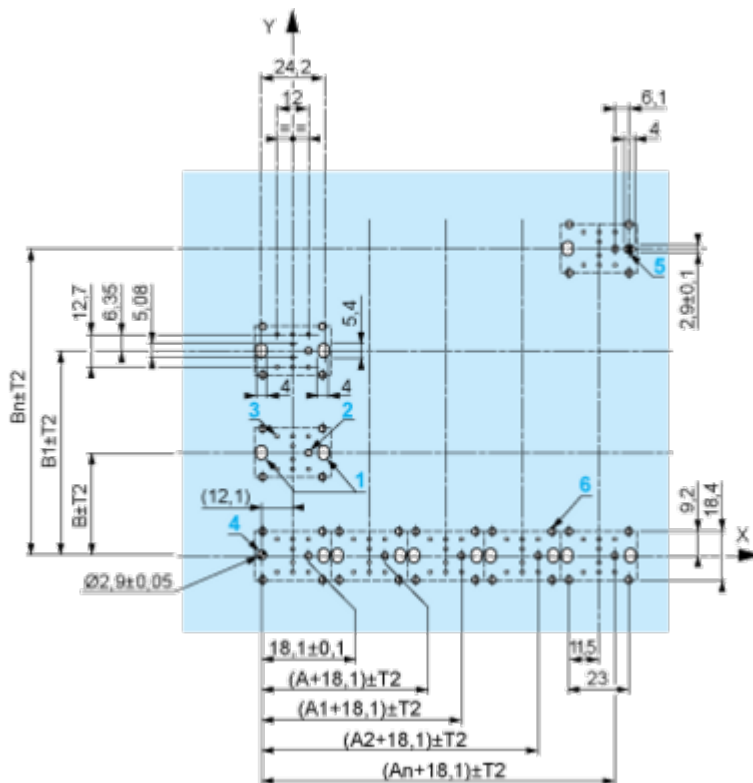

A: 30 mm min.

B: 40 mm min.

Dimensions in in.

- (1) Head ZB5AD•
- (2) Panel
- (2) Nut
- (4) Printed circuit board

Mounting of Adapter (Socket) ZBZ01•

- 1 2 elongated holes for ZBZ006 screw access
- 2 1 hole \varnothing 2.4 mm \pm 0.05 / 0.09 in. \pm 0.002 for centring adapter ZBZ01•
- 3 8 \times \varnothing 1.2 mm / 0.05 in. holes
- 4 1 hole \varnothing 2.9 mm \pm 0.05 / 0.11 in. \pm 0.002, for aligning the printed circuit board (with cut-out marked **a**)
- 5 1 elongated hole for aligning the printed circuit board (with cut-out marked **b**)
- 6 4 holes \varnothing 2.4 mm / 0.09 in. for clipping in adapter ZBZ01•

Dimensions An + 18.1 relate to the \varnothing 2.4 mm \pm 0.05 / 0.09 in. \pm 0.002 holes for centring adapter ZBZ01•.

Technical Illustration

Dimensions

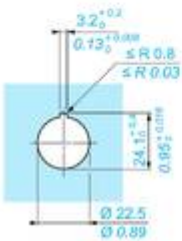
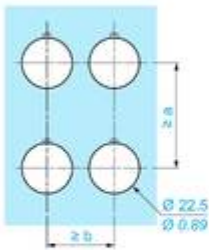
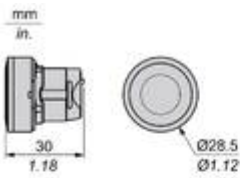

		a (mm)	a (in.)	b (mm)	b (in.)
	ZBE..... ZBV.....	40	1.57	30	1.18
	ZBE.....3 ZBV.....3	45	1.77	32	1.26
	ZBE.....4 ZBV.....4	40	1.57	30	1.18
	ZBE.....5 ZBV.....5	50	1.97	30	1.18
	ZBE.....9 ZBV.....9	40	1.57	30	1.18
	ZBRT... ZBRV1	40	1.57	30	1.18





Offer Marketing Illustration

Product benefits / Features

The graphic features a green background with the title "Features" and subtitle "Harmony XB4/XB5 Illuminated functions". It contains four feature descriptions, each with an icon and a corresponding product image: 1. "NEW universal LED Block for all colors" with a square icon and a green LED block. 2. "Simple stock management" with a person icon and a black XB4/XB5 illuminated function unit. 3. "Improved installation time and easy selection" with a plug icon and a yellow illuminated button. 4. "Improved color intensity and brightness" with a sun icon and a red illuminated button.

Features

Harmony XB4/XB5 Illuminated functions

-  NEW universal LED Block for all colors
-  Simple stock management
-  Improved installation time and easy selection
-  Improved color intensity and brightness

Offer Marketing Illustration

Product benefits / Features

Technical Benefits

Harmony XB5

Conformity with IEC, UL, CSA, CCC EAC, and JIS standards, as well as CE marking and marine approvals

Up to IP66, 67, 69, 69K, and type 4X protection ratings

High vibration resistance with shake-proof terminal screws



Operating temperature from -40°C to 70°C

Shock protection level up to IK06

Secure switching of inductive or heavy DC loads directly – 100 000 operations at 10A, 24V dc

Offer Marketing Illustration

Product benefits / Features

Features Harmony XB5



- 

Quick and easy assembly and disassembly
- 

Excellent mechanical connection with operator head
- 

Various types of connection: screw clamp, connector, Faston connector, spring terminal, or printed circuit board
- 

Large set of accessories to customize your panels
- 

Robustness to withstand harsh environments

Image of product / Alternate images

Alternative







Image of product in real life situation

