

Produktdatablad

Specifikationer



Harmony dobbelt trykknaphoved i metal med en hvid og en sort trykflade

El-nr.:

7517801465

ZB4BA7120

EAN-nr: 3389119043816

Egenskaber

Produktserie	Harmony XB4
Produkttype	Hoved til dobbelt trykknop
Enhedsforkortelse	ZB4
Materiale og farve på frontring	Forkromet metal
Montagediameter	22 mm
Hovedtype	Standard
Mindst mulige salgsantal	1
Form på hoved	Rektangulær
Betjeningsprofil	fjeder-retur
Betjeningsprofil	2 plan trykknapper
Betjeningsbeskrivelse	Hvid uden mærkning - sort uden mærkning

Produktinformationer

Vægt	0,056 kg
Modstandsdygtighed overfor højtryksrensning	7000000 Pa ved 55 °C, distance : 0.1 m
Farve på mærkning	Hvid mærkning ved grøn, rød eller sort trykflade Sort mærkning ved hvid trykflade
Betjeningsprofil	Sort Plan, Uden mærkning Hvid Plan, Uden mærkning
Mekanisk holdbarhed	1000000 kredsløb
Kode for elektrisk sammensætning	C3 til <6 kontakter benytter enkelt blokke i Montering forfra C4 til <6 kontakter benytter enkelt og dobbelt blokke i Montering forfra C14 til <2 kontakter benytter enkelt blokke i Montering forfra
Konstruktion	Som løsdele

Miljø

Omgivelsestemperatur ved opbevaring	-40...70 °C
Omgivelsestemperatur under drift	-40...70 °C
Beskyttelsesklasse	Klasse I i henhold til IEC 60536
IP kapslingsklasse	IP67 i henhold til IEC 60529 IP69 i henhold til IEC 60529
NEMA kapslingsklasse	NEMA 13 NEMA 4X
IP kapslingsklasse	IK06 conforming to IEC 50102

Standarder	IEC 60947-1 IEC 60947-5-1 JIS C8201-5-1 IEC 60947-5-5 UL 508 IEC 60947-5-4 CSA C22.2 No 14 JIS C8201-1
Produktcertificeringer	CSA LROS (Lloyds register of shipping) BV UL listet DNV
Vibrationsmodstand	5 gn (f= 2...500 Hz) conforming to IEC 60068-2-6
Modstandsdygtighed overfor stød	30 gn (varighed = 18 milisekund) til Halv sinusbølge acceleration i henhold til IEC 60068-2-27 50 gn (varighed = 11 milisekund) til Halv sinusbølge acceleration i henhold til IEC 60068-2-27

Forpakkingsinformation

Enhedstype af pakke 1	PCE
Antal enheder i pakke 1	1
Pakke 1 Højde	3,5 cm
Pakke 1 Længde	5,4 cm
Package 1 Length	5,9 cm
Pakke 1 Vægt	57,0 g
Enhedstype af pakke 2	S03
Antal enheder i pakke 2	200
Pakke 2 Højde	30 cm
Pakke 2 Bredde	30 cm
Pakke 2 Længde	40 cm
Pakke 2 Vægt	11,94 kg

Logistik informationer

Oprindelsesland	FR
------------------------	----

Garanti

Garanti	18 months
----------------	-----------

Environmental Data

Schneider Electric's mål er at opnå Net Zero-status i 2050 gennem partnerskaber med forsyningskæden, materialer med lavere påvirkning og cirkularitet via vores igangværende kampagne "Use Better, Use Longer, Use Again" for at forlænge produkternes levetid og genbrugelighed.

[Forklaring af Environmental Data](#) >

[Sådan vurderer vi produktets bæredygtighed](#) >

Miljøfodaftryk

CO2-belastning (kg CO2 eq.) 1

Miljøoplysning [Miljøprofil for produkt](#)

Use Better

Materialer og emballage

Pakke med genbrugspap Yes

Emballage uden plast Yes

[EU RoHS-direktivet](#)

Proaktiv overensstemmelse (produkt ikke omfattet af EU RoHS)

Reach-forordning

[REACH-erklæring](#)

Use Again

Ompakning og genfremstilling

Cirkularitetsprofil [Oplysninger om udtjent udstyr](#)

Returnering No

Dimensions Drawings

Dimensions

Without Boot

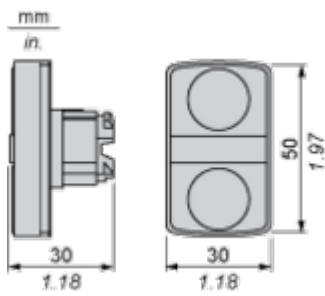

Without Boot ZBA708

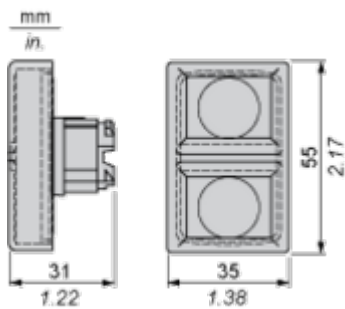

Mounting and Clearance

Panel Cut-out for Pushbuttons, Switches and Pilot Lights (Finished Holes, Ready for Installation)

Connection by Screw Clamp Terminals or Plug-in Connectors or on Printed Circuit Board	Connection by Faston Connectors
	
<p>(1) Diameter on finished panel or support</p> <p>(2) 40 mm min. / 1.57 in. min.</p> <p>(3) 30 mm min. / 1.18 in. min.</p> <p>(4) $\varnothing 22.5 \text{ mm} / 0.89 \text{ in. recommended } (\varnothing 22.3 \text{ mm }_0^{+0.4} / 0.88 \text{ in. }_0^{+0.016})$</p> <p>(5) 45 mm min. / 1.78 in. min.</p> <p>(6) 32 mm min. / 1.26 in. min.</p>	

Pushbuttons, Switches and Pilot Lights for Printed Circuit Board Connection

Panel Cut-outs (Viewed from Installer's Side)



A: 30 mm min. / 1.18 in. min.

B: 40 mm min. / 1.57 in. min.

Printed Circuit Board Cut-outs (Viewed from Electrical Block Side)

Dimensions in mm

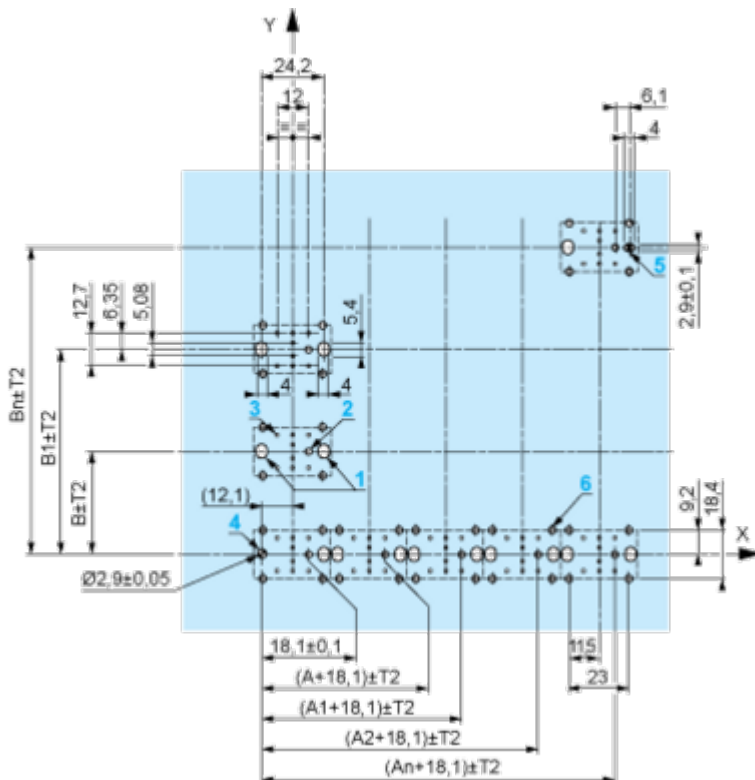

A: 30 mm min.

B: 40 mm min.

Dimensions in in.

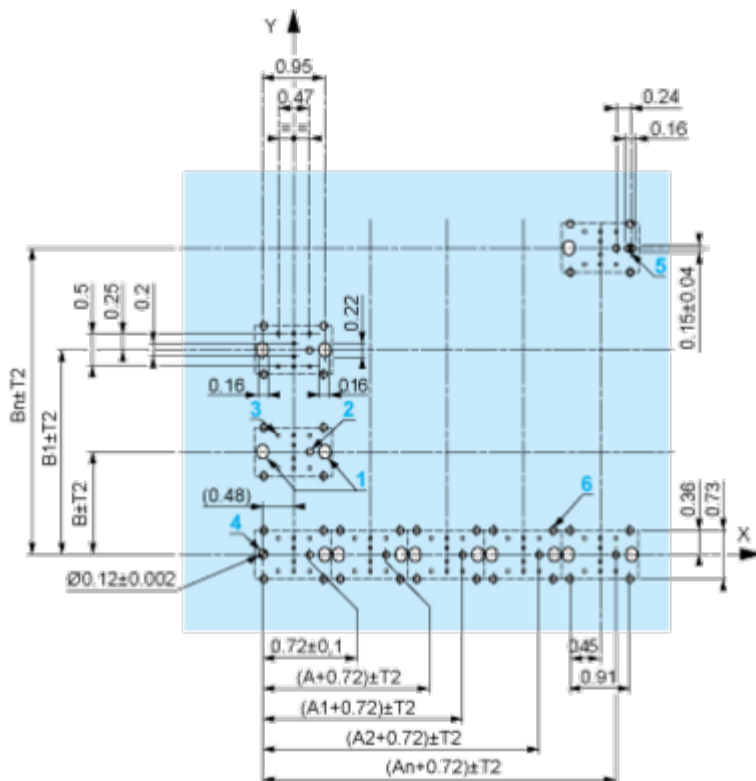

A: 1.18 in. min.

B: 1.57 in. min.

General Tolerances of the Panel and Printed Circuit Board

The cumulative tolerance must not exceed 0.3 mm / 0.012 in: T1 + T2 = 0.3 mm max.

Installation Precautions

- Minimum thickness of circuit board: 1.6 mm / 0.06 in.
- Cut-out diameter: 22.4 mm ± 0.1 / 0.88 in. ± 0.004
- Orientation of body/fixing collar ZB4 BZ009: ± 2° 30' (excluding cut-outs marked a and b).
- Tightening torque of screws ZBZ 006: 0.6 N.m (5.3 lbf.in) max.
- Allow for one ZB4 BZ079 fixing collar/pillar and its fixing screws:
 - every 90 mm / 3.54 in. horizontally (X), and 120 mm / 4.72 in. vertically (Y).
 - with each selector switch head (ZB4 BD*, ZB4 BJ*, ZB4 BG*).

The fixing centers marked a and b are diagonally opposed and must align with those marked 4 and 5.



(1) Panel

(2) Printed circuit board

Mounting of Adapter (Socket) ZBZ 01•

- 1 2 elongated holes for ZBZ 006 screw access
- 2 1 hole \varnothing 2.4 mm \pm 0.05 / 0.09 in. \pm 0.002 for centring adapter ZBZ 01•
- 3 8 \times \varnothing 1.2 mm / 0.05 in. holes
- 4 1 hole \varnothing 2.9 mm \pm 0.05 / 0.11 in. \pm 0.002, for aligning the printed circuit board (with cut-out marked a)
- 5 1 elongated hole for aligning the printed circuit board (with cut-out marked b)
- 6 4 holes \varnothing 2.4 mm / 0.09 in. for clipping in adapter ZBZ 01•

Dimensions An + 18.1 relate to the \varnothing 2.4 mm \pm 0.05 / 0.09 in. \pm 0.002 holes for centring adapter ZBZ 01•.

Technical Description

Electrical Composition Corresponding to Code C3

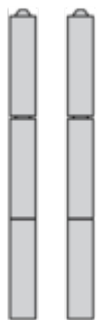

Electrical Composition Corresponding to Code C4



Electrical Composition Corresponding to Codes C14, SF2 and SR2



Legend

Single contact



Double contact



Light block



Possible location



Technical Illustration

Dimensions

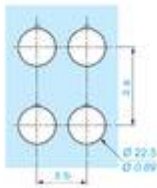
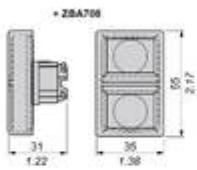
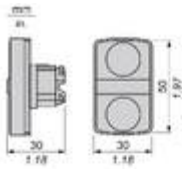

		a (mm)	a (in.)	b (mm)	b (in.)
		40	1.57	30	1.18
ZBE*****	ZDV*****				
		45	1.77	32	1.26
ZBE*****5	ZDV*****5				
		40	1.57	30	1.18
ZDE*****4	ZDV*****4				
		50	1.97	30	1.18
ZDE*****5	ZDV*****5				
		40	1.57	30	1.18
ZDE*****9	ZDV*****9				
		40	1.57	30	1.18
ZBRT*	ZBRV1				

Offer Marketing Illustration

Product benefits / Features

Technical Benefits

Harmony XB4

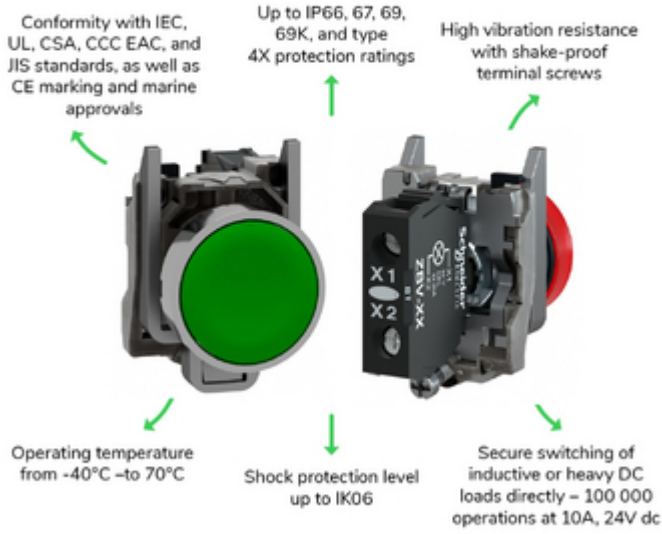

Offer Marketing Illustration

Product benefits / Features

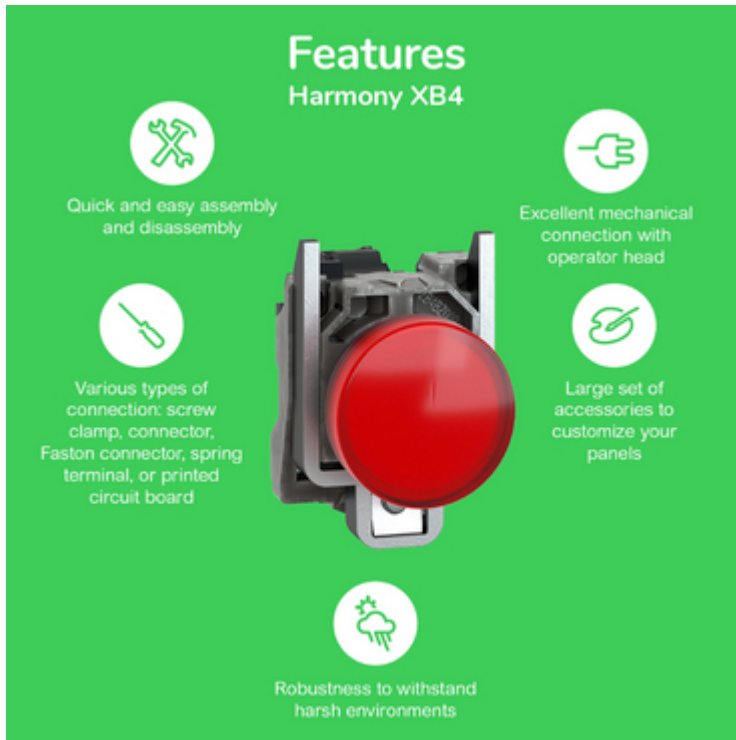

The infographic features a central image of a red Schneider XB4 circuit breaker. Surrounding this central image are five circular icons, each with a corresponding text description of a product feature. The background is a solid green color.

Features Harmony XB4

- Quick and easy assembly and disassembly** (Icon: crossed wrench and screwdriver)
- Excellent mechanical connection with operator head** (Icon: hand holding a plug)
- Various types of connection: screw clamp, connector, Faston connector, spring terminal, or printed circuit board** (Icon: screwdriver)
- Large set of accessories to customize your panels** (Icon: plug with a slash through it)
- Robustness to withstand harsh environments** (Icon: lightning bolt and rain cloud)

Image of product / Alternate images

Alternative

