



## Harmony signallampe komplet med LED i rød farve og 230-240VAC forsyning

El-nr.:  
7517800466

XB4BVM4

**Vigtig meddelelse: A change in appearance may be noted on the product but does not affect its use in terms of function and safety. This makes it compatible with our Universal LED blocks**  
EAN-nr: 3389110892017

### Egenskaber

Produktserie	Harmony XB4
Produkttype	Signallampe
Enhedsforkortelse	XB4
Materiale og farve på frontring	Forkromet metal
Materiale på fastgørelseskrop	Zamak
Montagediameter	22,5 mm
Hovedtype	Standard
Mindst mulige salgsantal	1
Form på hoved	Rundt
Farve på trykflade eller linse	Rød
Yderligere egenskaber	Med almindelig linse
Lyskilde	Universal LED
Fatning	Integreret LED
Farve på lyskilde	Rød
Nominal forsyningspænding [Us]	230...240 V AC 50/60 Hz

### Produktinformationer

Højde	47 mm
bredde	30 mm
Dybde	54 mm
Klemmenavn ISO n°1	(X1-X2)PL
Vægt	0,08 kg
Modstandsdygtighed overfor højtryksrensning	7000000 Pa ved 55 °C, distance : 0.1 m
Tilslutningklemmer	Skrukeklemmer, = 2 x 1.5 mm² Med kabeltulle i henhold til IEC 60947-1 Skrukeklemmer, 1 x 0.22...2 x 2.5 mm² Uden kabeltulle i henhold til IEC 60947-1
Isolationsspænding [Ui]	250 V (forureningsgrad 3) i henhold til IEC 60947-1
Impulsmodstandsspænding [Uimp]	4 kV i henhold til IEC 60947-1
Signaltyper	Fast
Strømforbrug	14 mA
Levetid	100000 time Ved nominal spænding og 25 °C

<b>Modstand mod fysiske stød</b>	1 kV i henhold til IEC 61000-4-5
<b>Konstruktion</b>	Komplet enhed
<b>Grænse for forsyningspænding</b>	195...264 V AC

## Miljø

<b>Beskyttelsesbehandling</b>	TH
<b>Omgivelsestemperatur ved opbevaring</b>	-40...70 °C
<b>Omgivelsestemperatur under drift</b>	-40...70 °C
<b>Beskyttelsesklasse</b>	Klasse I i henhold til IEC 60536
<b>IP kapslingsklasse</b>	IP66 i henhold til IEC 60529 IP67 IP69 IP69K
<b>NEMA kapslingsklasse</b>	NEMA 13 NEMA 4X
<b>IP kapslingsklasse</b>	IK06 conforming to IEC 50102
<b>Standarder</b>	JIS C8201-5-1 CSA C22.2 No 14 UL 508 IEC 60947-5-1 IEC 60947-5-5 IEC 60947-5-4 IEC 60947-1 JIS C8201-1
<b>Produktcertificeringer</b>	CSA UL listet
<b>Vibrationsmodstand</b>	5 gn (f= 12...500 Hz) conforming to IEC 60068-2-6
<b>Modstandsdygtighed overfor stød</b>	30 gn (varighed = 18 milisekund) til Halv sinusbølge acceleration i henhold til IEC 60068-2-27 50 gn (varighed = 11 milisekund) til Halv sinusbølge acceleration i henhold til IEC 60068-2-27
<b>Modstandsdygtighed overfor transienter</b>	2 kV i henhold til IEC 61000-4-4
<b>Modstandsdygtighed overfor elektromagnetiske felter</b>	10 V/m i henhold til IEC 61000-4-3
<b>Modstandsdygtighed overfor statisk elektricitet</b>	6 kV Ved kontakt (på metaldele) i henhold til IEC 61000-4-2 8 kV I fri luft (i isolerende dele) i henhold til IEC 61000-4-2
<b>Elektromagnetisk stråling</b>	Klasse B i henhold til IEC 55011

## Forpakkingsinformation

<b>Enhedstype af pakke 1</b>	PCE
<b>Antal enheder i pakke 1</b>	1
<b>Pakke 1 Højde</b>	3,400 cm
<b>Pakke 1 Længde</b>	5,400 cm
<b>Package 1 Length</b>	8,800 cm
<b>Pakke 1 Vægt</b>	79,000 g
<b>Enhedstype af pakke 2</b>	BB1
<b>Antal enheder i pakke 2</b>	5
<b>Pakke 2 Højde</b>	3,400 cm
<b>Pakke 2 Bredde</b>	8,800 cm
<b>Pakke 2 Længde</b>	26,500 cm

Pakke 2 Vægt	398,000 g
Enhedstype af pakke 3	S03
Antal enheder i pakke 3	150
Pakke 3 Højde	30,000 cm
Pakke 3 Bredde	30,000 cm
Pakke 3 Længde	40,000 cm
Pakke 3 Vægt	12,488 kg

## Logistik informationer

Oprindelsesland	FR
-----------------	----

## Garanti

Garanti	18 months
---------	-----------

## Environmental Data

Schneider Electric's mål er at opnå Net Zero-status i 2050 gennem partnerskaber med forsyningskæden, materialer med lavere påvirkning og cirkularitet via vores igangværende kampagne "Use Better, Use Longer, Use Again" for at forlænge produkternes levetid og genbrugelighed.

[Forklaring af Environmental Data >](#)

[Sådan vurderer vi produktets bæredygtighed >](#)

### Miljøfodaftryk

CO2-belastning (kg CO2 eq.) 3

Miljøoplysning [Miljøprofil for produkt](#)

### Use Better

#### Materialer og emballage

Pakke med genbrugspap Yes

Emballage uden plast Yes

[EU RoHS-direktivet](#)

Proaktiv overensstemmelse (produkt ikke omfattet af EU RoHS)

SCIP-nummer 3d14fd98-3859-4733-a5ee-a3016769973c

Reach-forordning [REACH-erklæring](#)

### Use Again

#### Ompakning og genfremstilling

Cirkularitetsprofil [Oplysninger om udtjent udstyr](#)

Returnering No

WEEE

 Produktet skal bortskaffes på EU's markeder efter en specifik affaldsindsamling og må aldrig ende i skraldespande

Dimensions Drawings

Dimensions

---

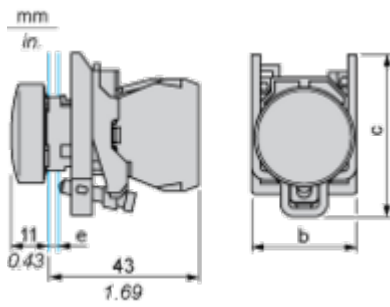

**e** : clamping thickness: 1 to 6 mm / 0.04 to 0.24 in.

**b** : 30 mm / 1.18 in.

**c** : 46.5 mm / 1.83 in.

Mounting and Clearance

Panel Cut-out for Pushbuttons, Switches and Pilot Lights (Finished Holes, Ready for Installation)

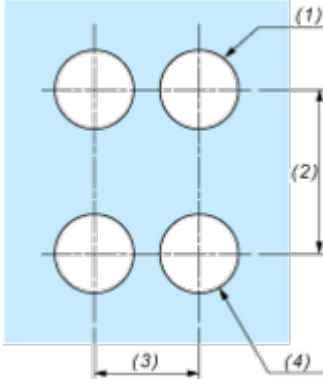
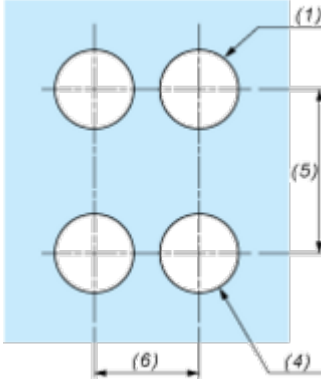
Connection by Screw Clamp Terminals or Plug-in Connectors or on Printed Circuit Board	Connection by Faston Connectors
	
<p>(1) Diameter on finished panel or support                  (2) 40 mm min. / 1.57 in. min.                  (3) 30 mm min. / 1.18 in. min.                  (4) <math>\varnothing 22.5 \text{ mm} / 0.89 \text{ in. recommended } (\varnothing 22.3 \text{ mm }_0^{+0.4} / 0.88 \text{ in. }_0^{+0.016})</math>                  (5) 45 mm min. / 1.78 in. min.                  (6) 32 mm min. / 1.26 in. min.</p>	

Technical Illustration

Dimensions

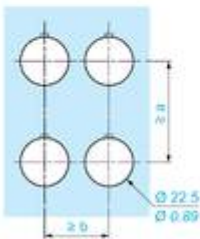
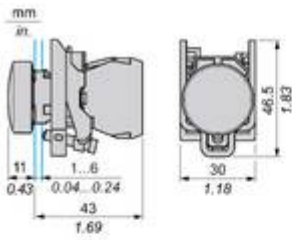

		a (mm)	a (in.)	b (mm)	b (in.)
		40	1.57	30	1.18
ZBE.....	ZBV.....				
		45	1.77	32	1.26
ZBE.....3	ZBV.....3				
		40	1.57	30	1.18
ZBE.....4	ZBV.....4				
		50	1.97	30	1.18
ZBE.....5	ZBV.....5				
		40	1.57	30	1.18
ZBE.....9	ZBV.....9				
		40	1.57	30	1.18
ZBRT•	ZBRV1				

Offer Marketing Illustration

Product benefits / Features

---

**Features**  
Harmony XB4/XB5 Illuminated functions

NEW universal LED Block for all colors

Simple stock management

Improved installation time and easy selection

Improved color intensity and brightness

The image features a green background with the title 'Features' and subtitle 'Harmony XB4/XB5 Illuminated functions'. It displays four key benefits, each with a circular icon and a corresponding photograph of the product. The benefits are: 1. 'NEW universal LED Block for all colors' with a square icon containing a smaller square. 2. 'Simple stock management' with an icon of a person holding a document. 3. 'Improved installation time and easy selection' with a circular arrow icon. 4. 'Improved color intensity and brightness' with a sun icon. The product images show various colored buttons (green, red, yellow) and their internal LED components.

Offer Marketing Illustration

Product benefits / Features

---

## Technical Benefits

### Harmony XB4

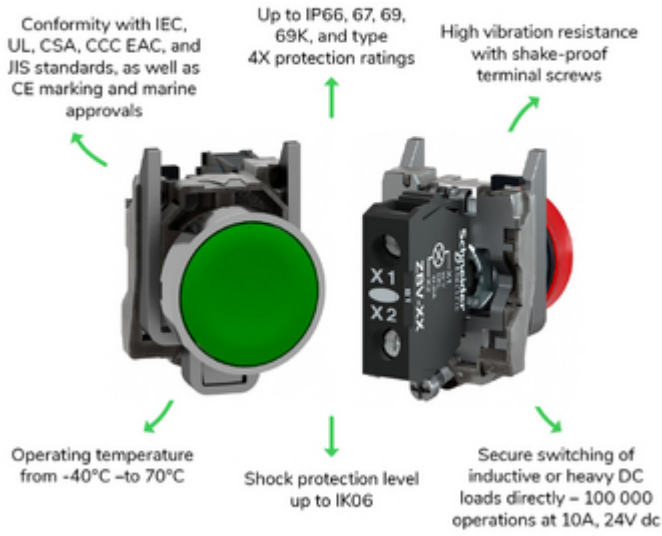

Offer Marketing Illustration

Product benefits / Features

---

### Features Harmony XB4

- Quick and easy assembly and disassembly
- Excellent mechanical connection with operator head
- Various types of connection: screw clamp, connector, Faston connector, spring terminal, or printed circuit board
- Large set of accessories to customize your panels
- Robustness to withstand harsh environments

Image of product / Alternate images

Alternative

---



