

Produktdatablad

Specifikationer



Harmony drejeregreb i plast med et kort sort greb med 2 faste positioner

El-nr.:
7517901307

ZB5AD2

EAN-nr: 3389110904963

Egenskaber

Produktserie	Harmony XALF Harmony XB5
Produkttype	Hoved til drejefafbryder
Enhedsforkortelse	ZB5
Materiale og farve på frontring	Mørkegrå plast
Montagediameter	22 mm
Hovedtype	Standard
Mindst mulige salgsantal	1
Form på hoved	Rundt
Betjeningsprofil	faste positioner
Betjeningsprofil	Sort Kort drejeregreb
Antal positioner	2 positioner 90°

Produktinformationer

Bredde	29 mm
Højde	29 mm
Dybde	46 mm
Vægt	0,017 kg
Mekanisk holdbarhed	1000000 kredsløb
Kanalnavn	XALD 1...5 montagehuller XALK 2...5 montagehuller
Kode for elektrisk sammensætning	C3 til <6 kontakter benytter enkelt blokke i Montering forfra C4 til <6 kontakter benytter enkelt og dobbelt blokke i Montering forfra C5 til <5 kontakter benytter enkelt blokke i Montering forfra C6 til <5 kontakter benytter enkelt og dobbelt blokke i Montering forfra C7 til <4 kontakter benytter enkelt blokke i Montering forfra C8 til <4 kontakter benytter enkelt og dobbelt blokke i Montering forfra C11 til <3 kontakter benytter enkelt blokke i Montering forfra C15 til <1 kontakter benytter enkelt blokke i Montering forfra SF1 til <3 kontakter benytter enkelt blokke i Montering forfra SR1 til <3 kontakter benytter enkelt blokke i Montering bagfra
Konstruktion	Som løsdele
Miljø	
Beskyttelsesbehandling	TH
Omgivelsestemperatur ved opbevaring	-40...70 °C
Omgivelsestemperatur under drift	-40...70 °C

Ansvarsfraskrivelse: Denne dokumentation er ikke tænkt som en erstatning for og kan ikke anvendes til at afgøre egnetheden eller pålideligheden for disse produkter til bestemte anvendelsesformål.

Overspændingskategori	Klasse II conforming to IEC 60536
IP kapslingsklasse	IP67 i henhold til IEC 60529 IP69 i henhold til IEC 60529 IP69K
NEMA kapslingsklasse	NEMA 13 NEMA 4X
Modstandsdygtighed overfor højtryksrensning	7000000 Pa ved 55 °C, distance : 0.1 m
IP kapslingsklasse	IK06 conforming to IEC 50102
Standarder	JIS C8201-5-1 CSA C22.2 No 14 UL 508 IEC 60947-1 IEC 60947-5-4 IEC 60947-5-1 JIS C8201-1
Produktcertificeringer	DNV CSA BV LROS (Lloyds register of shipping) UL listet
Vibrationsmodstand	5 gn (f= 2...500 Hz) conforming to IEC 60068-2-6
Modstandsdygtighed overfor stød	30 gn (varighed = 18 milisekund) til Halv sinusbølge acceleration i henhold til IEC 60068-2-27 50 gn (varighed = 11 milisekund) til Halv sinusbølge acceleration i henhold til IEC 60068-2-27

Forpakkingsinformation

Enhedstype af pakke 1	PCE
Antal enheder i pakke 1	1
Pakke 1 Højde	3,700 cm
Pakke 1 Længde	5,400 cm
Package 1 Length	6,000 cm
Pakke 1 Vægt	24,000 g
Enhedstype af pakke 2	BB1
Antal enheder i pakke 2	5
Pakke 2 Højde	5,000 cm
Pakke 2 Bredde	3,400 cm
Pakke 2 Længde	26,500 cm
Pakke 2 Vægt	121,000 g
Enhedstype af pakke 3	S03
Antal enheder i pakke 3	200
Pakke 3 Højde	30,000 cm
Pakke 3 Bredde	30,000 cm
Pakke 3 Længde	40,000 cm
Pakke 3 Vægt	5,304 kg

Logistik informationer

Oprindelsesland	FR
------------------------	----

Garanti

Garanti

18 months

Environmental Data

Schneider Electric's mål er at opnå Net Zero-status i 2050 gennem partnerskaber med forsyningskæden, materialer med lavere påvirkning og cirkularitet via vores igangværende kampagne "Use Better, Use Longer, Use Again" for at forlænge produkternes levetid og genbrugelighed.

[Forklaring af Environmental Data](#) >

[Sådan vurderer vi produktets bæredygtighed](#) >

Miljøfodaftryk

CO2-belastning (kg CO2 eq.) 1

Miljøoplysning [Miljøprofil for produkt](#)

Use Better

Materialer og emballage

Pakke med genbrugspap No

Emballage uden plast No

[EU RoHS-direktivet](#) Proaktiv overensstemmelse (produkt ikke omfattet af EU RoHS)

Reach-forordning [REACH-erklæring](#)

Use Again

Ompakning og genfremstilling

Cirkularitetsprofil [Oplysninger om udtjent udstyr](#)

Returnering No

Dimensions Drawings

Dimensions

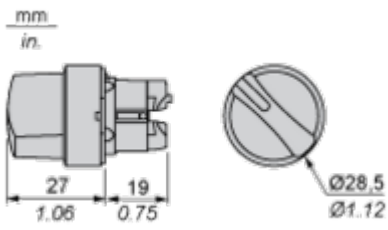

Mounting and Clearance

Panel Cut-out for Pushbuttons, Switches and Pilot Lights (Finished Holes, Ready for Installation)

Connection by Screw Clamp Terminals or Plug-in Connectors or on Printed Circuit Board



- (1) Diameter on finished panel or support
- (2) For selector switches and Emergency stop buttons, use of an anti-rotation plate type ZB5AZ902 is recommended.
- (3) Ø22.5 mm recommended ($\text{Ø}22.3_0^{+0.4}$) / Ø0.89 in. recommended ($\text{Ø}0.88_0^{+0.016}$)

Connections	a in mm	a in in.	b in mm	b in in.
By screw clamp terminals or plug-in connector	40	1.57	30	1.18
By Faston connectors	45	1.77	32	1.26
On printed circuit board	30	1.18	30	1.18

Detail of Lug Recess



- (1) Diameter on finished panel or support
- (2) For selector switches and Emergency stop buttons, use of an anti-rotation plate type ZB5AZ902 is recommended.
- (3) Ø22.5 mm recommended ($\text{Ø}22.3_0^{+0.4}$) / Ø0.89 in. recommended ($\text{Ø}0.88_0^{+0.016}$)

Pushbuttons, Switches and Pilot Lights for Printed Circuit Board Connection

Panel Cut-outs (Viewed from Installer's Side)

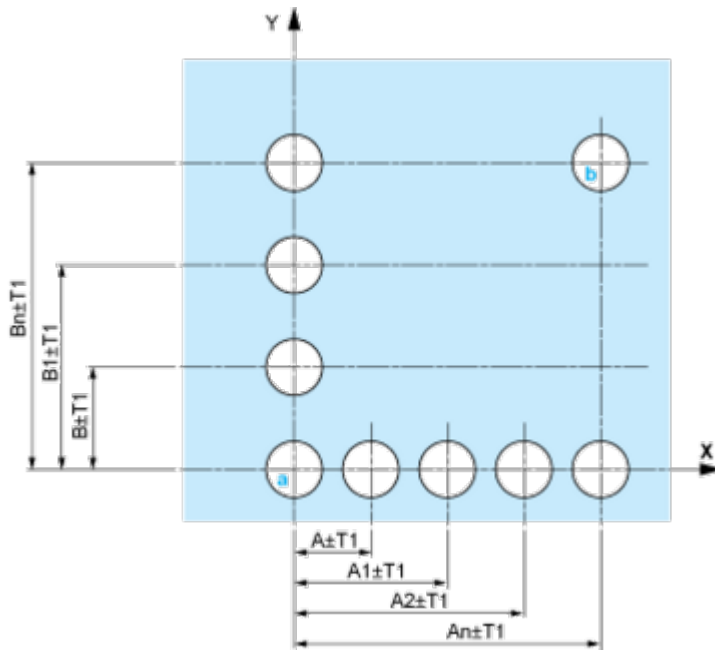

A: 30 mm min. / 1.18 in. min.
 B: 40 mm min. / 1.57 in. min.

Printed Circuit Board Cut-outs (Viewed from Electrical Block Side)

Dimensions in mm

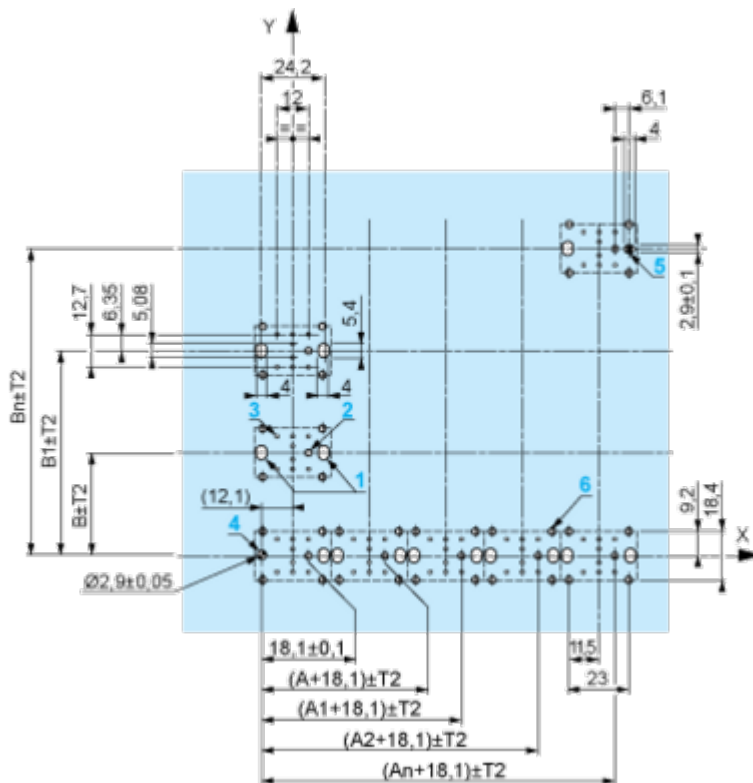

A: 30 mm min.
 B: 40 mm min.
 Dimensions in in.

- (1) Head ZB5AD•
- (2) Panel
- (2) Nut
- (4) Printed circuit board

Mounting of Adapter (Socket) ZBZ01•

- 1 2 elongated holes for ZBZ006 screw access
- 2 1 hole \varnothing 2.4 mm \pm 0.05 / 0.09 in. \pm 0.002 for centring adapter ZBZ01•
- 3 8 \times \varnothing 1.2 mm / 0.05 in. holes
- 4 1 hole \varnothing 2.9 mm \pm 0.05 / 0.11 in. \pm 0.002, for aligning the printed circuit board (with cut-out marked **a**)
- 5 1 elongated hole for aligning the printed circuit board (with cut-out marked **b**)
- 6 4 holes \varnothing 2.4 mm / 0.09 in. for clipping in adapter ZBZ01•

Dimensions An + 18.1 relate to the \varnothing 2.4 mm \pm 0.05 / 0.09 in. \pm 0.002 holes for centring adapter ZBZ01•.

Technical Description

Electrical Composition Corresponding to Code C3



Electrical Composition Corresponding to Code C4



Electrical Composition Corresponding to Code C5

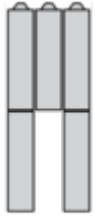

Electrical Composition Corresponding to Code C6



Electrical Composition Corresponding to Code C7

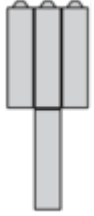

Electrical Composition Corresponding to Code C8

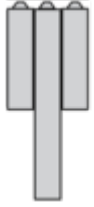

Electrical Composition Corresponding to Codes C9, C11, SF1 and SR1

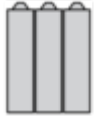

Electrical Composition Corresponding to Code C15

1 N/O

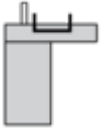

1 N/C

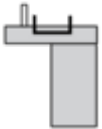

1 N/O + N/C or 1 N/O + N/O or 1 N/C + N/C

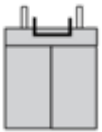

Legend

Single contact



Double contact



Light block



Possible location



Sequence of Contacts Fitted to 2-position Selector Switch Body

Position 315°



Push	Position	Top			
		Bottom			
	Location		Left	Centre	Right
	State		0	0	0
	Contacts		N/O	open	open
		N/C	closed	closed	closed

Position 45°



Push	Position	Top			
		Bottom			
	Location		Left	Centre	Right
	State		1	1	1
	Contacts		N/O	closed	closed
		N/C	open	open	open

Technical Illustration

Dimensions

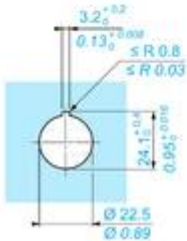
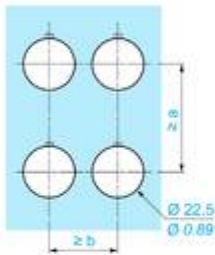
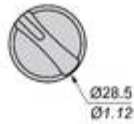
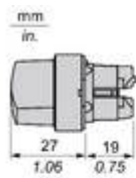

		a (mm)	a (in.)	b (mm)	b (in.)
		40	1.57	30	1.18
ZBE.....	ZBV.....				
		45	1.77	32	1.26
ZBE.....3	ZBV.....3				
		40	1.57	30	1.18
ZBE.....4	ZBV.....4				
		50	1.97	30	1.18
ZBE.....5	ZBV.....5				
		40	1.57	30	1.18
ZBE.....9	ZBV.....9				
		40	1.57	30	1.18
ZBRT•	ZBRV1				

Offer Marketing Illustration

Product benefits / Features

Features Harmony XB5



- 

Quick and easy assembly and disassembly
- 

Excellent mechanical connection with operator head
- 

Various types of connection: screw clamp, connector, Faston connector, spring terminal, or printed circuit board
- 

Robustness to withstand harsh environments
- 

Large set of accessories to customize your panels

Offer Marketing Illustration

Product benefits / Features

Technical Benefits

Harmony XB5

Conformity with IEC, UL, CSA, CCC EAC, and JIS standards, as well as CE marking and marine approvals

Up to IP66, 67, 69, 69K, and type 4X protection ratings

High vibration resistance with shake-proof terminal screws



Operating temperature from -40°C to 70°C

Shock protection level up to IK06

Secure switching of inductive or heavy DC loads directly – 100 000 operations at 10A, 24V dc

Image of product / Alternate images

Alternative





Image of product in real life situation

