

Produktdatablad

Specifikationer



Harmony signallampehoved i plast for LED med linse i grøn farve

El-nr.:

7517904773

ZB5AV033

Vigtig meddelelse: A change in appearance may be noted on the product but does not affect its use in terms of function and safety.

This makes it compatible with our Universal LED blocks

EAN-nr: 3389110908084

Egenskaber

Produktserie	Harmony XB5
Produkttype	Hoved til signallampe
Produktet passer med	Universal LED
Enhedsforkortelse	ZB5
Materiale og farve på frontring	Mørkegrå plast
Montagediameter	22 mm
Hovedtype	Standard
Mindst mulige salgsantal	1
Form på hoved	Rundt
Farve på trykflade eller linse	Grøn
Yderligere egenskaber	Med almindelig linse

Produktinformationer

Bredde	29 mm
Højde	29 mm
Dybde	31 mm
Vægt	0,017 kg
Kanalnavn	XALD 1...5 montagehuller XALK 2...5 montagehuller
Kode for elektrisk sammensætning	P1 i Montering forfra med integreret LED P2 i Montering forfra med integreret LED og transformere PF1 i Montering forfra med integreret LED PR1 i Montering bagfra med integreret LED
Konstruktion	Som løse dele

Miljø

Beskyttelsesbehandling	TH
Omgivelsestemperatur ved opbevaring	-40...70 °C
Omgivelsestemperatur under drift	-40...70 °C
Overspændingskategori	Klasse II conforming to IEC 60536
IP kapslingsklasse	IP66 i henhold til IEC 60529 IP67 i henhold til IEC 60529 IP69 i henhold til IEC 60529 IP69K i henhold til ISO 20653

NEMA kapslingsklasse	NEMA 13 NEMA 4X
Modstandsdygtighed overfor højtryksrensning	7000000 Pa ved 55 °C, distance : 0.1 m
IP kapslingsklasse	IK05 conforming to IEC 50102
Standarder	CSA C22.2 No 14 IEC 60947-5-5 IEC 60947-1 IEC 60947-5-4 JIS C8201-5-1 IEC 60947-5-1 UL 508 JIS C8201-1
Vibrationsmodstand	5 gn (f= 2...500 Hz) conforming to IEC 60068-2-6
Modstandsdygtighed overfor stød	30 gn (varighed = 18 milisekund) til Halv sinusbølge acceleration i henhold til IEC 60068-2-27 50 gn (varighed = 11 milisekund) til Halv sinusbølge acceleration i henhold til IEC 60068-2-27

Forpakkingsinformation

Enhedstype af pakke 1	PCE
Antal enheder i pakke 1	1
Pakke 1 Højde	4,500 cm
Pakke 1 Længde	3,400 cm
Package 1 Length	5,400 cm
Pakke 1 Vægt	16,000 g
Enhedstype af pakke 2	S03
Antal enheder i pakke 2	300
Pakke 2 Højde	30,000 cm
Pakke 2 Bredde	30,000 cm
Pakke 2 Længde	40,000 cm
Pakke 2 Vægt	5,260 kg
Enhedstype af pakke 3	P06
Antal enheder i pakke 3	2400
Pakke 3 Højde	75,000 cm
Pakke 3 Bredde	60,000 cm
Pakke 3 Længde	80,000 cm
Pakke 3 Vægt	50,788 kg

Logistik informationer

Oprindelsesland	FR
------------------------	----

Garanti

Garanti	18 months
----------------	-----------

Environmental Data

Schneider Electric's mål er at opnå Net Zero-status i 2050 gennem partnerskaber med forsyningskæden, materialer med lavere påvirkning og cirkularitet via vores igangværende kampagne "Use Better, Use Longer, Use Again" for at forlænge produkternes levetid og genbrugelighed.

[Forklaring af Environmental Data >](#)

[Sådan vurderer vi produktets bæredygtighed >](#)

Miljøfodaftryk

CO2-belastning (kg CO2 eq.) 1

Miljøoplysning [Miljøprofil for produkt](#)

Use Better

Materialer og emballage

Pakke med genbrugspap Yes

Emballage uden plast Yes

[EU RoHS-direktivet](#) Proaktiv overensstemmelse (produkt ikke omfattet af EU RoHS)

Reach-forordning [REACH-erklæring](#)

Use Again

Ompakning og genfremstilling

Cirkularitetsprofil [Oplysninger om udtjent udstyr](#)

Returnering No

Dimensions Drawings

Dimensions

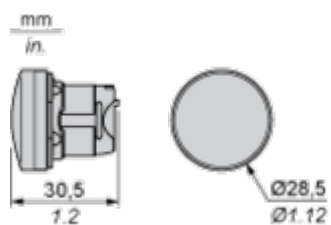

Mounting and Clearance

Panel Cut-out for Pushbuttons, Switches and Pilot Lights (Finished Holes, Ready for Installation)

Connection by Screw Clamp Terminals or Plug-in Connectors or on Printed Circuit Board



- (1) Diameter on finished panel or support
- (2) For selector switches and Emergency stop buttons, use of an anti-rotation plate type ZB5AZ902 is recommended.
- (3) Ø22.5 mm recommended ($\text{Ø}22.3_0^{+0.4}$) / Ø0.89 in. recommended ($\text{Ø}0.88_0^{+0.016}$)

Connections	a in mm	a in in.	b in mm	b in in.
By screw clamp terminals or plug-in connector	40	1.57	30	1.18
By Faston connectors	45	1.77	32	1.26
On printed circuit board	30	1.18	30	1.18

Detail of Lug Recess



- (1) Diameter on finished panel or support
- (2) For selector switches and Emergency stop buttons, use of an anti-rotation plate type ZB5AZ902 is recommended.
- (3) Ø22.5 mm recommended ($\text{Ø}22.3_0^{+0.4}$) / Ø0.89 in. recommended ($\text{Ø}0.88_0^{+0.016}$)

Pushbuttons, Switches and Pilot Lights for Printed Circuit Board Connection

Panel Cut-outs (Viewed from Installer's Side)

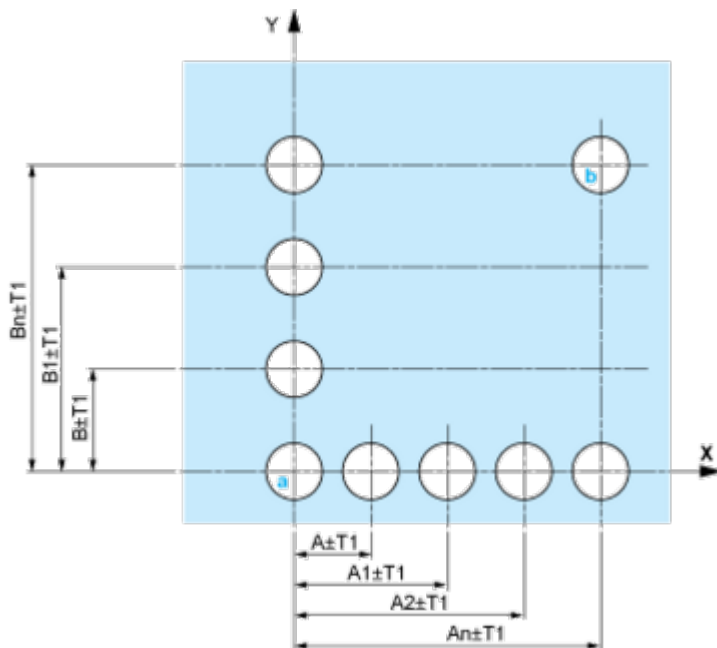

A: 30 mm min. / 1.18 in. min.

B: 40 mm min. / 1.57 in. min.

Printed Circuit Board Cut-outs (Viewed from Electrical Block Side)

Dimensions in mm

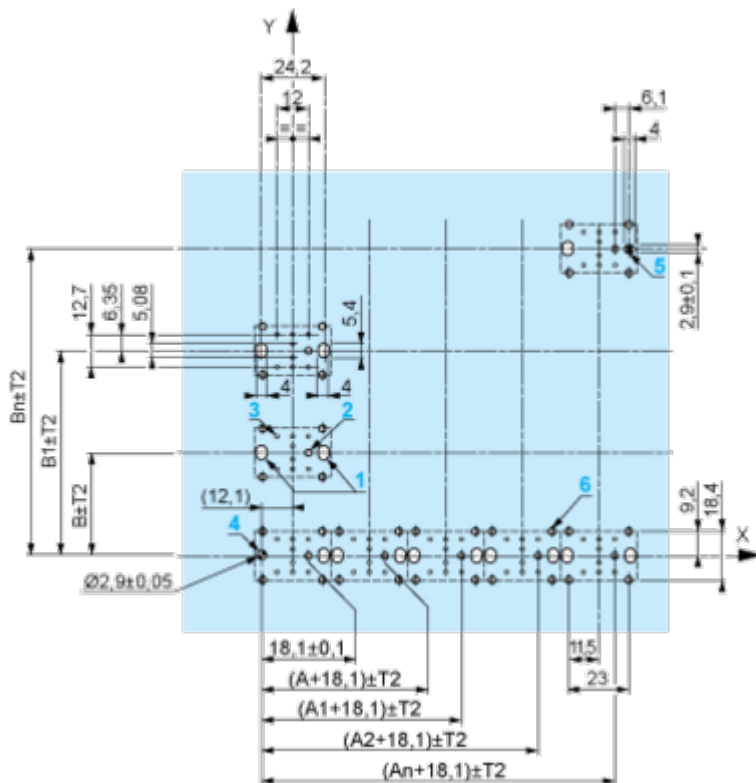

A: 30 mm min.

B: 40 mm min.

Dimensions in in.

- (1) Head ZB5AD•
- (2) Panel
- (2) Nut
- (4) Printed circuit board

Mounting of Adapter (Socket) ZBZ01•

- 1 2 elongated holes for ZBZ006 screw access
- 2 1 hole \varnothing 2.4 mm \pm 0.05 / 0.09 in. \pm 0.002 for centring adapter ZBZ01•
- 3 8 \times \varnothing 1.2 mm / 0.05 in. holes
- 4 1 hole \varnothing 2.9 mm \pm 0.05 / 0.11 in. \pm 0.002, for aligning the printed circuit board (with cut-out marked **a**)
- 5 1 elongated hole for aligning the printed circuit board (with cut-out marked **b**)
- 6 4 holes \varnothing 2.4 mm / 0.09 in. for clipping in adapter ZBZ01•

Dimensions An + 18.1 relate to the \varnothing 2.4 mm \pm 0.05 / 0.09 in. \pm 0.002 holes for centring adapter ZBZ01•.

Technical Description

Electrical Composition Corresponding to Codes P1, P3, PF1, PR1 and PF2

Light block



Electrical Composition Corresponding to Codes M6 and P2



Legend

Single contact



Double contact



Light block











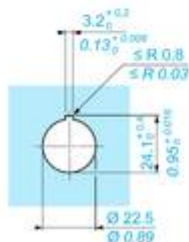
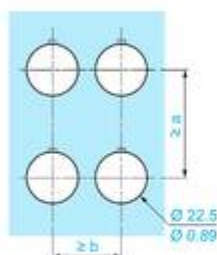
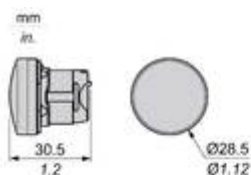



Possible location



Technical Illustration

Dimensions



		a (mm)	a (in.)	b (mm)	b (in.)
		40	1.57	30	1.18
ZBE.....	ZBV.....				
		45	1.77	32	1.26
ZBE.....3	ZBV.....3				
		40	1.57	30	1.18
ZBE.....4	ZBV.....4				
		50	1.97	30	1.18
ZBE.....5	ZBV.....5				
		40	1.57	30	1.18
ZBE.....9	ZBV.....9				
		40	1.57	30	1.18
ZBRT•	ZBRV1				

Offer Marketing Illustration

Product benefits / Features

The graphic features a green background with the title "Features" and subtitle "Harmony XB4/XB5 Illuminated functions". It contains four feature descriptions, each with an icon and a corresponding image of a switch component:

- NEW universal LED Block for all colors:** Represented by a square icon with a smaller square inside. The image shows a green switch with a green LED lens.
- Simple stock management:** Represented by a person icon. The image shows a black switch with a red LED lens.
- Improved installation time and easy selection:** Represented by a circular arrow icon. The image shows a yellow switch with a yellow LED lens.
- Improved color intensity and brightness:** Represented by a sun icon. The image shows a black switch with a red LED lens.

Offer Marketing Illustration

Product benefits / Features

Features Harmony XB5



- 

Quick and easy assembly and disassembly
- 

Excellent mechanical connection with operator head
- 

Various types of connection: screw clamp, connector, Faston connector, spring terminal, or printed circuit board
- 

Robustness to withstand harsh environments
- 

Large set of accessories to customize your panels

Offer Marketing Illustration

Product benefits / Features

Technical Benefits

Harmony XB5



Image of product / Alternate images

Alternative





