

Produktdatablad

Specifikationer



Harmony nødstopshoved i plast med Ø40 mm paddehoved i rød farve og træk for at frigøre

El-nr.:
7517903787

ZB5AT84

EAN-nr: 3389110907742

Egenskaber

Produktserie	Harmony XB5
Produkttype	Hoved til nødstop
Anvendelse	Nødstop
Enhedsforkortelse	ZB5
Materiale og farve på frontring	Mørkegrå plast
Hovedtype	Standard
Montagediameter	22 mm
Mindst mulige salgsantal	1
Form på hoved	Rundt
Betjeningsprofil	aktivering med mekanisk låsning
Nulstil	Tryk-træk
Betjeningsprofil	Rød Paddetryk Ø 40 mm, Uden mærkning
Konstruktion	Som løsdele

Produktinformationer

Bredde	40 mm
Højde	40 mm
Dybde	56 mm
Vægt	0,05 kg
Mekanisk holdbarhed	300000 kredsløb
Kanalnavn	XALD 1 montagehul XALK 1 montagehul
Kode for elektrisk sammensætning	C7 til <4 kontakter benytter enkelt blokke i Montering forfra C8 til <4 kontakter benytter enkelt og dobbelt blokke i Montering forfra C11 til <3 kontakter benytter enkelt blokke i Montering forfra C15 til <1 kontakter benytter enkelt blokke i Montering forfra SF1 til <3 kontakter benytter enkelt blokke i Montering forfra SR1 til <3 kontakter benytter enkelt blokke i Montering bagfra C10 til <4 kontakter benytter enkelt og dobbelt blokke i Montering forfra
Kompatibilitetskode	ZB5

Miljø

Beskyttelsesbehandling	TH
Omgivelsestemperatur ved opbevaring	-40...70 °C
Omgivelsestemperatur under drift	-40...70 °C

Overspændingskategori	Klasse II conforming to IEC 60536
IP kapslingsklasse	IP66 i henhold til IEC 60529 IP67 IP69 IP69K
NEMA kapslingsklasse	NEMA 13 NEMA 4X
Modstandsdygtighed overfor højtryksrensning	7000000 Pa ved 55 °C, distance : 0.1 m
IP kapslingsklasse	IK03 conforming to IEC 50102
Standarder	ISO 13850 IEC 60947-5-1 CSA C22.2 No 14 IEC 60364-5-53 JIS C8201-5-1 UL 508 IEC 60947-1 GB 14048.5 IEC 60947-5-4 IEC 60947-5-5 IEC 60204-1 JIS C8201-1
Produktcertificeringer	CSA DNV BV LROS (Lloyds register of shipping) UL listet
Vibrationsmodstand	5 gn (f= 2...500 Hz) conforming to IEC 60068-2-6
Modstandsdygtighed overfor stød	30 gn (varighed = 18 milisekund) til Halv sinusbølge acceleration i henhold til IEC 60068-2-27 50 gn (varighed = 11 milisekund) til Halv sinusbølge acceleration i henhold til IEC 60068-2-27

Forpakkingsinformation

Enhedstype af pakke 1	PCE
Antal enheder i pakke 1	1
Pakke 1 Højde	4,500 cm
Pakke 1 Længde	5,400 cm
Package 1 Length	8,800 cm
Pakke 1 Vægt	47,000 g
Enhedstype af pakke 2	S02
Antal enheder i pakke 2	42
Pakke 2 Højde	15,000 cm
Pakke 2 Bredde	30,000 cm
Pakke 2 Længde	40,000 cm
Pakke 2 Vægt	2,319 kg
Enhedstype af pakke 3	P06
Antal enheder i pakke 3	672
Pakke 3 Højde	75,000 cm
Pakke 3 Bredde	60,000 cm
Pakke 3 Længde	80,000 cm
Pakke 3 Vægt	49,380 kg

Logistik informationer

Oprindelsesland CZ

Garanti

Garanti 18 months

Environmental Data

Schneider Electric's mål er at opnå Net Zero-status i 2050 gennem partnerskaber med forsyningskæden, materialer med lavere påvirkning og cirkularitet via vores igangværende kampagne "Use Better, Use Longer, Use Again" for at forlænge produkternes levetid og genbrugelighed.

[Forklaring af Environmental Data >](#)

[Sådan vurderer vi produktets bæredygtighed >](#)

Miljøfodaftryk

CO2-belastning (kg CO2 eq.) 1

Miljøoplysning [Miljøprofil for produkt](#)

Use Better

Materialer og emballage

Pakke med genbrugspap Yes

Emballage uden plast Yes

[EU RoHS-direktivet](#)

Proaktiv overensstemmelse (produkt ikke omfattet af EU RoHS)

Reach-forordning

[REACH-erklæring](#)

Use Again

Ompakning og genfremstilling

Cirkularitetsprofil [Oplysninger om udtjent udstyr](#)

Returnering No

Dimensions Drawings

Dimensions

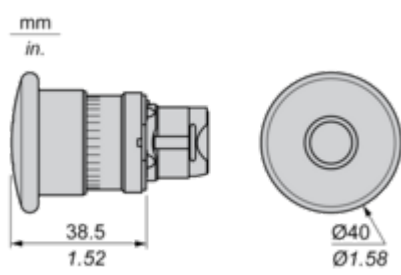

Mounting and Clearance

Panel Cut-out for Pushbuttons, Switches and Pilot Lights (Finished Holes, Ready for Installation)

Connection by Screw Clamp Terminals or Plug-in Connectors or on Printed Circuit Board

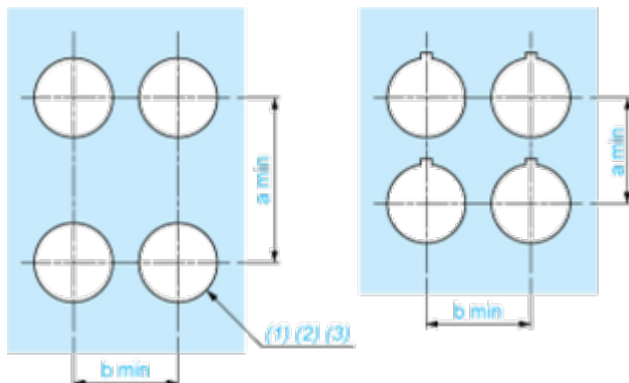

- (1) Diameter on finished panel or support
- (2) For selector switches and Emergency stop buttons, use of an anti-rotation plate type ZB5AZ902 is recommended.
- (3) Ø22.5 mm recommended ($\text{Ø}22.3_0^{+0.4}$) / Ø0.89 in. recommended ($\text{Ø}0.88_0^{+0.016}$)

Connections	a in mm	a in in.	b in mm	b in in.
By screw clamp terminals or plug-in connector	40	1.57	30	1.18
By Faston connectors	45	1.77	32	1.26
On printed circuit board	30	1.18	30	1.18

Detail of Lug Recess



- (1) Diameter on finished panel or support
- (2) For selector switches and Emergency stop buttons, use of an anti-rotation plate type ZB5AZ902 is recommended.
- (3) Ø22.5 mm recommended ($\text{Ø}22.3_0^{+0.4}$) / Ø0.89 in. recommended ($\text{Ø}0.88_0^{+0.016}$)

Pushbuttons, Switches and Pilot Lights for Printed Circuit Board Connection

Panel Cut-outs (Viewed from Installer's Side)

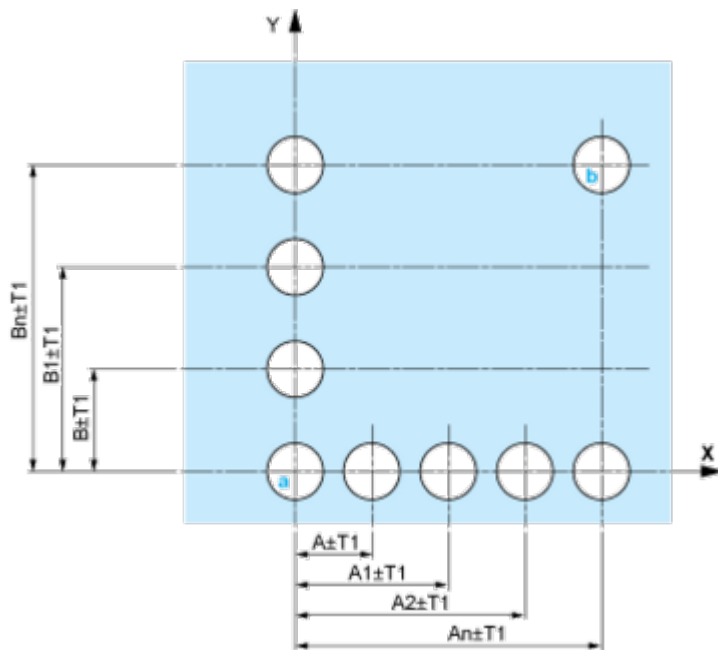

A: 30 mm min. / 1.18 in. min.
 B: 40 mm min. / 1.57 in. min.

Printed Circuit Board Cut-outs (Viewed from Electrical Block Side)

Dimensions in mm

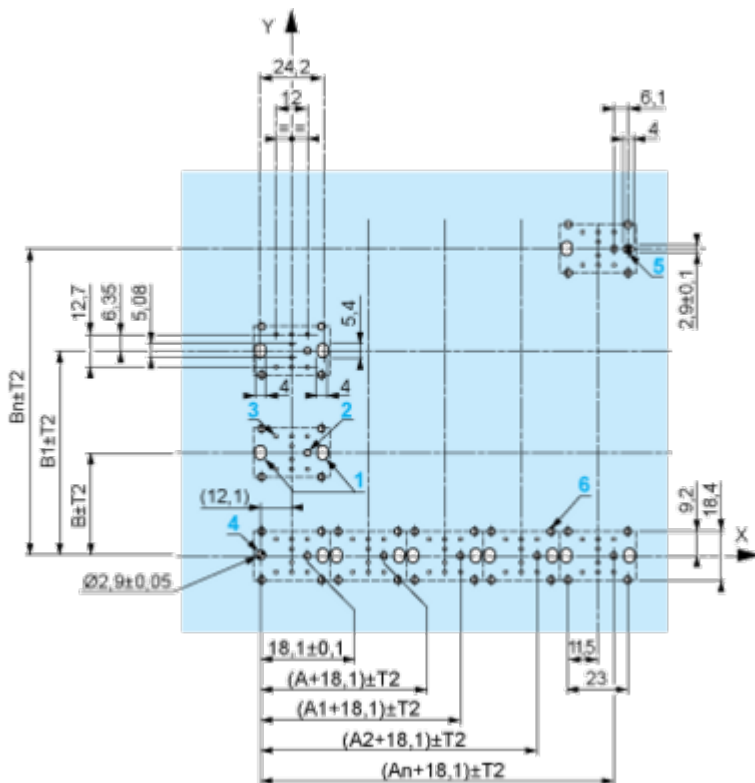

A: 30 mm min.
 B: 40 mm min.
 Dimensions in in.

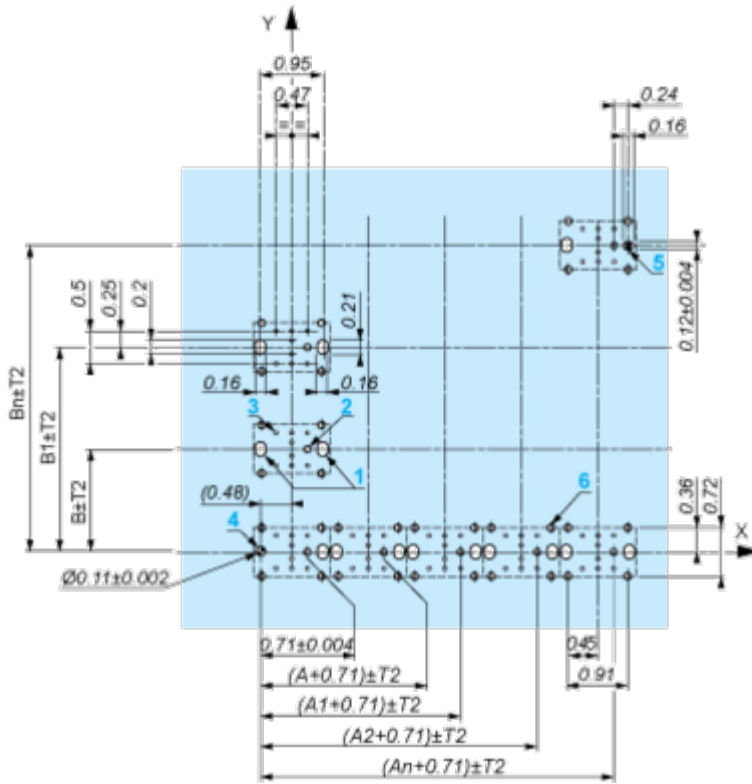

A: 1.18 in. min.
 B: 1.57 in. min.

General Tolerances of the Panel and Printed Circuit Board

The cumulative tolerance must not exceed 0.3 mm / 0.012 in.: T1 + T2 = 0.3 mm max.

Installation Precautions

- Minimum thickness of circuit board: 1.6 mm / 0.06 in.
- Cut-out diameter: 22.4 mm ± 0.1 / 0.88 in. ± 0.004
- Orientation of body/fixing collar ZB5AZ009: ± 2° 30' (excluding cut-outs marked a and b).
- Tightening torque of screws ZBZ006: 0.6 N.m (5.3 lbf.in) max.
- Allow for one ZB5AZ079 fixing collar/pillar and its fixing screws:
 - every 90 mm / 3.54 in. horizontally (X), and 120 mm / 4.72 in. vertically (Y).
 - with each selector switch head (ZB5AD*, ZB5AJ*, ZB5AG*).

The fixing centers marked a and b are diagonally opposed and must align with those marked 4 and 5.

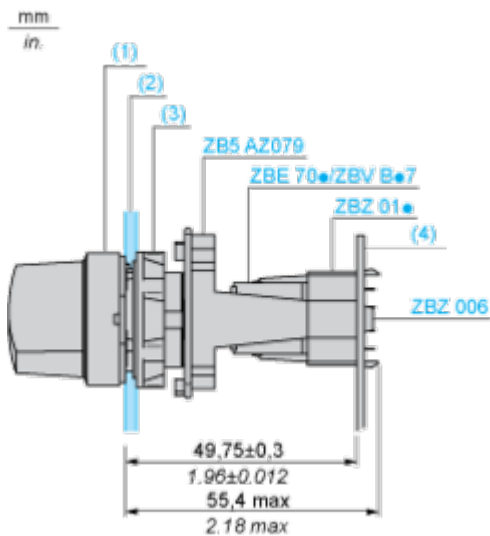

- (1) Head ZB5AD•
- (2) Panel
- (2) Nut
- (4) Printed circuit board

Mounting of Adapter (Socket) ZBZ01•

- 1 2 elongated holes for ZBZ006 screw access
- 2 1 hole \varnothing 2.4 mm \pm 0.05 / 0.09 in. \pm 0.002 for centring adapter ZBZ01•
- 3 8 \times \varnothing 1.2 mm / 0.05 in. holes
- 4 1 hole \varnothing 2.9 mm \pm 0.05 / 0.11 in. \pm 0.002, for aligning the printed circuit board (with cut-out marked **a**)
- 5 1 elongated hole for aligning the printed circuit board (with cut-out marked **b**)
- 6 4 holes \varnothing 2.4 mm / 0.09 in. for clipping in adapter ZBZ01•

Dimensions An + 18.1 relate to the \varnothing 2.4 mm \pm 0.05 / 0.09 in. \pm 0.002 holes for centring adapter ZBZ01•.

Technical Description

Electrical Composition Corresponding to Code C7



Electrical Compositions Corresponding to Code C8

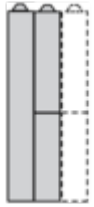

Electrical Compositions Corresponding to Code C10

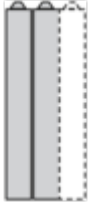

Electrical Composition Corresponding to Codes C9, C11, SF1 and SR1

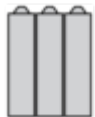

Electrical Composition Corresponding to Code C15

1 N/O

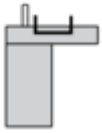

1 N/C



1 N/O + N/C or 1 N/O + N/O or 1 N/C + N/C

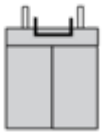

Legend

Single contact



Double contact



Light block



Possible location



Technical Illustration

Dimensions

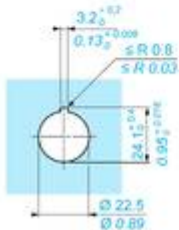
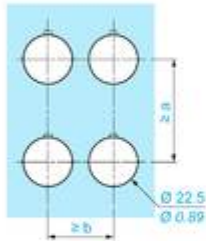
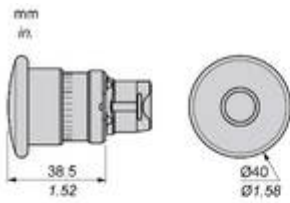

		a (mm)	a (in.)	b (mm)	b (in.)
	ZBE..... ZBV.....	40	1.57	30	1.18
	ZBE.....3 ZBV.....3	45	1.77	32	1.26
	ZBE.....4 ZBV.....4	40	1.57	30	1.18
	ZBE.....5 ZBV.....5	50	1.97	30	1.18
	ZBE.....9 ZBV.....9	40	1.57	30	1.18
	ZBRT... ZBRV1	40	1.57	30	1.18

Offer Marketing Illustration

Product benefits / Features

Technical Benefits

Harmony XB5 e-stop function

Fit to several customer functions needs: turn to release, push to release, key release

Guarantee of proper installation thanks to NC contact with monitoring function.

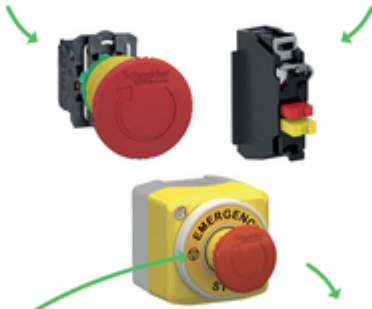

Designed as per international standards for high performance.

Fit for all machine sizes and environments:

- Small machines > 30 mm
- Standard machines > 40 mm
- Use of gloves > 60 mm

Offer Marketing Illustration

Product benefits / Features

Features

Harmony XB5 e-stop function



Wide modular range to suit machines and operator safety.



Ergonomic design for emergency actuation in several environments



Illuminated types to improve operator efficiency by reducing production downtime.



Large set of accessories: circular legends, illuminated legend rings, protective bellows for harsh environments and protective guards.



Designed to fit in a standard 22mm cut-out or Harmony XALK control station ensuring compatibility with pre-existing machinery



Image of product / Alternate images

Alternative

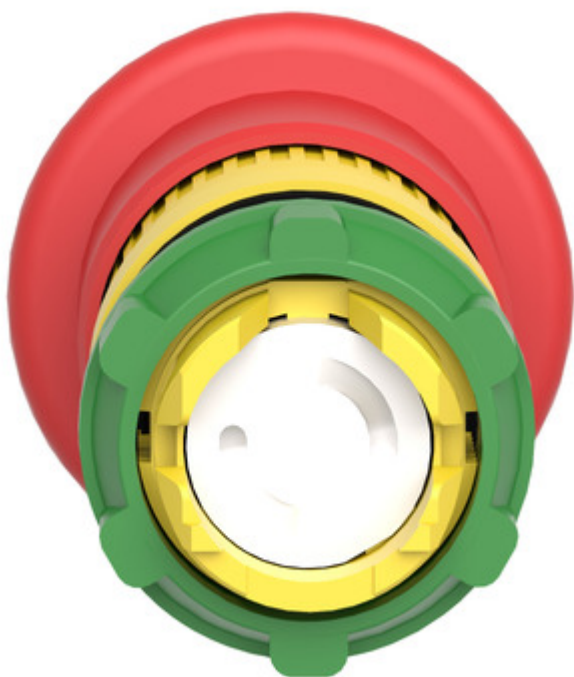





Image of product in real life situation

