

Produktdatablad

Specifikationer



Harmony nøglegreb i plast med 2 faste positioner og nøgle (Ronis 455) ud i V+H

El-nr.:
7517901365

ZB5AG4

EAN-nr: 3389110905823

Egenskaber

Produktserie	Harmony XB5
Produkttype	Hoved til nøgleafbryder
Enhedsforkortelse	ZB5
Materiale og farve på frontring	Mørkegrå plast
Montagediameter	22 mm
Hovedtype	Standard
Mindst mulige salgsantal	1
Form på hoved	Rundt
Betjeningsprofil	faste positioner
Betjeningsprofil	Sort Nøgleanbryder
Antal positioner	2 positioner 90°
Nøgletype	Key 455
Position for nøgleudtræk	I alle positioner

Produktinformationer

Bredde	29 mm
Højde	29 mm
Dybde	72 mm
Vægt	0,057 kg
Mekanisk holdbarhed	1000000 kredsløb
Kanalnavn	XALD 1...5 montagehuller XALK 2...5 montagehuller
Kode for elektrisk sammensætning	C4 til <6 kontakter benytter enkelt og dobbelt blokke i Montering forfra C5 til <5 kontakter benytter enkelt blokke i Montering forfra C6 til <5 kontakter benytter enkelt og dobbelt blokke i Montering forfra C7 til <4 kontakter benytter enkelt blokke i Montering forfra C8 til <4 kontakter benytter enkelt og dobbelt blokke i Montering forfra C11 til <3 kontakter benytter enkelt blokke i Montering forfra C3 til <6 kontakter benytter enkelt blokke i Montering forfra SF1 til <3 kontakter benytter enkelt blokke i Montering forfra SR1 til <3 kontakter benytter enkelt blokke i Montering bagfra C15 til <1 kontakter benytter enkelt blokke i Montering forfra
Konstruktion	Som løsdele

Miljø

Beskyttelsesbehandling	TH
------------------------	----

Omgivelsestemperatur ved opbevaring	-40...70 °C
Omgivelsestemperatur under drift	-40...70 °C
Overspændingskategori	Klasse II conforming to IEC 60536
IP kapslingsklasse	IP66 i henhold til IEC 60529 IP67 IP69 IP69K
NEMA kapslingsklasse	NEMA 13 NEMA 4X
Modstandsdygtighed overfor højtryksrensning	7000000 Pa ved 55 °C, distance : 0.1 m
IP kapslingsklasse	IK06 conforming to IEC 50102
Standarder	UL 508 IEC 60947-5-1 IEC 60947-5-4 JIS C8201-5-1 CSA C22.2 No 14 IEC 60947-1 JIS C8201-1
Produktcertificeringer	DNV CSA BV LROS (Lloyds register of shipping) UL listet
Vibrationsmodstand	5 gn (f= 2...500 Hz) conforming to IEC 60068-2-6
Modstandsdygtighed overfor stød	30 gn (varighed = 18 milisekund) til Halv sinusbølge acceleration i henhold til IEC 60068-2-27 50 gn (varighed = 11 milisekund) til Halv sinusbølge acceleration i henhold til IEC 60068-2-27

Forpakkingsinformation

Enhedstype af pakke 1	PCE
Antal enheder i pakke 1	1
Pakke 1 Højde	9,000 cm
Pakke 1 Længde	5,200 cm
Package 1 Length	3,300 cm
Pakke 1 Vægt	66,000 g
Enhedstype af pakke 2	BB1
Antal enheder i pakke 2	5
Pakke 2 Højde	9,000 cm
Pakke 2 Bredde	3,300 cm
Pakke 2 Længde	26,500 cm
Pakke 2 Vægt	335,000 g
Enhedstype af pakke 3	S03
Antal enheder i pakke 3	150
Pakke 3 Højde	30,000 cm
Pakke 3 Bredde	30,000 cm
Pakke 3 Længde	40,000 cm
Pakke 3 Vægt	10,330 kg

Logistik informationer

Oprindelsesland FR

Garanti

Garanti 18 months

Environmental Data

Schneider Electric's mål er at opnå Net Zero-status i 2050 gennem partnerskaber med forsyningskæden, materialer med lavere påvirkning og cirkularitet via vores igangværende kampagne "Use Better, Use Longer, Use Again" for at forlænge produkternes levetid og genbrugelighed.

[Forklaring af Environmental Data](#) >

[Sådan vurderer vi produktets bæredygtighed](#) >

Miljøaftryk

CO2-belastning (kg CO2 eq.) 1

Miljøoplysning [Miljøprofil for produkt](#)

Use Better

Materialer og emballage

Pakke med genbrugspap No

Emballage uden plast No

[EU RoHS-direktivet](#) Proaktiv overensstemmelse (produkt ikke omfattet af EU RoHS)

SCIP-nummer 6fb3a517-3ce5-4a60-a6e9-428d970f8e28

Reach-forordning [REACH-erklæring](#)

Use Again

Ompakning og genfremstilling

Cirkularitetsprofil [Oplysninger om udtjent udstyr](#)

Returnering No

Dimensions Drawings

Dimensions

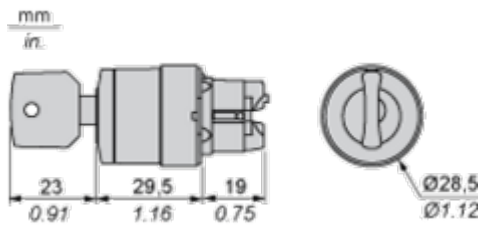

Mounting and Clearance

Panel Cut-out for Pushbuttons, Switches and Pilot Lights (Finished Holes, Ready for Installation)

Connection by Screw Clamp Terminals or Plug-in Connectors or on Printed Circuit Board



- (1) Diameter on finished panel or support
- (2) For selector switches and Emergency stop buttons, use of an anti-rotation plate type ZB5AZ902 is recommended.
- (3) $\varnothing 22.5$ mm recommended ($\varnothing 22.3_0^{+0.4}$) / $\varnothing 0.89$ in. recommended ($\varnothing 0.88_0^{+0.016}$)

Connections	a in mm	a in in.	b in mm	b in in.
By screw clamp terminals or plug-in connector	40	1.57	30	1.18
By Faston connectors	45	1.77	32	1.26
On printed circuit board	30	1.18	30	1.18

Detail of Lug Recess



- (1) Diameter on finished panel or support
- (2) For selector switches and Emergency stop buttons, use of an anti-rotation plate type ZB5AZ902 is recommended.
- (3) $\varnothing 22.5$ mm recommended ($\varnothing 22.3_0^{+0.4}$) / $\varnothing 0.89$ in. recommended ($\varnothing 0.88_0^{+0.016}$)



A: 1.18 in. min.
 B: 1.57 in. min.

General Tolerances of the Panel and Printed Circuit Board

The cumulative tolerance must not exceed 0.3 mm / 0.012 in.: T1 + T2 = 0.3 mm max.

Installation Precautions

- Minimum thickness of circuit board: 1.6 mm / 0.06 in.
- Cut-out diameter: 22.4 mm ± 0.1 / 0.88 in. ± 0.004
- Orientation of body/fixing collar ZB5AZ009: ± 2° 30' (excluding cut-outs marked a and b).
- Tightening torque of screws ZBZ006: 0.6 N.m (5.3 lbf.in) max.
- Allow for one ZB5AZ079 fixing collar/pillar and its fixing screws:
 - every 90 mm / 3.54 in. horizontally (X), and 120 mm / 4.72 in. vertically (Y).
 - with each selector switch head (ZB5AD*, ZB5AJ*, ZB5AG*).

The fixing centers marked a and b are diagonally opposed and must align with those marked 4 and 5.

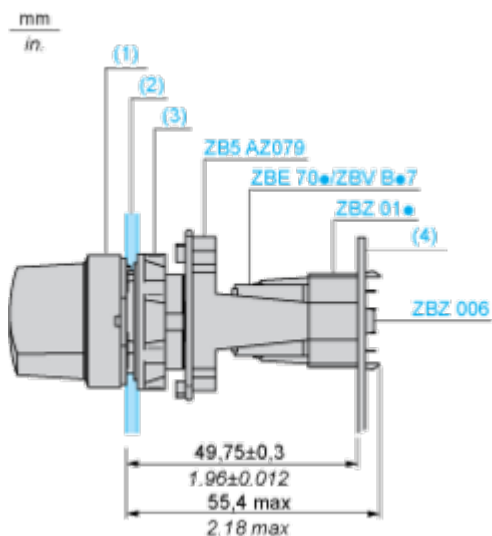

- (1) Head ZB5AD•
- (2) Panel
- (2) Nut
- (4) Printed circuit board

Mounting of Adapter (Socket) ZBZ01•

- 1 2 elongated holes for ZBZ006 screw access
- 2 1 hole \varnothing 2.4 mm \pm 0.05 / 0.09 in. \pm 0.002 for centring adapter ZBZ01•
- 3 8 \times \varnothing 1.2 mm / 0.05 in. holes
- 4 1 hole \varnothing 2.9 mm \pm 0.05 / 0.11 in. \pm 0.002, for aligning the printed circuit board (with cut-out marked **a**)
- 5 1 elongated hole for aligning the printed circuit board (with cut-out marked **b**)
- 6 4 holes \varnothing 2.4 mm / 0.09 in. for clipping in adapter ZBZ01•

Dimensions An + 18.1 relate to the \varnothing 2.4 mm \pm 0.05 / 0.09 in. \pm 0.002 holes for centring adapter ZBZ01•.

Technical Description

Electrical Composition Corresponding to Code C4



Electrical Composition Corresponding to Code C5



Electrical Composition Corresponding to Code C6



Electrical Composition Corresponding to Code C7

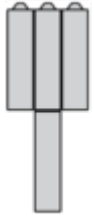

Electrical Composition Corresponding to Code C8



Electrical Composition Corresponding to Code C3



Electrical Composition Corresponding to Codes C9, C11, SF1 and SR1

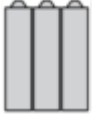

Legend

Single contact



Double contact



Light block



Possible location



Sequence of Contacts Fitted to 2-position Selector Switch Body

Position 315°



Push	Position	Top			
		Bottom			
	Location		Left	Centre	Right
	State		0	0	0
	Contacts		N/O	open	open
		N/C	closed	closed	closed

Position 45°



Push	Position	Top			
		Bottom			
	Location		Left	Centre	Right
	State		1	1	1
Contacts		N/O	closed	closed	closed
		N/C	open	open	open

Technical Illustration

Dimensions

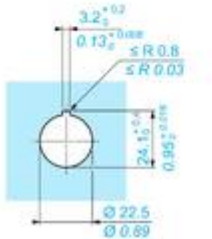
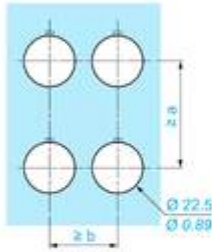
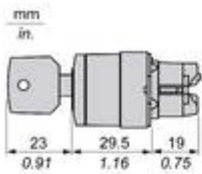

		a (mm)	a (in.)	b (mm)	b (in.)
		40	1.57	30	1.18
ZBE●●●●	ZBV●●●●				
		45	1.77	32	1.26
ZBE●●●●3	ZBV●●●●3				
		40	1.57	30	1.18
ZBE●●●●4	ZBV●●●●4				
		50	1.97	30	1.18
ZBE●●●●5	ZBV●●●●5				
		40	1.57	30	1.18
ZBE●●●●9	ZBV●●●●9				
		40	1.57	30	1.18
ZBRT●	ZBRV1				

Offer Marketing Illustration

Product benefits / Features

Features Harmony XB5



- 

Quick and easy assembly and disassembly
- 

Excellent mechanical connection with operator head
- 

Various types of connection: screw clamp, connector, Faston connector, spring terminal, or printed circuit board
- 

Large set of accessories to customize your panels
- 

Robustness to withstand harsh environments

Offer Marketing Illustration

Product benefits / Features

Technical Benefits

Harmony XB5



Image of product / Alternate images

Alternative





