

# Produktdatablad

Specifikationer



## Harmony nøglegreb i metal med 3 positioner og fjeder-retur til midt og nøgle (Ronis 455) ud i M

El-nr.:

7517803890

ZB4BG7

EAN-nr: 3389110889284

## Egenskaber

Produktserie	Harmony XB4
Produkttype	Hoved til nøgleafbryder
Enhedsforkortelse	ZB4
Materiale og farve på frontring	Forkromet metal
Montagediameter	22 mm
Hovedtype	Standard
Mindst mulige salgsantal	1
Form på hoved	Rundt
Returnering	Til midt
Betjeningsprofil	Sort Nøgleanbryder
Antal positioner	3 positioner +/- 45°
Nøgletype	Key 455
Position for nøgleudtræk	I midterposition

## Produktinformationer

Bredde	29 mm
Højde	29 mm
Dybde	72 mm
Vægt	0,098 kg
Modstandsdygtighed overfor højtryksrensning	7000000 Pa ved 55 °C, distance : 0.1 m
Mekanisk holdbarhed	1000000 kredsløb
Kode for elektrisk sammensætning	C3 til <6 kontakter benytter enkelt blokke i Montering forfra C4 til <6 kontakter benytter enkelt og dobbelt blokke i Montering forfra C5 til <5 kontakter benytter enkelt blokke i Montering forfra C6 til <5 kontakter benytter enkelt og dobbelt blokke i Montering forfra C7 til <4 kontakter benytter enkelt blokke i Montering forfra C8 til <4 kontakter benytter enkelt og dobbelt blokke i Montering forfra C11 til <3 kontakter benytter enkelt blokke i Montering forfra
Konstruktion	Som løsdele

## Miljø

Beskyttelsesbehandling	TH
Omgivelsestemperatur ved opbevaring	-40...70 °C
Omgivelsestemperatur under drift	-40...70 °C

<b>Overspændingskategori</b>	Klasse I conforming to IEC 60536
<b>IP kapslingsklasse</b>	IP66 i henhold til IEC 60529 IP67 IP69 IP69K
<b>NEMA kapslingsklasse</b>	NEMA 13 NEMA 4X
<b>IP kapslingsklasse</b>	IK06 med dæksel for nøglehul ZBGP conforming to IEC 50102
<b>Standarder</b>	EN/IEC 60947-5-5 EN/IEC 60947-1 UL 508 CSA C22.2 No 14 EN/IEC 60947-5-4 EN/IEC 60947-5-1 GB 14048.5
<b>Produktcertificeringer</b>	CSA DNV BV LROS (Lloyds register of shipping) UL listet
<b>Vibrationsmodstand</b>	5 gn (f= 2...500 Hz) conforming to IEC 60068-2-6
<b>Modstandsdygtighed overfor stød</b>	30 gn (varighed = 18 milisekund) til Halv sinusbølge acceleration i henhold til IEC 60068-2-27 50 gn (varighed = 11 milisekund) til Halv sinusbølge acceleration i henhold til IEC 60068-2-27

## Forpakkingsinformation

<b>Enhedstype af pakke 1</b>	PCE
<b>Antal enheder i pakke 1</b>	1
<b>Pakke 1 Højde</b>	3,600 cm
<b>Pakke 1 Længde</b>	5,500 cm
<b>Package 1 Length</b>	9,100 cm
<b>Pakke 1 Vægt</b>	103,000 g
<b>Enhedstype af pakke 2</b>	S03
<b>Antal enheder i pakke 2</b>	100
<b>Pakke 2 Højde</b>	30,000 cm
<b>Pakke 2 Bredde</b>	30,000 cm
<b>Pakke 2 Længde</b>	40,000 cm
<b>Pakke 2 Vægt</b>	10,826 kg
<b>Enhedstype af pakke 3</b>	P06
<b>Antal enheder i pakke 3</b>	800
<b>Pakke 3 Højde</b>	75,000 cm
<b>Pakke 3 Bredde</b>	60,000 cm
<b>Pakke 3 Længde</b>	80,000 cm
<b>Pakke 3 Vægt</b>	97,404 kg

## Logistik informationer

<b>Oprindelsesland</b>	FR
------------------------	----

## Garanti

---

Garanti

18 months

## Environmental Data

Schneider Electric's mål er at opnå Net Zero-status i 2050 gennem partnerskaber med forsyningskæden, materialer med lavere påvirkning og cirkularitet via vores igangværende kampagne "Use Better, Use Longer, Use Again" for at forlænge produkternes levetid og genbrugelighed.

[Forklaring af Environmental Data >](#)

[Sådan vurderer vi produktets bæredygtighed >](#)

### Miljøfodaftryk

CO2-belastning (kg CO2 eq.) 1

Miljøoplysning [Miljøprofil for produkt](#)

### Use Better

#### Materialer og emballage

Pakke med genbrugspap No

Emballage uden plast No

[EU RoHS-direktivet](#) Proaktiv overensstemmelse (produkt ikke omfattet af EU RoHS)

SCIP-nummer 6fb3a517-3ce5-4a60-a6e9-428d970f8e28

Reach-forordning [REACH-erklæring](#)

### Use Again

#### Ompakning og genfremstilling

Cirkularitetsprofil [Oplysninger om udtjent udstyr](#)

Returnering No

Dimensions Drawings

Dimensions

---

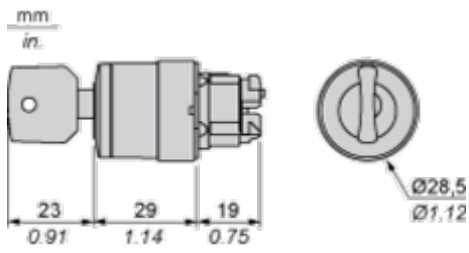

Mounting and Clearance

Panel Cut-out for Pushbuttons, Switches and Pilot Lights (Finished Holes, Ready for Installation)

Connection by Screw Clamp Terminals or Plug-in Connectors or on Printed Circuit Board	Connection by Faston Connectors
	
<p>(1) Diameter on finished panel or support                  (2) 40 mm min. / 1.57 in. min.                  (3) 30 mm min. / 1.18 in. min.                  (4) <math>\varnothing 22.5 \text{ mm} / 0.89 \text{ in. recommended } (\varnothing 22.3 \text{ mm }_0^{+0.4} / 0.88 \text{ in. }_0^{+0.016})</math>                  (5) 45 mm min. / 1.78 in. min.                  (6) 32 mm min. / 1.26 in. min.</p>	

Pushbuttons, Switches and Pilot Lights for Printed Circuit Board Connection

Panel Cut-outs (Viewed from Installer's Side)

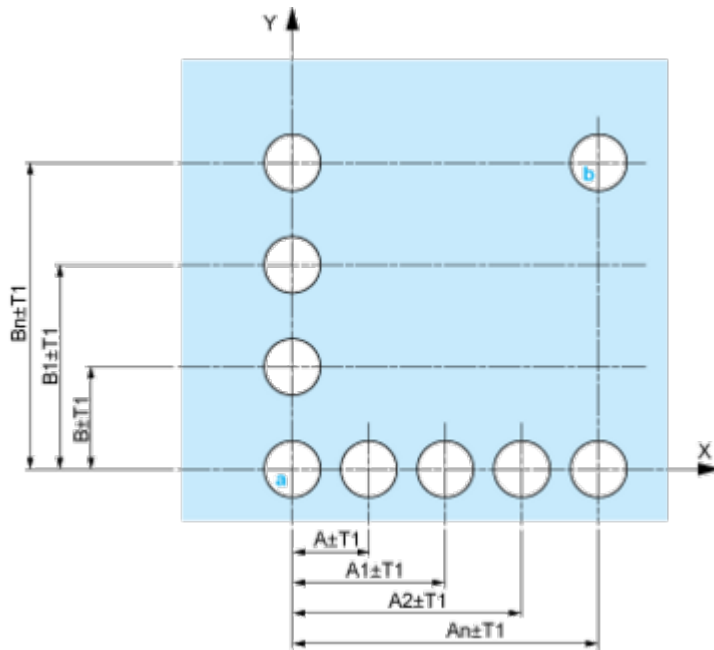

A: 30 mm min. / 1.18 in. min.

B: 40 mm min. / 1.57 in. min.

Printed Circuit Board Cut-outs (Viewed from Electrical Block Side)

Dimensions in mm

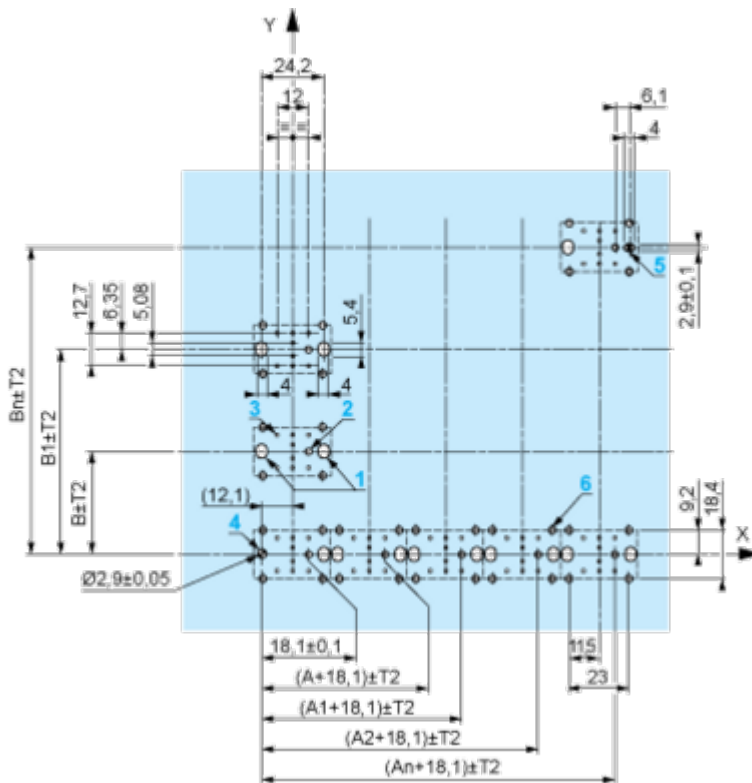

A: 30 mm min.

B: 40 mm min.

Dimensions in in.



A: 1.18 in. min.  
 B: 1.57 in. min.

**General Tolerances of the Panel and Printed Circuit Board**

The cumulative tolerance must not exceed 0.3 mm / 0.012 in: T1 + T2 = 0.3 mm max.

**Installation Precautions**

- Minimum thickness of circuit board: 1.6 mm / 0.06 in.
- Cut-out diameter: 22.4 mm ± 0.1 / 0.88 in. ± 0.004
- Orientation of body/fixing collar ZB4 BZ009: ± 2° 30' (excluding cut-outs marked a and b).
- Tightening torque of screws ZBZ 006: 0.6 N.m (5.3 lbf.in) max.
- Allow for one ZB4 BZ079 fixing collar/pillar and its fixing screws:
  - every 90 mm / 3.54 in. horizontally (X), and 120 mm / 4.72 in. vertically (Y).
  - with each selector switch head (ZB4 BD\*, ZB4 BJ\*, ZB4 BG\*).

The fixing centers marked a and b are diagonally opposed and must align with those marked 4 and 5.



(1) Panel

(2) Printed circuit board

**Mounting of Adapter (Socket) ZBZ 01•**

- 1 2 elongated holes for ZBZ 006 screw access
- 2 1 hole  $\varnothing 2.4 \text{ mm} \pm 0.05 / 0.09 \text{ in.} \pm 0.002$  for centring adapter ZBZ 01•
- 3  $8 \times \varnothing 1.2 \text{ mm} / 0.05 \text{ in.}$  holes
- 4 1 hole  $\varnothing 2.9 \text{ mm} \pm 0.05 / 0.11 \text{ in.} \pm 0.002$ , for aligning the printed circuit board (with cut-out marked a)
- 5 1 elongated hole for aligning the printed circuit board (with cut-out marked b)
- 6 4 holes  $\varnothing 2.4 \text{ mm} / 0.09 \text{ in.}$  for clipping in adapter ZBZ 01•

Dimensions An + 18.1 relate to the  $\varnothing 2.4 \text{ mm} \pm 0.05 / 0.09 \text{ in.} \pm 0.002$  holes for centring adapter ZBZ 01•.

## Technical Description

### Electrical Composition Corresponding to Code C3

---



Electrical Composition Corresponding to Code C4

---



Electrical Composition Corresponding to Code C5

---

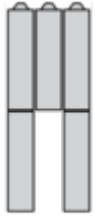

Electrical Composition Corresponding to Code C6

---



Electrical Composition Corresponding to Code C7

---

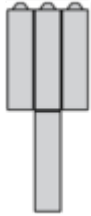

Electrical Composition Corresponding to Code C8

---

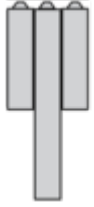

Electrical Composition Corresponding to Codes C9, C11, SF1 and SR1

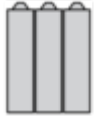

## Legend

---

Single contact



Double contact



Light block



Possible location



Sequence of Contacts Fitted to 3-position Selector Switch Body

Position 315°



Push	Position	Top			
		Bottom			
	Location		Left	Centre	Right
	State		1	1	0
Contacts	N/O		closed	closed	open
	N/C		open	open	closed

Position 0°



Push	Position	Top			
		Bottom			
	Location		Left	Centre	Right
	State		0	0	0
Contacts	N/O		open	open	open
	N/C		closed	closed	closed

Position 45°



<b>Push</b>	Position	Top			
		Bottom			
	Location		Left	Centre	Right
	State		0	1	1
<b>Contacts</b>	N/O		open	closed	closed
	N/C		closed	open	open

Technical Illustration

Dimensions

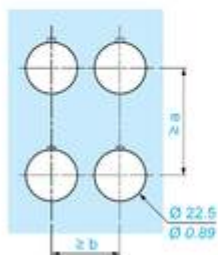
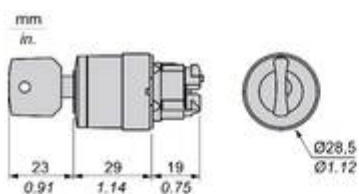

		a (mm)	a (in.)	b (mm)	b (in.)
		40	1.57	30	1.18
ZBE.....	ZBV.....				
		45	1.77	32	1.26
ZBE.....3	ZBV.....3				
		40	1.57	30	1.18
ZBE.....4	ZBV.....4				
		50	1.97	30	1.18
ZBE.....5	ZBV.....5				
		40	1.57	30	1.18
ZBE.....9	ZBV.....9				
		40	1.57	30	1.18
ZBRT•	ZBRV1				

Offer Marketing Illustration

Product benefits / Features

---

## Technical Benefits

### Harmony XB4

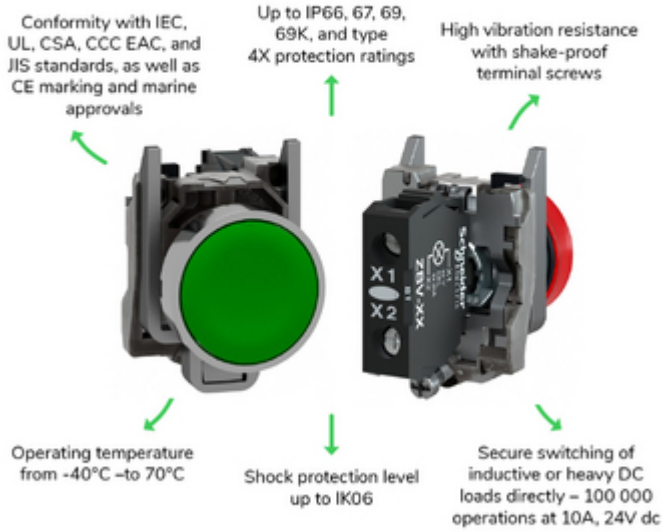

Offer Marketing Illustration

Product benefits / Features

---

**Features**  
Harmony XB4





-  Quick and easy assembly and disassembly
-  Excellent mechanical connection with operator head
-  Various types of connection: screw clamp, connector, Faston connector, spring terminal, or printed circuit board
-  Large set of accessories to customize your panels
-  Robustness to withstand harsh environments

Image of product / Alternate images

Alternative

---

