

# Produktdatablad

Specifikationer



## Harmony nødstopshoved i plast med Ø40 mm padderhoved i rød farve og nøgle (Ronis 455) for at frigøre

El-nr.:  
7517901297

ZB5AS944

EAN-nr: 3389110906967

## Egenskaber

Produktserie	Harmony XB5
Produkttype	Hoved til nødstop
Anvendelse	Nødstop
Enhedsforkortelse	ZB5
Materiale og farve på frontring	Mørkegrå plast
Hovedtype	Standard
Montagediameter	22 mm
Mindst mulige salgsantal	1
Form på hoved	Rundt
Betjeningsprofil	aktivering med mekanisk låsning
Nulstil	Frigørelse med nøgle
Betjeningsprofil	Rød Paddetryk Ø 40 mm, Uden mærkning
Nøgletype	Key 455
Position for nøgleudtræk	I midterposition
Konstruktion	Som løsdele

## Produktinformationer

Bredde	40 mm
Højde	40 mm
Dybde	79 mm
Vægt	0,071 kg
Mekanisk holdbarhed	300000 kredsløb
Kanalnavn	XALD 1 montagehul XALK 1 montagehul
Kode for elektrisk sammensætning	C7 til <4 kontakter benytter enkelt blokke i Montering forfra C8 til <4 kontakter benytter enkelt og dobbelt blokke i Montering forfra C11 til <3 kontakter benytter enkelt blokke i Montering forfra C15 til <1 kontakter benytter enkelt blokke i Montering forfra SF1 til <3 kontakter benytter enkelt blokke i Montering forfra SR1 til <3 kontakter benytter enkelt blokke i Montering bagfra C10 til <4 kontakter benytter enkelt og dobbelt blokke i Montering forfra
Kompatibilitetskode	ZB5

## Miljø

Beskyttelsesbehandling	TH
------------------------	----

Omgivelsestemperatur ved opbevaring	-40...70 °C
Omgivelsestemperatur under drift	-40...70 °C
Overspændingskategori	Klasse II conforming to IEC 60536
IP kapslingsklasse	IP66 i henhold til IEC 60529 IP67 IP69 IP69K
NEMA kapslingsklasse	NEMA 13 NEMA 4X
Modstandsdygtighed overfor højtryksrensning	7000000 Pa ved 55 °C, distance : 0.1 m
IP kapslingsklasse	IK03 conforming to IEC 50102
Standarder	IEC 60364-5-53 JIS C8201-5-1 IEC 60947-1 GB 14048.5 IEC 60947-5-5 IEC 60204-1 UL 508 CSA C22.2 No 14 IEC 60947-5-1 ISO 13850 IEC 60947-5-4 JIS C8201-1
Produktcertificeringer	CSA DNV BV LROS (Lloyds register of shipping) UL listet
Vibrationsmodstand	5 gn (f= 2...500 Hz) conforming to IEC 60068-2-6
Modstandsdygtighed overfor stød	30 gn (varighed = 18 milisekund) til Halv sinusbølge acceleration i henhold til IEC 60068-2-27 50 gn (varighed = 11 milisekund) til Halv sinusbølge acceleration i henhold til IEC 60068-2-27

## Forpakkingsinformation

Enhedstype af pakke 1	PCE
Antal enheder i pakke 1	1
Pakke 1 Højde	8,800 cm
Pakke 1 Længde	5,300 cm
Package 1 Length	4,300 cm
Pakke 1 Vægt	69,000 g
Enhedstype af pakke 2	S03
Antal enheder i pakke 2	100
Pakke 2 Højde	30,000 cm
Pakke 2 Bredde	30,000 cm
Pakke 2 Længde	40,000 cm
Pakke 2 Vægt	7,372 kg

## Logistik informationer

Oprindelsesland	CZ
-----------------	----

## Garanti

---

Garanti

18 months

## Environmental Data

Schneider Electric's mål er at opnå Net Zero-status i 2050 gennem partnerskaber med forsyningskæden, materialer med lavere påvirkning og cirkularitet via vores igangværende kampagne "Use Better, Use Longer, Use Again" for at forlænge produkternes levetid og genbrugelighed.

[Forklaring af Environmental Data >](#)

[Sådan vurderer vi produktets bæredygtighed >](#)

### Miljøaftryk

CO2-belastning (kg CO2 eq.)	1
-----------------------------	---

### Use Better

#### Materialer og emballage

Pakke med genbrugspap	No
-----------------------	----

Emballage uden plast	No
----------------------	----

<a href="#">EU RoHS-direktivet</a>	Proaktiv overensstemmelse (produkt ikke omfattet af EU RoHS)
------------------------------------	--

SCIP-nummer	6fb3a517-3ce5-4a60-a6e9-428d970f8e28
-------------	--------------------------------------

Reach-forordning	<a href="#">REACH-erklæring</a>
------------------	---------------------------------

### Use Again

#### Ompakning og genfremstilling

Returnering	No
-------------	----

Dimensions Drawings

Dimensions

---

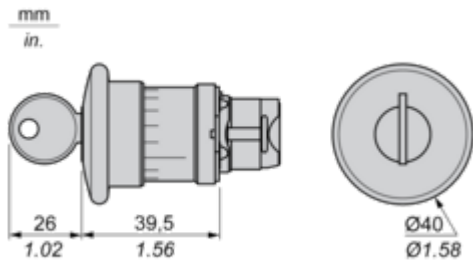

Mounting and Clearance

**Panel Cut-out for Pushbuttons, Switches and Pilot Lights (Finished Holes, Ready for Installation)**

**Connection by Screw Clamp Terminals or Plug-in Connectors or on Printed Circuit Board**



- (1) Diameter on finished panel or support
- (2) For selector switches and Emergency stop buttons, use of an anti-rotation plate type ZB5AZ902 is recommended.
- (3) Ø22.5 mm recommended ( $\text{Ø}22.3_0^{+0.4}$ ) / Ø0.89 in. recommended ( $\text{Ø}0.88_0^{+0.016}$ )

Connections	a in mm	a in in.	b in mm	b in in.
By screw clamp terminals or plug-in connector	40	1.57	30	1.18
By Faston connectors	45	1.77	32	1.26
On printed circuit board	30	1.18	30	1.18

**Detail of Lug Recess**



- (1) Diameter on finished panel or support
- (2) For selector switches and Emergency stop buttons, use of an anti-rotation plate type ZB5AZ902 is recommended.
- (3) Ø22.5 mm recommended ( $\text{Ø}22.3_0^{+0.4}$ ) / Ø0.89 in. recommended ( $\text{Ø}0.88_0^{+0.016}$ )

Pushbuttons, Switches and Pilot Lights for Printed Circuit Board Connection

Panel Cut-outs (Viewed from Installer's Side)

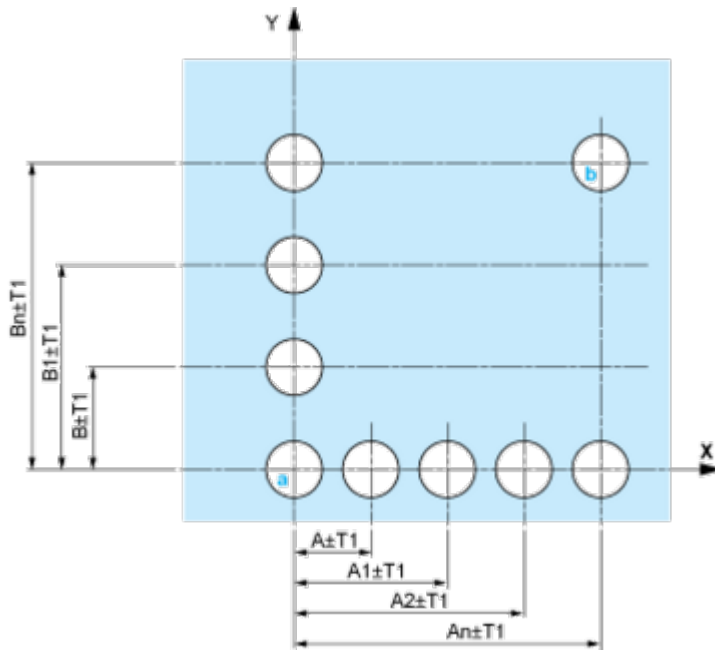

A: 30 mm min. / 1.18 in. min.

B: 40 mm min. / 1.57 in. min.

Printed Circuit Board Cut-outs (Viewed from Electrical Block Side)

Dimensions in mm

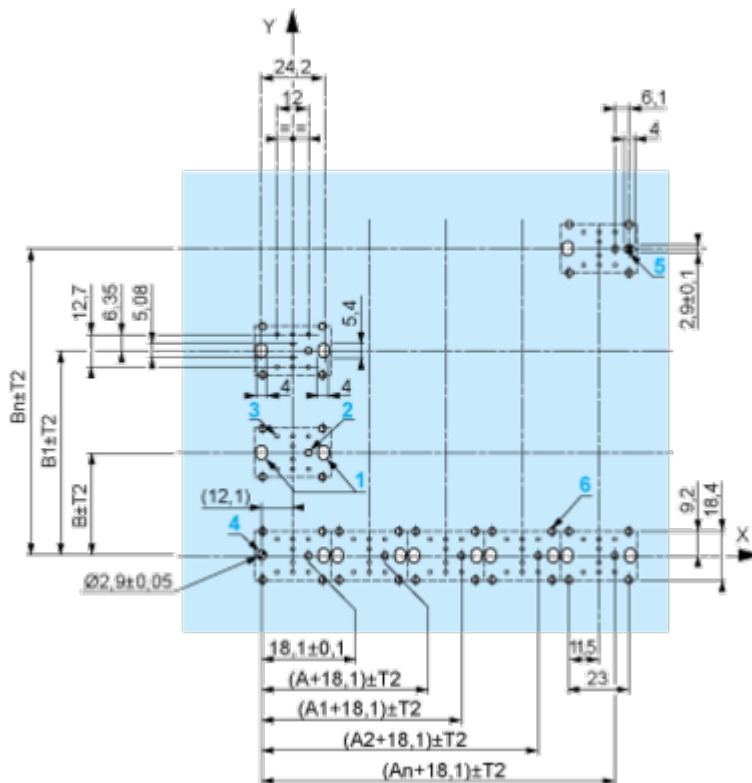

A: 30 mm min.

B: 40 mm min.

Dimensions in in.



- (1) Head ZB5AD•
- (2) Panel
- (2) Nut
- (4) Printed circuit board

## Mounting of Adapter (Socket) ZBZ01•

- 1 2 elongated holes for ZBZ006 screw access
- 2 1 hole  $\varnothing$  2.4 mm  $\pm$  0.05 / 0.09 in.  $\pm$  0.002 for centring adapter ZBZ01•
- 3 8  $\times$   $\varnothing$  1.2 mm / 0.05 in. holes
- 4 1 hole  $\varnothing$  2.9 mm  $\pm$  0.05 / 0.11 in.  $\pm$  0.002, for aligning the printed circuit board (with cut-out marked **a**)
- 5 1 elongated hole for aligning the printed circuit board (with cut-out marked **b**)
- 6 4 holes  $\varnothing$  2.4 mm / 0.09 in. for clipping in adapter ZBZ01•

Dimensions An + 18.1 relate to the  $\varnothing$  2.4 mm  $\pm$  0.05 / 0.09 in.  $\pm$  0.002 holes for centring adapter ZBZ01•.

Technical Description

Electrical Composition Corresponding to Code C7

---



Electrical Compositions Corresponding to Code C8

---

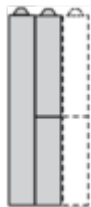

Electrical Compositions Corresponding to Code C10

---

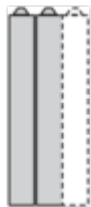

Electrical Composition Corresponding to Codes C9, C11, SF1 and SR1

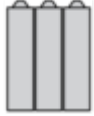

Electrical Composition Corresponding to Code C15

---

1 N/O

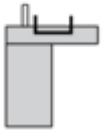

1 N/C



1 N/O + N/C or 1 N/O + N/O or 1 N/C + N/C

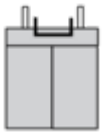

**Legend**

---

Single contact



Double contact



Light block



Possible location



Technical Illustration

Dimensions

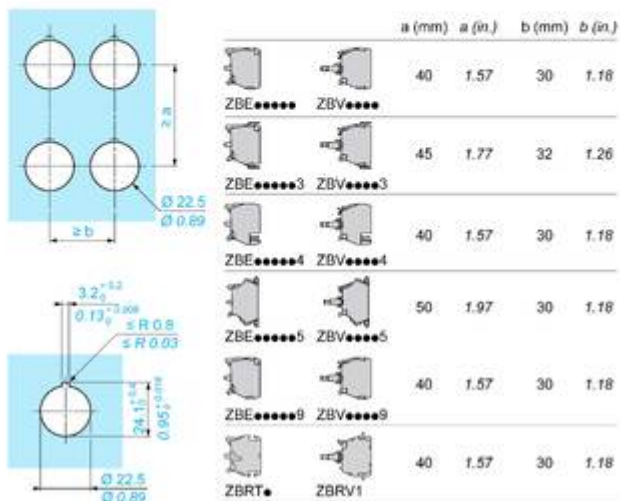
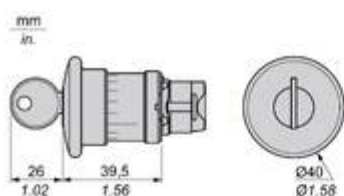

Offer Marketing Illustration

Product benefits / Features

---

## Technical Benefits

Harmony XB5 e-stop function

Fit to several customer functions needs: turn to release, push to release, key release

Guarantee of proper installation thanks to NC contact with monitoring function.

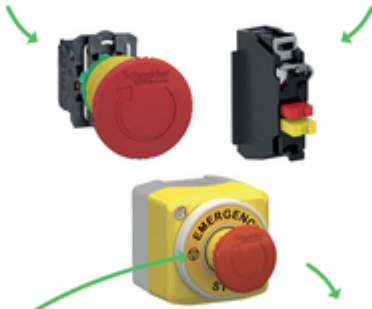

Designed as per international standards for high performance.

Fit for all machine sizes and environments:

- Small machines > 30 mm
- Standard machines > 40 mm
- Use of gloves > 60 mm

Offer Marketing Illustration

Product benefits / Features

---

### Features

#### Harmony XB5 e-stop function



 Wide modular range to suit machines and operator safety.

 Ergonomic design for emergency actuation in several environments

 Designed to fit in a standard 22mm cut-out or Harmony XALK control station ensuring compatibility with pre-existing machinery

 Illuminated types to improve operator efficiency by reducing production downtime.

 Large set of accessories: circular legends, illuminated legend rings, protective bellows for harsh environments and protective guards.

Image of product / Alternate images

Alternative

---

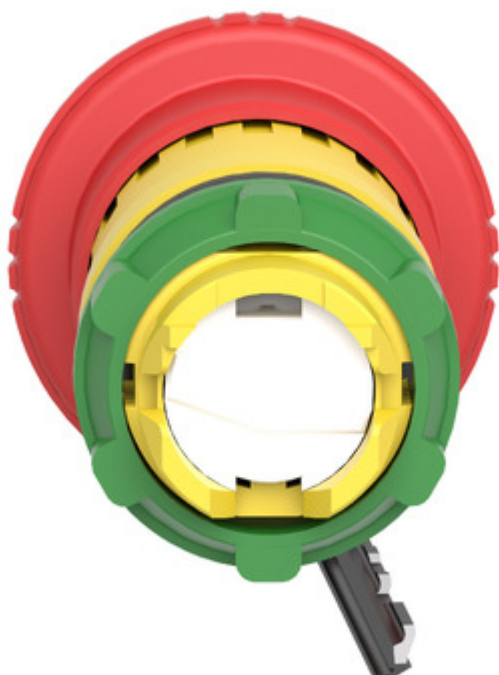
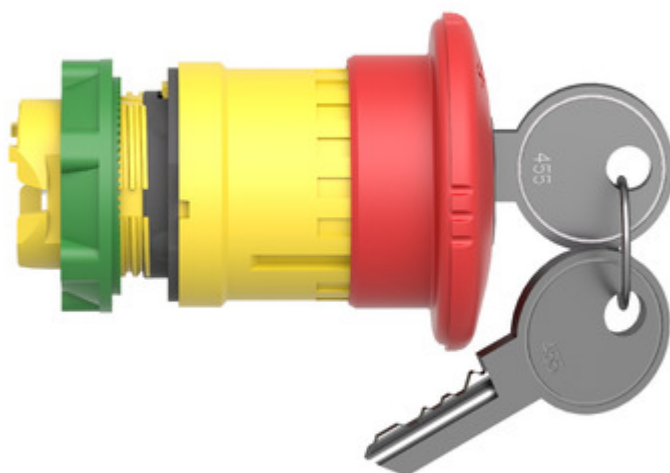

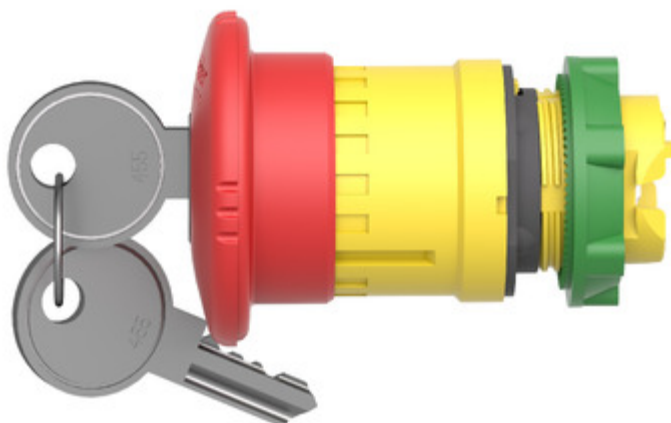



Image of product in real life situation

