

Produktdatablad

Specifikationer



Harmony signallampe komplet med LED i blå farve og 24VAC/DC forsyning

El-nr.:

7517800961

XB4BVB6

Vigtig meddelelse: A change in appearance may be noted on the product but does not affect its use in terms of function and safety. This makes it compatible with our Universal LED blocks
EAN-nr: 3389110119077

Egenskaber

Produktserie	Harmony XB4
Produkttype	Signallampe
Enhedsforkortelse	XB4
Materiale og farve på frontring	Forkromet metal
Materiale på fastgørelseskrop	Zamak
Montagediameter	22,5 mm
Hovedtype	Standard
Mindst mulige salgsantal	1
Form på hoved	Rundt
Farve på trykflade eller linse	Blå
Yderligere egenskaber	Med almindelig linse
Lyskilde	Universal LED
Fatning	Integreret LED
Farve på lyskilde	Blå
Nominel forsyningsspænding [Us]	24 V AC/DC 50/60 Hz

Produktinformationer

Højde	47 mm
bredde	30 mm
Dybde	54 mm
Klemmenavn ISO n°1	(X1-X2)PL
Vægt	0,08 kg
Modstandsdygtighed overfor højtryksrensning	7000000 Pa ved 55 °C, distance : 0.1 m
Tilslutningklemmer	Skrukeklemmer, = 2 x 1.5 mm² Med kabeltulle i henhold til IEC 60947-1 Skrukeklemmer, 1 x 0.22...2 x 2.5 mm² Uden kabeltulle i henhold til IEC 60947-1
Isolationsspænding [Ui]	250 V (forureningsgrad 3) i henhold til IEC 60947-1
Impulsmodstandsspænding [Uimp]	4 kV i henhold til IEC 60947-1
Signaltyper	Fast
Strømforbrug	18 mA
Levetid	100000 time Ved nominel spænding og 25 °C

Modstand mod fysiske stød	1 kV i henhold til IEC 61000-4-5
Konstruktion	Komplet enhed
Grænse for forsyningsspænding	19,2...30 V DC 21,6...26,4 V AC

Miljø

Beskyttelsesbehandling	TH
Omgivelsestemperatur ved opbevaring	-40...70 °C
Omgivelsestemperatur under drift	-40...70 °C
Beskyttelsesklasse	Klasse I i henhold til IEC 60536
IP kapslingsklasse	IP66 i henhold til IEC 60529 IP67 IP69 IP69K
NEMA kapslingsklasse	NEMA 13 NEMA 4X
IP kapslingsklasse	IK06 conforming to IEC 50102
Standarder	IEC 60947-5-4 JIS C8201-5-1 IEC 60947-1 IEC 60947-5-5 CSA C22.2 No 14 UL 508 IEC 60947-5-1 JIS C8201-1
Produktcertificeringer	UL listet CSA
Vibrationsmodstand	5 gn (f= 12...500 Hz) conforming to IEC 60068-2-6
Modstandsdygtighed overfor stød	30 gn (varighed = 18 milisekund) til Halv sinusbølge acceleration i henhold til IEC 60068-2-27 50 gn (varighed = 11 milisekund) til Halv sinusbølge acceleration i henhold til IEC 60068-2-27
Modstandsdygtighed overfor transienter	2 kV i henhold til IEC 61000-4-4
Modstandsdygtighed overfor elektromagnetiske felter	10 V/m i henhold til IEC 61000-4-3
Modstandsdygtighed overfor statisk elektricitet	6 kV Ved kontakt (på metaldele) i henhold til IEC 61000-4-2 8 kV I fri luft (i isolerende dele) i henhold til IEC 61000-4-2
Elektromagnetisk stråling	Klasse B i henhold til IEC 55011

Forpakkingsinformation

Enhedstype af pakke 1	PCE
Antal enheder i pakke 1	1
Pakke 1 Højde	8,800 cm
Pakke 1 Længde	3,400 cm
Package 1 Length	5,400 cm
Pakke 1 Vægt	79,000 g
Enhedstype af pakke 2	S03
Antal enheder i pakke 2	150
Pakke 2 Højde	30,000 cm
Pakke 2 Bredde	30,000 cm

Pakke 2 Længde	40,000 cm
Pakke 2 Vægt	12,180 kg
Enhedstype af pakke 3	P06
Antal enheder i pakke 3	1200
Pakke 3 Højde	75,000 cm
Pakke 3 Bredde	60,000 cm
Pakke 3 Længde	80,000 cm
Pakke 3 Vægt	110,204 kg

Logistik informationer

Oprindelsesland	FR
-----------------	----

Garanti

Garanti	18 months
---------	-----------

Environmental Data

Schneider Electric's mål er at opnå Net Zero-status i 2050 gennem partnerskaber med forsyningskæden, materialer med lavere påvirkning og cirkularitet via vores igangværende kampagne "Use Better, Use Longer, Use Again" for at forlænge produkternes levetid og genbrugelighed.

[Forklaring af Environmental Data >](#)

[Sådan vurderer vi produktets bæredygtighed >](#)

Miljøfodaftryk

CO2-belastning (kg CO2 eq.) 1

Miljøoplysning [Miljøprofil for produkt](#)

Use Better

Materialer og emballage

Pakke med genbrugspap Yes

Emballage uden plast Yes

[EU RoHS-direktivet](#)

Proaktiv overensstemmelse (produkt ikke omfattet af EU RoHS)

SCIP-nummer 3d14fd98-3859-4733-a5ee-a3016769973c

Reach-forordning [REACH-erklæring](#)

Use Again

Ompakning og genfremstilling

Cirkularitetsprofil [Oplysninger om udtjent udstyr](#)

Returnering No

WEEE

 Produktet skal bortskaffes på EU's markeder efter en specifik affaldsindsamling og må aldrig ende i skraldespande

Dimensions Drawings

Dimensions

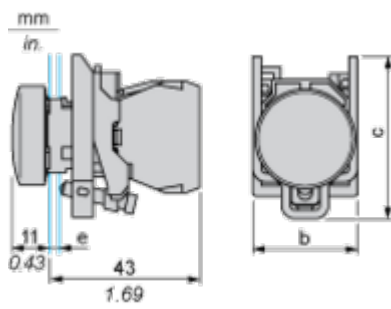

e : clamping thickness: 1 to 6 mm / 0.04 to 0.24 in.

b : 30 mm / 1.18 in.

c : 46.5 mm / 1.83 in.

Mounting and Clearance

Panel Cut-out for Pushbuttons, Switches and Pilot Lights (Finished Holes, Ready for Installation)

Connection by Screw Clamp Terminals or Plug-in Connectors or on Printed Circuit Board	Connection by Faston Connectors
	
<p>(1) Diameter on finished panel or support (2) 40 mm min. / 1.57 in. min. (3) 30 mm min. / 1.18 in. min. (4) $\varnothing 22.5 \text{ mm} / 0.89 \text{ in.}$ recommended ($\varnothing 22.3 \text{ mm}_0^{+0.4} / 0.88 \text{ in.}_0^{+0.016}$) (5) 45 mm min. / 1.78 in. min. (6) 32 mm min. / 1.26 in. min.</p>	

Technical Illustration

Dimensions

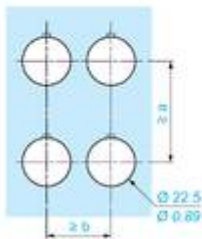
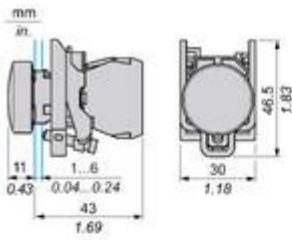

		a (mm)	a (in.)	b (mm)	b (in.)
		40	1.57	30	1.18
ZBE.....	ZBV.....				
		45	1.77	32	1.26
ZBE.....3	ZBV.....3				
		40	1.57	30	1.18
ZBE.....4	ZBV.....4				
		50	1.97	30	1.18
ZBE.....5	ZBV.....5				
		40	1.57	30	1.18
ZBE.....9	ZBV.....9				
		40	1.57	30	1.18
ZBRT•	ZBRV1				

Offer Marketing Illustration

Product benefits / Features

Features
Harmony XB4/XB5 Illuminated functions

NEW universal LED Block for all colors

Simple stock management

Improved installation time and easy selection

Improved color intensity and brightness

The image features a green background with the title 'Features' and subtitle 'Harmony XB4/XB5 Illuminated functions'. It displays four key benefits, each with a circular icon and a corresponding photograph of the product. The benefits are: 1) 'NEW universal LED Block for all colors' with a square icon containing a square; 2) 'Simple stock management' with a person icon; 3) 'Improved installation time and easy selection' with a circular arrow icon; and 4) 'Improved color intensity and brightness' with a sun icon. The product images show various colored buttons (green, red, yellow) and their internal LED components.

Offer Marketing Illustration

Product benefits / Features

Technical Benefits

Harmony XB4

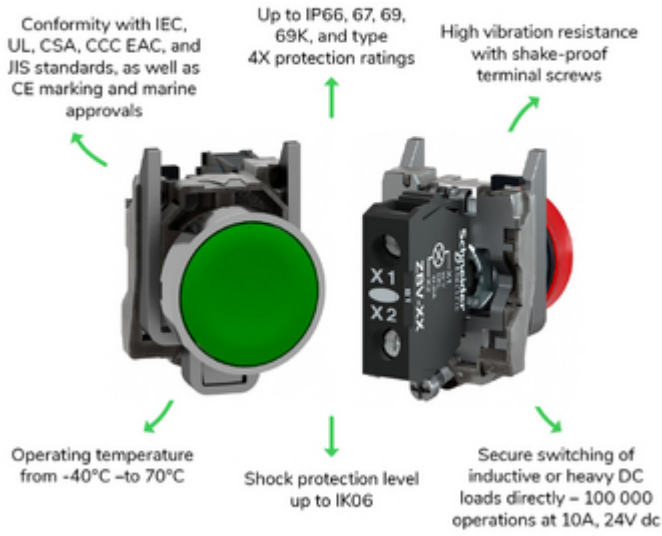

Offer Marketing Illustration

Product benefits / Features

Features
Harmony XB4





-  Quick and easy assembly and disassembly
-  Excellent mechanical connection with operator head
-  Various types of connection: screw clamp, connector, Faston connector, spring terminal, or printed circuit board
-  Large set of accessories to customize your panels
-  Robustness to withstand harsh environments

Image of product / Alternate images

Alternative

