

# Produktdatablad

Specifikationer



## Harmony drejeregreb i plast for LED med 2 faste positioner i rød farve

El-nr.:

7517906292

ZB5AK1243

**Vigtig meddelelse: A change in appearance may be noted on the product but does not affect its use in terms of function and safety.**

**This makes it compatible with our Universal LED blocks**

**EAN-nr: 3389110906073**

## Egenskaber

Produktserie	Harmony XB5
Produkttype	Hoved til drejefafbryder med LED
Produktet passer med	Universal LED
Enhedsforkortelse	ZB5
Materiale og farve på frontring	Mørkegrå plast
Montagediameter	22 mm
Hovedtype	Standard
Mindst mulige salgsantal	1
Form på hoved	Rundt
Betjeningsprofil	faste positioner
Betjeningsprofil	Rød Kort drejeregreb
Antal positioner	2 positioner 90°

## Produktinformationer

Bredde	29 mm
Højde	29 mm
Dybde	43 mm
Vægt	0,016 kg
Mekanisk holdbarhed	1000000 kredsløb
Kanalnavn	XALD 1...5 montagehuller XALK 2...5 montagehuller
Kode for elektrisk sammensætning	M3 til <4 kontakter benytter enkelt blokke i Montering forfra med integreret LED M6 til <2 kontakter benytter enkelt blokke i Montering forfra med integreret LED og transformere M10 til <2 kontakter benytter enkelt blokke i Montering forfra med integreret LED MF1 til <2 kontakter benytter enkelt blokke i Montering forfra med integreret LED MR1 til <2 kontakter benytter enkelt blokke i Montering bagfra med integreret LED M4 til <4 kontakter benytter enkelt og dobbelt blokke i Montering forfra med integreret LED
Konstruktion	Som løsdele

## Miljø

Beskyttelsesbehandling	TH
Omgivelsestemperatur ved opbevaring	-40...70 °C
Omgivelsestemperatur under drift	-40...70 °C

<b>Overspændingskategori</b>	Klasse II conforming to IEC 60536
<b>IP kapslingsklasse</b>	IP66 i henhold til IEC 60529 IP67 IP69 IP69K
<b>NEMA kapslingsklasse</b>	NEMA 13 NEMA 4X
<b>Modstandsdygtighed overfor højtryksrensning</b>	7000000 Pa ved 55 °C, distance : 0.1 m
<b>IP kapslingsklasse</b>	IK04 conforming to IEC 50102
<b>Standarder</b>	EN/IEC 60947-5-5 UL 508 EN/IEC 60947-5-4 EN/IEC 60947-1 CSA C22.2 No 14 JIS C8201-5-1 EN/IEC 60947-5-1 JIS C8201-1
<b>Produktcertificeringer</b>	CSA DNV BV LROS (Lloyds register of shipping) UL listet
<b>Vibrationsmodstand</b>	5 gn (f= 2...500 Hz) conforming to IEC 60068-2-6
<b>Modstandsdygtighed overfor stød</b>	30 gn (varighed = 18 milisekund) til Halv sinusbølge acceleration i henhold til IEC 60068-2-27 50 gn (varighed = 11 milisekund) til Halv sinusbølge acceleration i henhold til IEC 60068-2-27

## Forpakkingsinformation

<b>Enhedstype af pakke 1</b>	PCE
<b>Antal enheder i pakke 1</b>	1
<b>Pakke 1 Højde</b>	5,500 cm
<b>Pakke 1 Længde</b>	5,200 cm
<b>Package 1 Length</b>	3,300 cm
<b>Pakke 1 Vægt</b>	24,000 g
<b>Enhedstype af pakke 2</b>	S02
<b>Antal enheder i pakke 2</b>	100
<b>Pakke 2 Højde</b>	15,000 cm
<b>Pakke 2 Bredde</b>	30,000 cm
<b>Pakke 2 Længde</b>	40,000 cm
<b>Pakke 2 Vægt</b>	2,600 kg

## Logistik informationer

<b>Oprindelsesland</b>	FR
------------------------	----

## Garanti

<b>Garanti</b>	18 months
----------------	-----------

## Environmental Data

Schneider Electric's mål er at opnå Net Zero-status i 2050 gennem partnerskaber med forsyningskæden, materialer med lavere påvirkning og cirkularitet via vores igangværende kampagne "Use Better, Use Longer, Use Again" for at forlænge produkternes levetid og genbrugelighed.

[Forklaring af Environmental Data >](#)

[Sådan vurderer vi produktets bæredygtighed >](#)

### Miljøfodaftryk

CO2-belastning (kg CO2 eq.) 1

Miljøoplysning [Miljøprofil for produkt](#)

### Use Better

#### Materialer og emballage

Pakke med genbrugspap No

Emballage uden plast No

[EU RoHS-direktivet](#)

Proaktiv overensstemmelse (produkt ikke omfattet af EU RoHS)

Reach-forordning

[REACH-erklæring](#)

### Use Again

#### Ompakning og genfremstilling

Cirkularitetsprofil [Oplysninger om udtjent udstyr](#)

Returnering No

Dimensions Drawings

Dimensions

---

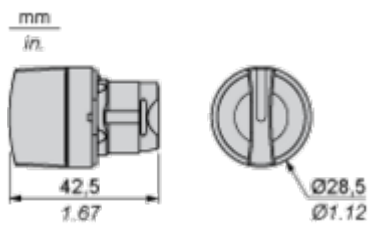

Mounting and Clearance

Panel Cut-out for Pushbuttons, Switches and Pilot Lights (Finished Holes, Ready for Installation)

Connection by Screw Clamp Terminals or Plug-in Connectors or on Printed Circuit Board



- (1) Diameter on finished panel or support
- (2) For selector switches and Emergency stop buttons, use of an anti-rotation plate type ZB5AZ902 is recommended.
- (3) Ø22.5 mm recommended ( $\text{Ø}22.3_0^{+0.4}$ ) / Ø0.89 in. recommended ( $\text{Ø}0.88_0^{+0.016}$ )

Connections	a in mm	a in in.	b in mm	b in in.
By screw clamp terminals or plug-in connector	40	1.57	30	1.18
By Faston connectors	45	1.77	32	1.26
On printed circuit board	30	1.18	30	1.18

Detail of Lug Recess



- (1) Diameter on finished panel or support
- (2) For selector switches and Emergency stop buttons, use of an anti-rotation plate type ZB5AZ902 is recommended.
- (3) Ø22.5 mm recommended ( $\text{Ø}22.3_0^{+0.4}$ ) / Ø0.89 in. recommended ( $\text{Ø}0.88_0^{+0.016}$ )

Pushbuttons, Switches and Pilot Lights for Printed Circuit Board Connection

Panel Cut-outs (Viewed from Installer's Side)

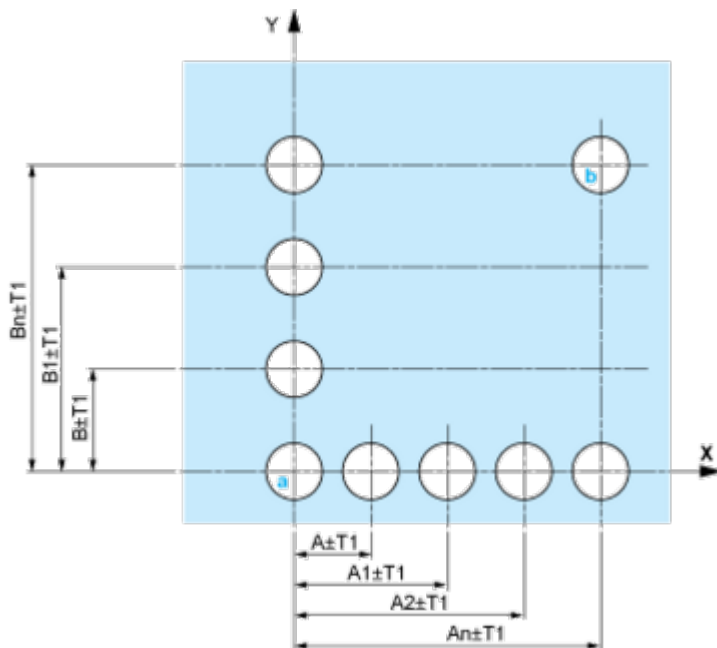

A: 30 mm min. / 1.18 in. min.

B: 40 mm min. / 1.57 in. min.

Printed Circuit Board Cut-outs (Viewed from Electrical Block Side)

Dimensions in mm

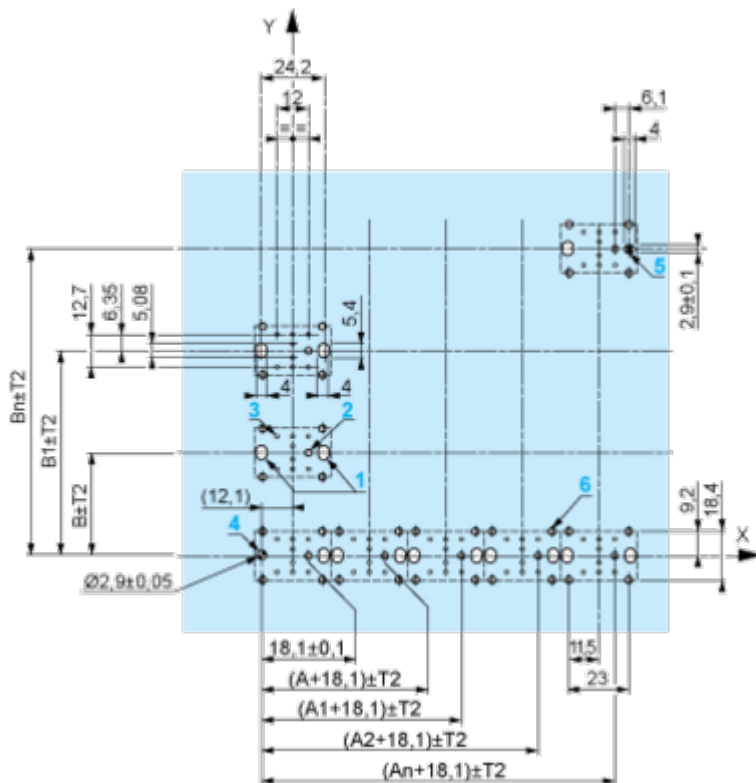

A: 30 mm min.

B: 40 mm min.

Dimensions in in.



- (1) Head ZB5AD•
- (2) Panel
- (2) Nut
- (4) Printed circuit board

## Mounting of Adapter (Socket) ZBZ01•

- 1 2 elongated holes for ZBZ006 screw access
- 2 1 hole  $\varnothing$  2.4 mm  $\pm$  0.05 / 0.09 in.  $\pm$  0.002 for centring adapter ZBZ01•
- 3 8  $\times$   $\varnothing$  1.2 mm / 0.05 in. holes
- 4 1 hole  $\varnothing$  2.9 mm  $\pm$  0.05 / 0.11 in.  $\pm$  0.002, for aligning the printed circuit board (with cut-out marked **a**)
- 5 1 elongated hole for aligning the printed circuit board (with cut-out marked **b**)
- 6 4 holes  $\varnothing$  2.4 mm / 0.09 in. for clipping in adapter ZBZ01•

Dimensions An + 18.1 relate to the  $\varnothing$  2.4 mm  $\pm$  0.05 / 0.09 in.  $\pm$  0.002 holes for centring adapter ZBZ01•.

Technical Description

Electrical Composition Corresponding to Code M3

---

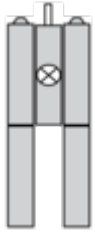

Electrical Composition Corresponding to Code M4

---



Electrical Composition Corresponding to Codes M6 and P2

---

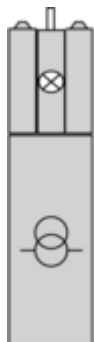

Electrical Composition Corresponding to Codes M5, M10, MF1, MR1 and MF2



**Legend**

---

Single contact



Double contact



Light block



Possible location



Sequence of Contacts Fitted to 2-position Selector Switch Body

Position 315°



Push	Position	Top			
		Bottom			
	Location		Left		Right
	State		0		0
Contacts	N/O		open	open	
	N/C		closed	closed	

Position 45°



Push	Position	Top			
		Bottom			
	Location		Left		Right
	State		1		1
Contacts	N/O		closed	closed	
	N/C		open	open	

Technical Illustration

Dimensions

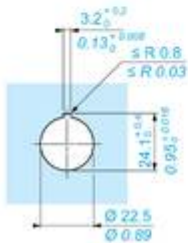
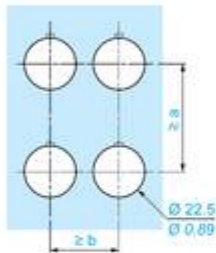
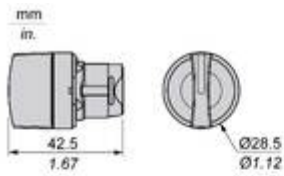

		a (mm)	a (in.)	b (mm)	b (in.)
		40	1.57	30	1.18
ZBE.....	ZBV.....				
		45	1.77	32	1.26
ZBE.....3	ZBV.....3				
		40	1.57	30	1.18
ZBE.....4	ZBV.....4				
		50	1.97	30	1.18
ZBE.....5	ZBV.....5				
		40	1.57	30	1.18
ZBE.....9	ZBV.....9				
		40	1.57	30	1.18
ZBRT..	ZBRV1				

Offer Marketing Illustration

Product benefits / Features

---

### Features Harmony XB5



- 

Quick and easy assembly and disassembly
- 

Excellent mechanical connection with operator head
- 

Various types of connection: screw clamp, connector, Faston connector, spring terminal, or printed circuit board
- 

Robustness to withstand harsh environments
- 

Large set of accessories to customize your panels

Offer Marketing Illustration

Product benefits / Features

---

## Technical Benefits

Harmony XB5

Conformity with IEC, UL, CSA, CCC EAC, and JIS standards, as well as CE marking and marine approvals

Up to IP66, 67, 69, 69K, and type 4X protection ratings

High vibration resistance with shake-proof terminal screws



Operating temperature from -40°C to 70°C

Shock protection level up to IK06

Secure switching of inductive or heavy DC loads directly – 100 000 operations at 10A, 24V dc

Image of product / Alternate images

Alternative

---

