

Produktdatablad

Specifikationer



Harmony potentiometerhoved i metal for montering af løst potentiometer med Ø6 mm aksel

El-nr.:
7517803780

ZB4BD912

EAN-nr: 3389110896879

Egenskaber

Produktserie	Harmony XB4
Produkttype	Hoved + montagesæt til potentiometer
Enhedsforkortelse	ZB4
Materiale og farve på frontring	Forkromet metal
Montagediameter	22 mm
Produktet passer med	Til brug med Ø 6 mm aksel
Mindst mulige salgsantal	1
Hovedtype	Standard

Produktinformationer

Vægt	0,08 kg
Modstandsdygtighed overfor højtryksrensning	7000000 Pa ved 55 °C, distance : 0.1 m
Form på hoved	Rundt
Betjeningsprofil	Rund knop, med (Hvid)
Konstruktion	Som løsedele

Miljø

Beskyttelsesbehandling	TH
Omgivelsestemperatur ved opbevaring	-40...70 °C
Omgivelsestemperatur under drift	-40...70 °C
Beskyttelsesklasse	Klasse I i henhold til IEC 60536
IP kapslingsklasse	IP66 i henhold til IEC 60529
NEMA kapslingsklasse	NEMA 13 NEMA 4X
IP kapslingsklasse	IK03 conforming to IEC 50102
Standarder	UL 508 IEC 60947-1 JIS C8201-5-1 IEC 60947-5-4 IEC 60947-5-1 CSA C22.2 No 14 IEC 60947-5-5 JIS C8201-1

Produktcertificeringer	CSA DNV BV LROS (Lloyds register of shipping) UL listet
Vibrationsmodstand	5 gn (f= 2...500 Hz) conforming to IEC 60068-2-6
Modstandsdygtighed overfor stød	30 gn (varighed = 18 millisekund) til Halv sinusbølge acceleration i henhold til IEC 60068-2-27 50 gn (varighed = 11 millisekund) til Halv sinusbølge acceleration i henhold til IEC 60068-2-27

Forpakkingsinformation

Enhedstype af pakke 1	PCE
Antal enheder i pakke 1	1
Pakke 1 Højde	4,5 cm
Pakke 1 Længde	5,5 cm
Package 1 Length	5,5 cm
Pakke 1 Vægt	80,0 g
Enhedstype af pakke 2	S02
Antal enheder i pakke 2	80
Pakke 2 Højde	15,0 cm
Pakke 2 Bredde	30,0 cm
Pakke 2 Længde	40,0 cm
Pakke 2 Vægt	6,653 kg

Logistik informationer

Oprindelsesland	FR
------------------------	----

Garanti

Garanti	18 months
----------------	-----------

Environmental Data

Schneider Electric's mål er at opnå Net Zero-status i 2050 gennem partnerskaber med forsyningskæden, materialer med lavere påvirkning og cirkularitet via vores igangværende kampagne "Use Better, Use Longer, Use Again" for at forlænge produkternes levetid og genbrugelighed.

[Forklaring af Environmental Data >](#)

[Sådan vurderer vi produktets bæredygtighed >](#)

Miljøfodaftryk

CO2-belastning (kg CO2 eq.) 1

Miljøoplysning [Miljøprofil for produkt](#)

Use Better

Materialer og emballage

Pakke med genbrugspap Yes

Emballage uden plast No

[EU RoHS-direktivet](#) Proaktiv overensstemmelse (produkt ikke omfattet af EU RoHS)

Reach-forordning [REACH-erklæring](#)

Use Again

Ompakning og genfremstilling

Cirkularitetsprofil [Oplysninger om udtjent udstyr](#)

Returnering No

Dimensions Drawings

Dimensions

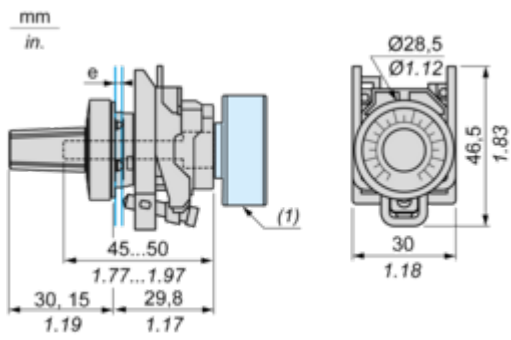

e: panel thickness: 1 to 6 mm / 0.04 to 0.24 in.

(1) Potentiometer not included

Mounting and Clearance

Panel Cut-out for Pushbuttons, Switches and Pilot Lights (Finished Holes, Ready for Installation)

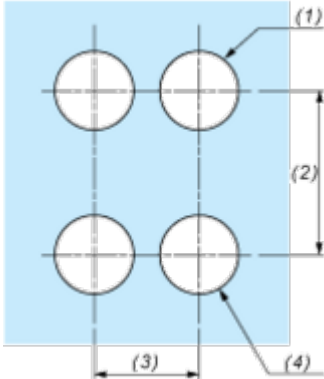
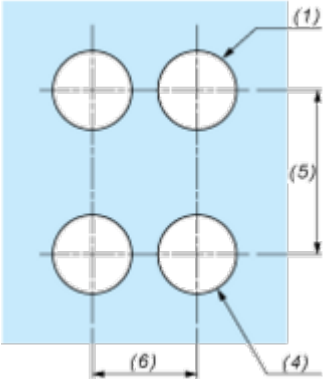
Connection by Screw Clamp Terminals or Plug-in Connectors	Connection by Faston Connectors
	
<p>(1) Diameter on finished panel or support (2) 40 mm min. / 1.57 in. min. (3) 30 mm min. / 1.18 in. min. (4) $\varnothing 22.5 \text{ mm} / 0.89 \text{ in. recommended } (\varnothing 22.3 \text{ mm } ^{+0.4}_0 / 0.88 \text{ in. } ^{+0.016}_0)$ (5) 45 mm min. / 1.78 in. min. (6) 32 mm min. / 1.26 in. min.</p>	

Technical Illustration

Dimensions

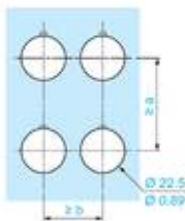
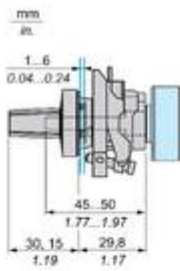

		a (mm)	a (in.)	b (mm)	b (in.)
		40	1.57	30	1.18
ZBE.....	ZBV.....				
		45	1.77	32	1.26
ZBE.....3	ZBV.....3				
		40	1.57	30	1.18
ZBE.....4	ZBV.....4				
		50	1.97	30	1.18
ZBE.....5	ZBV.....5				
		40	1.57	30	1.18
ZBE.....9	ZBV.....9				
ZBRT*	ZBRV1	40	1.57	30	1.18

Offer Marketing Illustration

Product benefits / Features

Technical Benefits

Harmony XB4

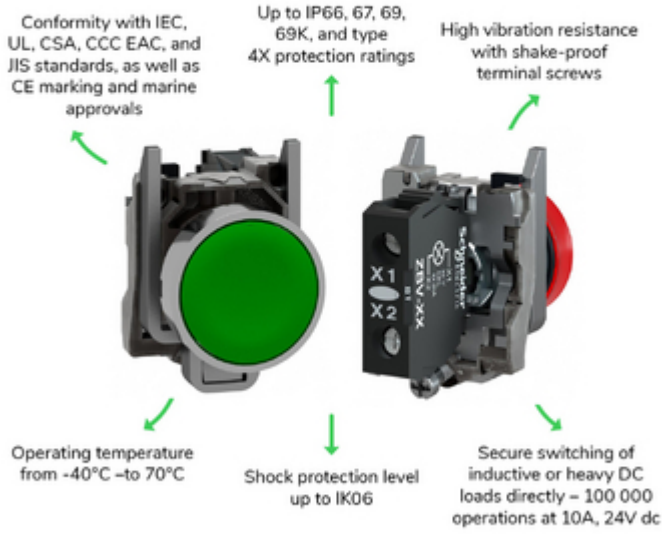

Offer Marketing Illustration

Product benefits / Features

Features
Harmony XB4





-  Quick and easy assembly and disassembly
-  Excellent mechanical connection with operator head
-  Various types of connection: screw clamp, connector, Faston connector, spring terminal, or printed circuit board
-  Large set of accessories to customize your panels
-  Robustness to withstand harsh environments

Image of product / Alternate images

Alternative

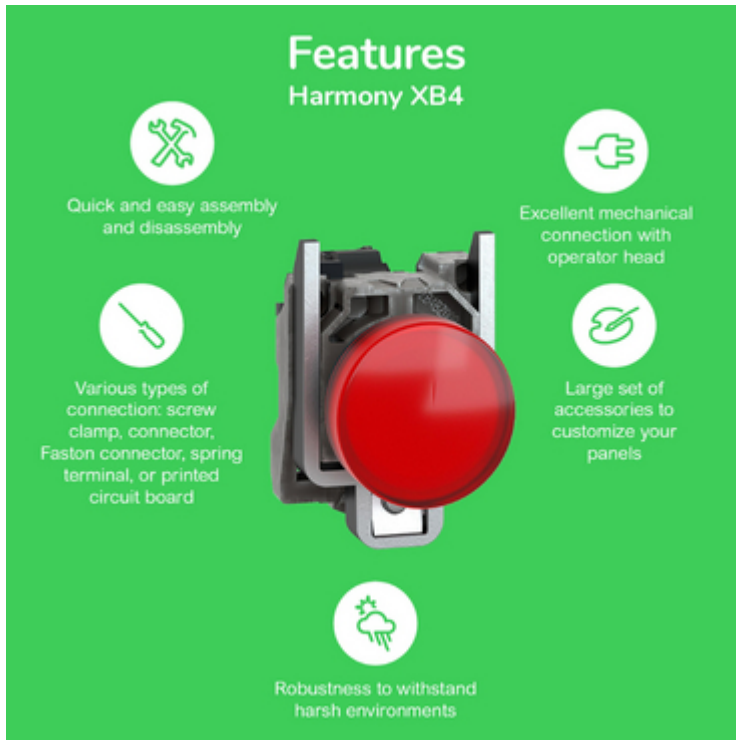