

Produktdatablad

Specifikationer



Frekvensomformer ATV12 0.75kW. 240V

El-nr.:

7565853740

ATV12P075M2

EAN-nr: 3606480071133

Egenskaber

Produktserie	"Altivar 12"
Produkttype	Frekvensomformer
Produktspecifik applikation	Simpel maskine
Montageform	Cabinet mount
Kommunikationsportsprotokol	Modbus
tilslutningsfrekvens	50/60 Hz +/- 5 %
[Us] forsyningspænding	200...240 V - 15...10 %
Nominel udgangsstrøm	4,2 A
motoreffekt i kW	0,75 kW
motoreffekt i hp	1 hp
EMC filter	Indbygget
IP beskyttelsesgrad	IP20
motoreffekt i hp	1 hp

Produktinformationer

digital indgangsnummer	4
antal digitale udgange	2
Analoge Indgange	1
Analoge udgange	1
relæ output antal	1
fysisk interface	2-wire RS 485
Forbindelsestype	"1 RJ45"
vedvarende udgangsstrøm	4,2 A ved 4 kHz
tilgangsmetode	Server modbus serial
hastighed drev output frekvens	0,5...400 Hz
hastighedsområde	1...20
prøvevarighed	20 milisekund, tolerance "+/- 1 ms" til logisk indgang 10 milisekund til analog indgang
linearitetsfejl	+/- 0.3 % af maksimum værdi til analog indgang
frekvensopløsning	Analog indgang: converter A/D, 10 bits Display enhed: 0.1 Hz
tidskonstant	20 milisekund "+/- 1 ms" til reference change

Transmissionshastighed	9.6 kbit/s 19.2 kbit/s 38.4 kbit/s
transmissionsstel	RTU
antal adresser	1...247
dataformat	8 bits, konfigurerbar odd, even eller ingen paritet
kommunikationsfunktioner	Læse holding registers (03) 29 ord Skriv enkelt register (06) 29 ord Skriv multiple registers (16) 27 ord Læs/skriv flere registre (23) 4/4 ord Læse device identifikation (43)
polaritetstype	Ingen impedance
4 quadrant operation possible	Falsk
asynkron motorkontrol	Sensorless flux vector kontrol Voltage/frekvens ratio (V/f) Quadratic spænding/frekvens ratio
Maximum output frequency	4 kHz
transient overmoment	150...170 % of nominal motor torque afhængig på drev rating og type af motor
accelerations- og nedreguleringsrampe	S U Linear fra 0 til 999.9 s
motor kompensation	Fabriksindstillinger Justerbar
frekvens	"2...16 kHz" Justerbar "4...16 kHz" med reducereing
nominel switching frekvens	4 kHz
bremssning ved stilstand	Med DC indsprøjtning
Brake chopper integrated	Falsk
optagen strøm	10,2 A ved "100 V" (heavy duty) 8,5 A ved 120 V (heavy duty)
Maximum input current	8,5 A
Maximum output voltage	240 V
tilsyneladende effekt	2,0 kVA ved 240 V (heavy duty)
maks. transient strøm	6,3 A gennem 60 s (heavy duty) 6,9 A gennem 2 s (heavy duty)
Netværksfrekvens	50...60 Hz
Relative symmetric network frequency tolerance	5 %
prospektiv kortslutningsstrøm I_{sc}	1 kA
Base load current at high overload	4,2 A
effekttab i W	Natural: 44,0 W
With safety function Safely Limited Speed (SLS)	Falsk
With safety function Safe brake management (SBC/SBT)	Falsk
With safety function Safe Operating Stop (SOS)	Falsk
With safety function Safe Position (SP)	Falsk
With safety function Safe programmable logic	Falsk
With safety function Safe Speed Monitor (SSM)	Falsk

With safety function Safe Stop 1 (SS1)	Falsk
With sft fct Safe Stop 2 (SS2)	Falsk
With safety function Safe torque off (STO)	Falsk
With safety function Safely Limited Position (SLP)	Falsk
With safety function Safe Direction (SDI)	Falsk
beskyttelsestype	Forsyning overspænding Forsyning underspænding Overspænding mellem output phases og earth Over varme beskyttelse Kortslutning mellem motor faser Against input fase loss i tre-fase Termisk motor beskyttelse via drev ved continuous calculatipå af I ² t
Tilspændingsmoment	0,8 N.m
isolation	Elektrisk mellem strøm og kontrol
Antal pr. Sæt	Sæt med 1
bredde	72 mm
Højde	143 mm
Dybde	102,2 mm
Vægt	0,7 kg

Miljø

driftshøjde	> 1000...2000 m med strømtab 1 % pr. 100 m <= 1000 m uden tab
Driftsstilling	Vertikal +/- 10 grad
Produktcertificeringer	NOM CSA C-Tick UL GOST RCM KC
Mærkning	CE
Standarder	UL 508C "UL 61800-5-1" IEC 61800-5-1 IEC 61800-3
Montagetype	På base plade
elektromagnetisk kompatibilitet	Immunitetstest overfor hurtige elektriske transienter level 4 conforming to IEC 61000-4-4 Immunitetstest overfor elektrostatisk afladning Level 3 conforming to IEC 61000-4-2 Immunity til conducted disturbances Level 3 conforming to IEC 61000-4-6 Radiated radio-frekvens electromagnetic field immunity test Level 3 conforming to IEC 61000-4-3 Surge immunity test Level 3 conforming to IEC 61000-4-5 Voltage dips and interruptions immunity test conforming to IEC 61000-4-11
Environmental class (during operation)	Class 3C3 according to IEC 60721-3-3 Class 3S2 according to IEC 60721-3-3
Maximum acceleration under shock impact (during operation)	150 m/s ² at 11 ms
Maximum acceleration under vibrational stress (during operation)	10 m/s ² at 13...200 Hz
Maximum deflection under vibratory load (during operation)	1.5 mm at 2...13 Hz
Overspændingskategori	"class III"

Reguleringsstøffe	Justerbar PID regulator
elektromagnetisk stråling	Radiated emissions miljø 1 kategori C2 i henhold til IEC 61800-3 2...16 kHz skærmet motorkabel Conducted emissions med integreret EMC filter miljø 1 kategori C1 i henhold til IEC 61800-3 2, 4, 8, 12 og 16 kHz skærmet motorkabel <5 m Conducted emissions med integreret EMC filter miljø 1 kategori C2 i henhold til IEC 61800-3 2...12 kHz skærmet motorkabel <5 m Conducted emissions med integreret EMC filter miljø 1 kategori C2 i henhold til IEC 61800-3 2, 4 og 16 kHz skærmet motorkabel <10 m Conducted emissions med yderligere EMC filter miljø 1 kategori C1 i henhold til IEC 61800-3 4...12 kHz skærmet motorkabel <20 m Conducted emissions med yderligere EMC filter miljø 1 kategori C2 i henhold til IEC 61800-3 4...12 kHz skærmet motorkabel <50 m Conducted emissions med yderligere EMC filter miljø 2 kategori C3 i henhold til IEC 61800-3 4...12 kHz skærmet motorkabel <50 m
vibrationsmodstand	1 gn (f = 13...200 Hz) i henhold til IEC 60068-2-6 1.5 mm peak til peak (f = 3...13 Hz) - drev unmonteret på symmetrisk DIN skinne - i henhold til IEC 60068-2-6
chokmodstand	15 gn til 11 milisekund i henhold til IEC 60068-2-27
relativ fugtighed	5...95 % Uden kondensering i henhold til "IEC 60068-2-3" 5...95 % uden dryppende vand i henhold til "IEC 60068-2-3"
støjgrænse	0 dB
Forureningsgrad	2
Ambient air transport temperature	-25...70 °C
Temperatur ved drift	-10...40 °C uden tab 40...60 °C med strøm derating 2.2 % pr. °C
Omgivelsestemperatur ved opbevaring	-25...70 °C

Forpakkingsinformation

Enhedstype af pakke 1	PCE
Antal enheder i pakke 1	1
Pakke 1 Højde	11,500 cm
Pakke 1 Længde	18,500 cm
Package 1 Length	19,500 cm
Pakke 1 Vægt	954,000 g
Enhedstype af pakke 2	S06
Antal enheder i pakke 2	45
Pakke 2 Højde	75,000 cm
Pakke 2 Bredde	60,000 cm
Pakke 2 Længde	80,000 cm
Pakke 2 Vægt	56,155 kg

Logistik informationer

Oprindelsesland	ID
------------------------	----

Garanti

Garanti	18 months
----------------	-----------



Environmental Data

Schneider Electric's mål er at opnå Net Zero-status i 2050 gennem partnerskaber med forsyningskæden, materialer med lavere påvirkning og cirkularitet via vores igangværende kampagne "Use Better, Use Longer, Use Again" for at forlænge produkternes levetid og genbrugelighed.



[Forklaring af Environmental Data](#) >

[Sådan vurderer vi produktets bæredygtighed](#) >

Use Better

 Materialer og emballage	
Pakke med genbrugspap	Yes
Emballage uden plast	Yes
EU RoHS-direktivet	Proaktiv overensstemmelse (produkt ikke omfattet af EU RoHS)
SCIP-nummer	E831a08f-030e-4f51-9ca5-d70da243cc08
Reach-forordning	REACH-erklæring
 Energieffektivitet	
ProduktBidragUndgået	Yes

Use Again

 Ompakning og genfremstilling	
Returnering	No
WEEE	 Produktet skal bortskaffes på EU's markeder efter en specifik affaldsindsamling og må aldrig ende i skraldespande

Dimensions Drawings

Dimensions

Drive without EMC Conformity Kit

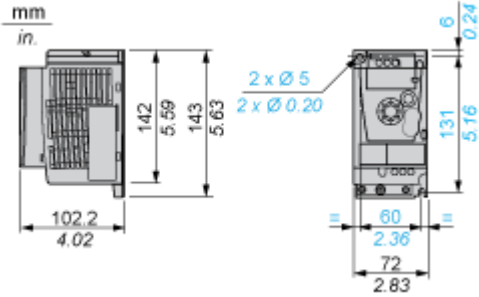

Drive with EMC Conformity Kit

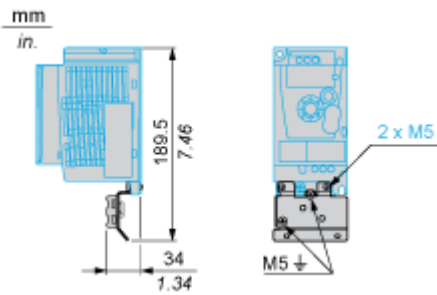

Mounting and Clearance

Mounting Recommendations

Clearance for Vertical Mounting



Mounting Type A



Mounting Type B

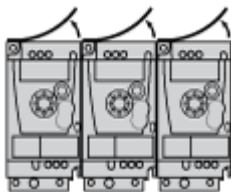

Remove the protective cover from the top of the drive.

Mounting Type C



Remove the protective cover from the top of the drive.

Connections and Schema

Single-Phase Power Supply Wiring Diagram

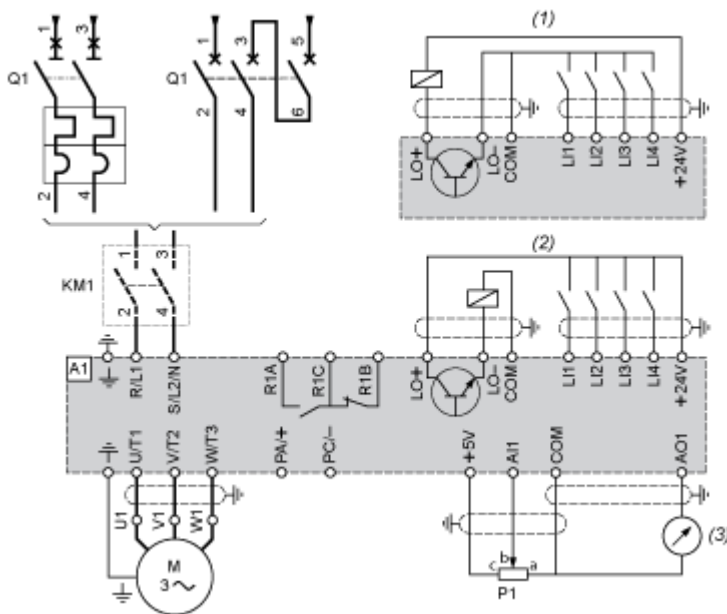

A1 Drive

KM1 Contactor (only if a control circuit is needed)

P1 2.2 kΩ reference potentiometer. This can be replaced by a 10 kΩ potentiometer (maximum).

Q1 Circuit breaker

(1) Negative logic (Sink)

(2) Positive logic (Source) (factory set configuration)

(3) 0...10 V or 0...20 mA

Recommended Schemes

2-Wire Control for Logic I/O with Internal Power Supply



- LI1 : Forward
- LI• : Reverse
- A1 : Drive

3-Wire Control for Logic I/O with Internal Power Supply



- LI1 : Stop
- LI2 : Forward
- LI• : Reverse
- A1 : Drive

Analog Input Configured for Voltage with Internal Power Supply



- (1) 2.2 kΩ...10 kΩ reference potentiometer
- A1 : Drive

Analog Input Configured for Current with Internal Power Supply



- (2) 0-20 mA 4-20 mA supply
- A1 : Drive

Connected as Positive Logic (Source) with External 24 vdc Supply

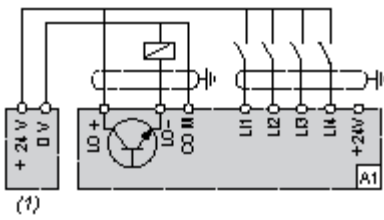

(1) 24 vdc supply

A1 : Drive

Connected as Negative Logic (Sink) with External 24 vdc supply

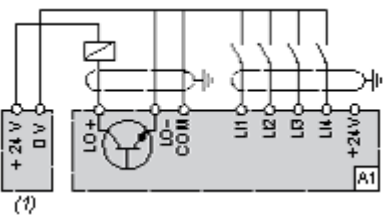

(1) 24 vdc supply

A1 : Drive

Performance Curves

Torque Curves



- 1 : Self-cooled motor: continuous useful torque (1)
- 2 : Force-cooled motor: continuous useful torque
- 3 : Transient overtorque for 60 s
- 4 : Transient overtorque for 2 s
- 5 : Torque in overspeed at constant power (2)

(1) For power ratings ≤ 250 W, derating is 20% instead of 50% at very low frequencies.

(2) The nominal motor frequency and the maximum output frequency can be adjusted from 0.5 to 400 Hz. The mechanical overspeed capability of the selected motor must be checked with the manufacturer.

Image of product / Alternate images

Alternative





