

545D6306

545D0306



WiFer™

Schneider Electric



LED 200 W

2000 W

1050 VA

500 VA

2200 W

200 W

C 10 A, 140 µF

M 1000 VA

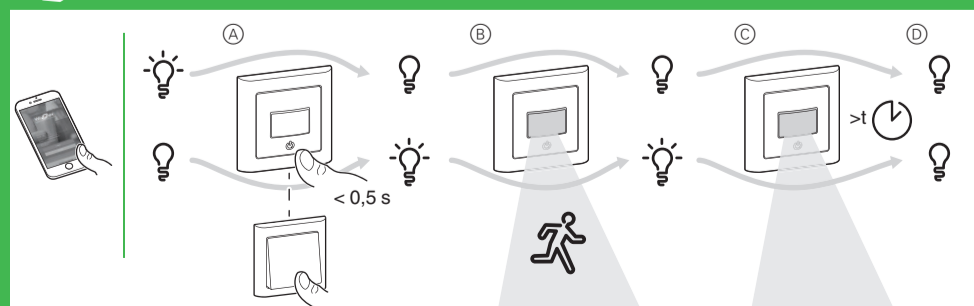
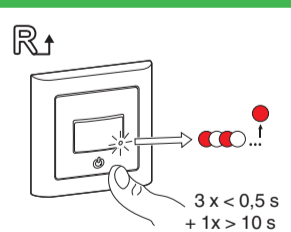
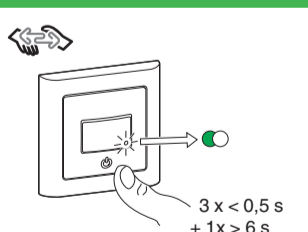
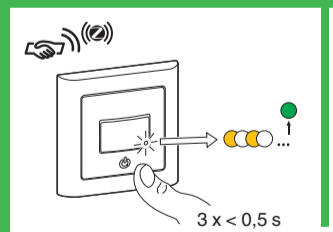
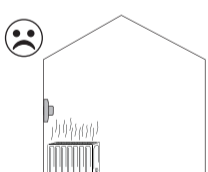
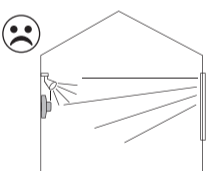
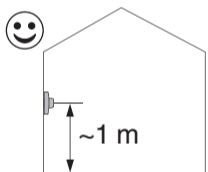
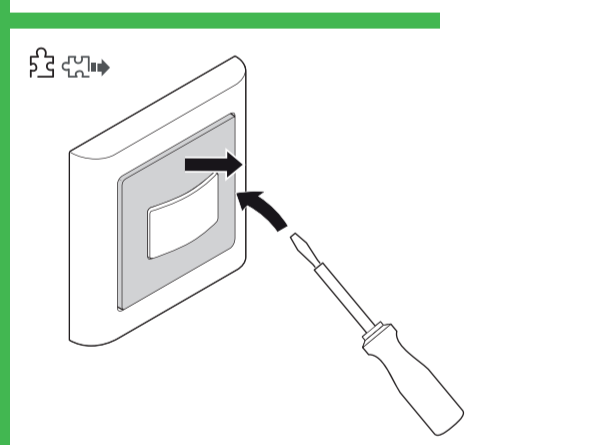
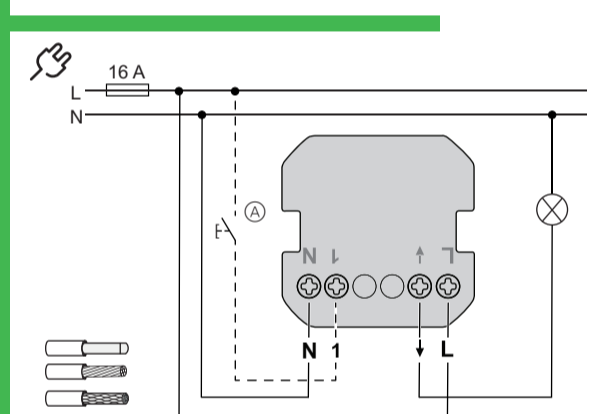
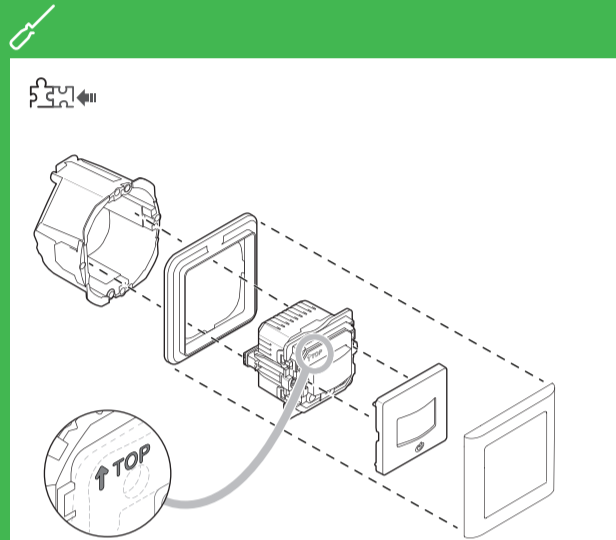
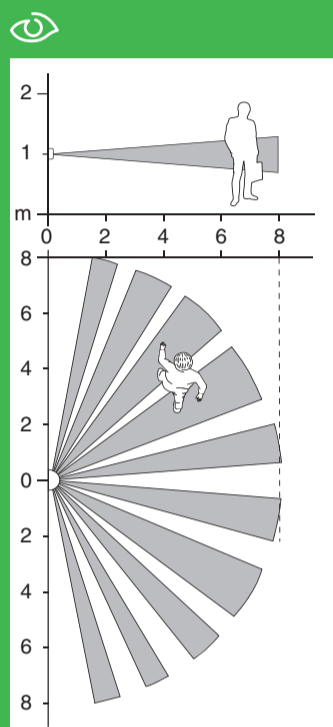

da LK FUGA® Wiser trådløs PIR med relæ

Nødvendigt tilbehør

Installeres med:

- Ramme i tilsvarende design

Forudsætninger

Download **Wiser app'en** til din smartphone / tablet, og installer **Wiser Gateway** for at konfigurere og styre dine Wiser enheder.

Produktinformation er tilgængelig

Detaljeret produktinformation er tilgængelig online i **systemvejledningen**: Scan QR-koden eller følg linket:



<https://www1.lk.dk/wiser>

Af hensyn til din sikkerhed

▲ ▲ FARE

FARE FOR ELEKTRISK STØD, EKSPLOSION ELLER LYSBUE

En sikker elektrisk installation kræver viden på følgende områder:

- Tilslutning til el-installation
- Tilslutning af elektriske apparater
- Udlægning af elektriske kabler
- Sikkerhedsstandarder, lokale installationsregler og forskrifter

Manglende overholdelse af disse instruktioner vil resultere i død eller alvorlig personskade.

Lær produktet at kende

LK FUGA® Wiser trådløs PIR med relæ (i det følgende benævnt **PIR**) registrerer bevægelige varmekilder (f.eks. personer) og kan tænde for ohmsk, induktiv eller kapacitiv belastning i en indstillelig efterløbstid.

Styringsmuligheder

Wiser app: For at styre PIR'en gennem **Wiser-app'en** skal du bruge **Wiser Gateway**.

Rumstyring: For at styre PIR'en med andre Wiser enheder kan den parres med andre Wiser enheder inden for det samme Zigbee-netværk.

Direkte betjening: PIR'en kan altid betjenes direkte på stedet. Du kan også tilslutte et vilkårligt antal mekaniske trykknapper

Funktioner

- Detektionsområde
- Automatisk tilstand, manuel betjening

Valg af installationssted

Undgå uønsket skift af lys og varmekilder i PIR'ens detektionsområde.

Installation



- Ⓐ Mekanisk trykknop ved tilslutning af ekstern betjening (valgfri).

Fjern dækslet



Fjern tangent.



Opretter forbindelse til Wiser Gateway



Yderligere oplysninger findes i systemets brugervejledning.

Parring med andre Wiser enheder

For at styre produktet i en rumstyring kan det parres med andre Wiser-enheder inden for det samme Zigbee-netværk.

Yderligere oplysninger findes i systemets brugervejledning.

Nulstilling af Wiser forbindelser



Alle styringer mellem enheden og andre Wiser enheder slettes.

Nulstilling til fabriksindstillinger



Alle konfigurationsdata, brugerdata og netværksdata slettes.

Alle indstillinger indstilles derefter til fabriksindstillinger.

Betjening

- Ⓐ Tænd / sluk for belastningen på trykknappen eller med forlængelsesenheden.
 - Ⓑ Belastningen forbliver tændt / slukket under bevægelsesdetekteringen.
 - Ⓒ Belastningen forbliver tændt / slukket i den indstillede tid.
 - Ⓓ PIR'en skifter til automatisk tilstand. Hvis belastningen var tændt, bliver den slukket.
- Du kan fjernstyre PIR'en via Wiser-app'en.

Betydning af status lysdiode

Yderligere oplysninger findes i systemets brugervejledning.

Fejlfinding

Yderligere oplysninger findes i systemets brugervejledning.

Tekniske data

Mærkespænding: 230 V ac., 50 Hz

Mærkeeffekt: W

Standby: maks. 0,4 W

Tilslutningsklemmer: Skrueskruer til maks. 2 x 2,5 mm², 0,5 Nm

Tilspændingsmoment for fastgørelse af klo: maks. 0,5 Nm

Ekstern betjening: Fjederbelastet tryk, ubegrænset antal, maks. 50 m

Forsikring: 16 A

Mærkestrøm: 10 A, cosφ = 0,6

Driftsfrekvens: 2405-2480 MHz

Maks. transmitteret radioeffekt: <math>< 10\text{ mW}</math>

Kommunikationsprotokol: Zigbee 3.0 certificeret

Bortskaf enheden separat fra husholdningsaffaldet på et officielt deponeringssted. Professionelt genbrug beskytter personer og miljøet mod potentielle negative effekter.

Varemærker

- Wiser™ tilhører Schneider Electric SE, dets datterselskaber og tilknyttede virksomheder.
- Zigbee® er et registreret varemærke tilhørende Zigbee Alliance.
- Apple® og App Store® er mærkenavne eller registrerede varemærker tilhørende Apple Inc.
- Google Play™ Store og Android™ er mærkenavne eller registrerede varemærker tilhørende Google Inc.

EU-overensstemmelseserklæring

Schneider Electric Danmark A/S erklærer hermed, at dette produkt er i overensstemmelse med de væsentlige krav og andre relevante bestemmelser i DIREKTIV 2014/53/EU OM RADIOUDSTYR. Overensstemmelseserklæringen kan downloades på: schneider-electric.com/docs.

Lauritz Knudsen

Schneider Electric Danmark A/S, Lautrupvang 1, 2750 Ballerup, Telefon: +45 88 30 20 00, www.lk.dk

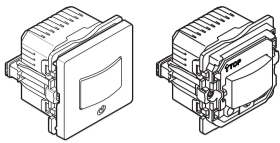

545D6306

545D0306

Download on the App Store

GET IT ON Google Play

WiFer™

Schneider Electric



LED 200 W

2000 W

1050 VA

500 VA

2200 W

200 W

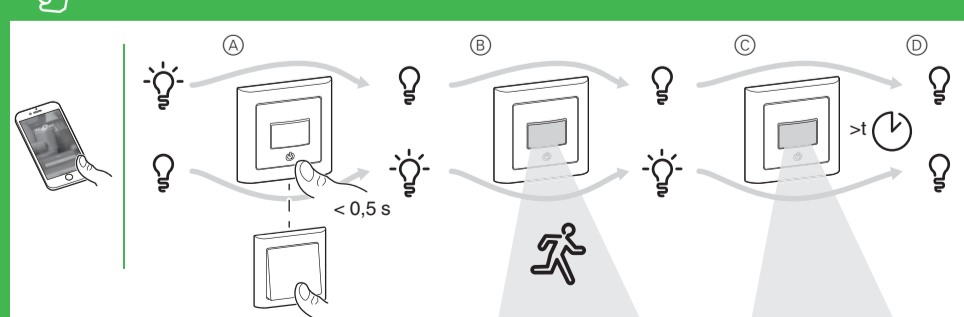
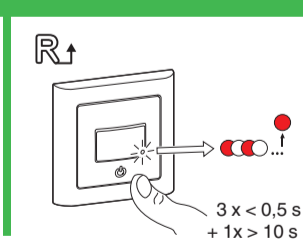
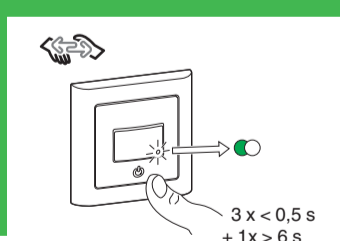
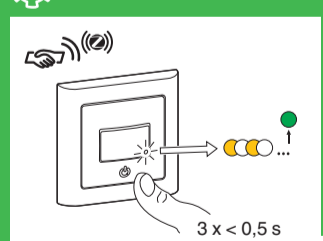
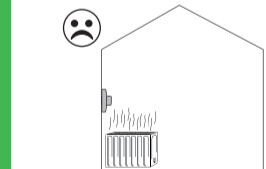
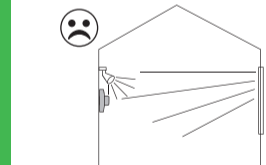
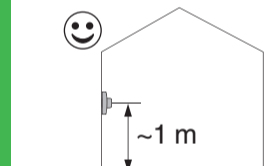
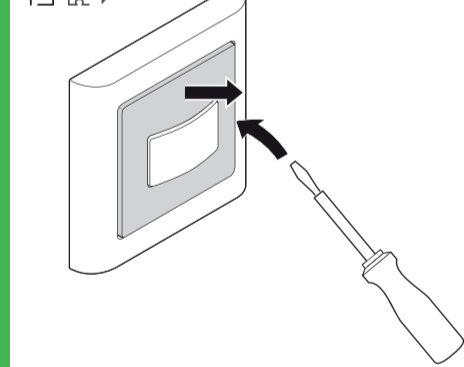
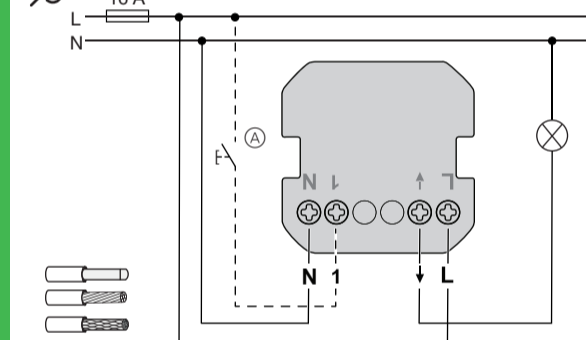
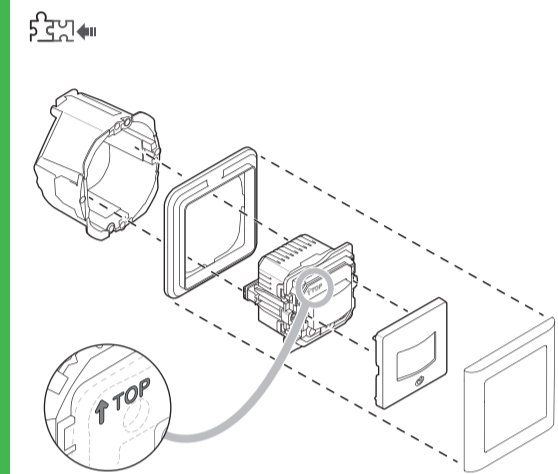
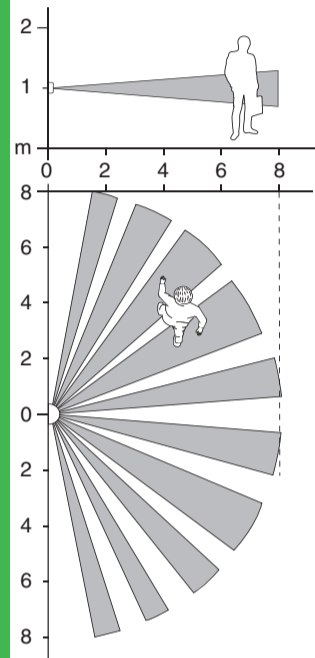
C 10 A, 140 µF**(M)** 1000 VA**Necessary accessories**

To be completed with:

- Frame in corresponding design

Prerequisites

Download the **Wiser app** to your smartphone / tablet, and install the **Wiser Gateway** to configure and control Wiser devices.

Product information is available

Detailed product information is available online in the **system user guide**. Scan the QR code or follow the link:

<https://www1.lk.dk/wiser>**For your safety****⚠️ DANGER****HAZARD OF ELECTRIC SHOCK, EXPLOSION, OR ARC FLASH**

Safe electrical installation must be carried out only by skilled professionals. Skilled professionals must prove profound knowledge in the following areas:

- Connecting to installation networks
- Connecting several electrical devices
- Laying electric cables
- Safety standards, local wiring rules and regulations

Failure to follow these instructions will result in death or serious injury.

Getting to know the product

The LK FUGA® Wiser wireless PIR with relay (hereinafter referred to as **motion sensor**) detects moving heat sources (e.g. persons) and can switch on ohmic, inductive or capacitive loads for a settable overtravel time.

Control options

Home control: To control the motion sensor through the **Wiser app** you will need the **Wiser Gateway**.

Room control: To control the motion sensor with other Wiser devices, it can be paired with other Wiser devices within the same Zigbee network.

Direct operation: The motion sensor can always be controlled directly on-site. You can also connect any number of mechanical push-buttons.

Functions

- Detection range
- Automatic mode, manual operation

Selecting the installation site

Avoid undesired switching by light and heat sources in the detection range of the motion sensor.

Installing

- Ⓐ Mechanical push-button at extension unit connection (optional).

Removing the cover

Remove the rocker switch.

Setting up**Connecting to the Wiser Gateway**

For more details, refer to the system user guide.

Pairing to other Wiser devices

To control the product in a room control mode, it can be paired with other Wiser devices within the same Zigbee network.

For more details, refer to the system user guide.

Resetting Wiser connectivity

All control links between the device and other Wiser devices are deleted.

Resetting to default settings

All configuration data, user data and network data are deleted.

All settings are then set to default settings.

Operating

- Ⓐ Switch the load on/off with the push-button or extension unit.
 - Ⓑ The load remains switched on/off during the motion detection.
 - Ⓒ The load remains switched on/off for the duration of the set time.
 - Ⓓ The motion sensor switches to automatic mode. If the load was switched on, it is now switched off.
- You can remotely control the motion sensor via the Wiser app.

Behaviour of the status LED

For more details, refer to the system user guide.

Troubleshooting

For more details, refer to the system user guide.

Technical data

Nominal voltage: AC 230 V ~, 50 Hz

Nominal power:

Standby: max. 0.4 W

Connecting terminals: Screw terminals for max. 2 x 2.5 mm², 0.5 Nm

Claw fixation torque: max. 0.5 Nm

Extension unit: Single push-button, unlimited number, max. 50 m

Fuse protection: 16 A circuit breaker

Nominal current: 10 A, cosφ = 0.6

Operating frequency: 2405-2480 MHz

Max. radio-frequency power transmitted: < 10 mW

Communication protocol: Zigbee 3.0 certified



Dispose of the device separately from household waste at an official collection point. Professional recycling protects people and the environment against potential negative effects.

Trademarks

- Wiser™ is a trademark and the property of Schneider Electric SE, its subsidiaries and affiliated companies.
- Zigbee® is a registered trademark of the Zigbee Alliance.
- Apple® and App Store® are brand names or registered trademarks of Apple Inc.
- Google Play™ Store and Android™ are brand names or registered trademarks of Google Inc.

EU Declaration of conformity

Hereby, Schneider Electric Danmark A/S, declares that this product is in compliance with the essential requirements and other relevant provisions of RADIO EQUIPMENT DIRECTIVE 2014/53/EU. Declaration of conformity can be downloaded on: schneider-electric.com/docs.

Lauritz Knudsen

Schneider Electric Danmark A/S, Lautrupvang 1, 2750 Ballerup, Phone: +45 88 30 20 00, www.lk.dk