

# Wiser Multiwire Micro Module LED Dimmer

## Device user guide

Information about features and functionality of the devices.

01/2024

Lauritz Knudsen 



# Legal Information

The information provided in this document contains general descriptions, technical characteristics and/or recommendations related to products/solutions.

This document is not intended as a substitute for a detailed study or operational and site-specific development or schematic plan. It is not to be used for determining suitability or reliability of the products/solutions for specific user applications. It is the duty of any such user to perform or have any professional expert of its choice (integrator, specifier or the like) perform the appropriate and comprehensive risk analysis, evaluation and testing of the products/solutions with respect to the relevant specific application or use thereof.

The Schneider Electric brand and any trademarks of Schneider Electric SE and its subsidiaries referred to in this document are the property of Schneider Electric SE or its subsidiaries. All other brands may be trademarks of their respective owner.

This document and its content are protected under applicable copyright laws and provided for informative use only. No part of this document may be reproduced or transmitted in any form or by any means (electronic, mechanical, photocopying, recording, or otherwise), for any purpose, without the prior written permission of Schneider Electric.

Schneider Electric does not grant any right or license for commercial use of the document or its content, except for a non-exclusive and personal license to consult it on an "as is" basis.

Schneider Electric reserves the right to make changes or updates with respect to or in the content of this document or the format thereof, at any time without notice.

**To the extent permitted by applicable law, no responsibility or liability is assumed by Schneider Electric and its subsidiaries for any errors or omissions in the informational content of this document, as well as any non-intended use or misuse of the content thereof.**

---

# Table of Contents

Safety Information.....	4
Wiser Multiwire Micro Module LED Dimmer .....	5
For your safety .....	5
About the device.....	7
Installing the device .....	7
Testing the device.....	7
Quick Home Connect.....	8
About Quick Home Connect.....	8
Installing dimmer for Quick Home Connect .....	8
Pairing Wireless switch with Dimmer .....	9
Pairing two dimmers.....	11
Adjusting the brightness .....	12
Operating a dimmer in Quick Home Connect.....	14
Resetting the device in Quick Home Connect.....	14
LED indications in Quick Home Connect.....	15
Troubleshooting in Quick Home Connect .....	15
Pairing the device with Wiser Gateway.....	16
Pairing device manually.....	16
Pairing device with auto scan.....	19
Checking the type of wiring mode .....	20
Configuring the device .....	21
Changing the device icon .....	21
Renaming the device .....	22
Changing the device location .....	22
Dimmer settings.....	23
Using the device.....	25
Manual operation .....	26
Adjusting the brightness level using app .....	26
Setting up a schedule.....	28
Push button control .....	29
Creating a moment .....	38
Creating an automation .....	41
Removing the device .....	46
Resetting the device .....	47
LED indication.....	48
Troubleshooting .....	48
Technical data .....	49
Compliance.....	50
Compliance information for Green Premium products.....	50
EU Declaration of Conformity .....	51
Trademarks.....	51

# Safety Information

## Important Information

Read these instructions carefully and look at the equipment to become familiar with the device before trying to install, operate, service, or maintain it. The following special messages may appear throughout this manual or on the equipment to warn of potential hazards or to call attention to information that clarifies or simplifies a procedure.



The addition of either symbol to a “Danger” or “Warning” safety label indicates that an electrical hazard exists which will result in personal injury if the instructions are not followed.



This is the safety alert symbol. It is used to alert you to potential personal injury hazards. Obey all safety messages that accompany this symbol to avoid possible injury or death.

### **DANGER**

**DANGER** indicates a hazardous situation which, if not avoided, **will result in** death or serious injury.

**Failure to follow these instructions will result in death or serious injury.**

### **WARNING**

**WARNING** indicates a hazardous situation which, if not avoided, **could result in** death or serious injury.

### **CAUTION**

**CAUTION** indicates a hazardous situation which, if not avoided, **could result in** minor or moderate injury.

### **NOTICE**

NOTICE is used to address practices not related to physical injury.

# Wiser Multiwire Micro Module LED Dimmer



CCT5010-0003

## For your safety

### **⚠️⚠️ DANGER**

#### **HAZARD OF ELECTRIC SHOCK, EXPLOSION, OR ARC FLASH**

Safe electrical installation must be carried out only by skilled professionals. Skilled professionals must prove profound knowledge in the following areas:

- Connecting to installation networks.
- Connecting several electrical devices.
- Laying electric cables.
- Safety standards, local wiring rules and regulations.

**Failure to follow these instructions will result in death or serious injury.**

### **⚠️ DANGER**

#### **HAZARD OF ELECTRIC SHOCK**

- Make sure that the terminal connection area does not come in contact with the metallic parts of any device installed in the same location.
- Do not short the outputs to neutral.

**Failure to follow these instructions will result in death or serious injury.**

### **⚠️ CAUTION**

#### **EQUIPMENT DAMAGE**

- Always operate the product in compliance with the specified technical data.
- Never connect any mixed inductive/capacitive loads.
- Connect only dimmable loads.
- Do not connect the dimmer output to the socket outlet.
- Ensure that the device is disconnected from its circuit during the insulation resistance test.

**Failure to follow these instructions can result in injury or equipment damage.**



## About the device

The Wiser Multiwire Micro Module LED Dimmer (hereinafter referred to as Dimmer / Dimmer Micromodule) combines the advantages of smart dimmer functionality with ordinary mechanical push-button switches. It transforms a conventional switch into a connected device which can be controlled from the switch or through the Wiser app. It can switch and dim the ohmic or capacitive loads and it is also compatible with dimmable LEDs.

**NOTE:** Do not control any devices that depend on a permanent power supply.

Additional features:

- Remote control with maximum of 10 single mechanical push-buttons.
- Setting the LED operating mode manually (RL LED mode).
- Electronic overload protection, overheating protection, and short-circuit protection.
- Setting the dimming range: minimum and maximum brightness.
- Setting a time schedule.

## Installing the device

Refer to the installation instruction supplied with this product.

See Wiser Multiwire Micro Module LED Dimmer.

## Testing the device

Before using the dimmer, manually test it and make sure that it works when connected to the lighting devices.

### ⚠ WARNING

#### HAZARD OF ELECTRIC SHOCK

- Observe the regulations for working on live parts.
- Only actuate the device buttons using insulated auxiliary equipment that meets the requirements of EN 60900.

**Failure to follow these instructions can result in death, serious injury, or equipment damage.**

- Short press the Set (Setup/Reset) button once, the connected lighting device turns on/off.
- Press and hold the Set (Setup/Reset) button to adjust the dimming level of the connected lighting device.

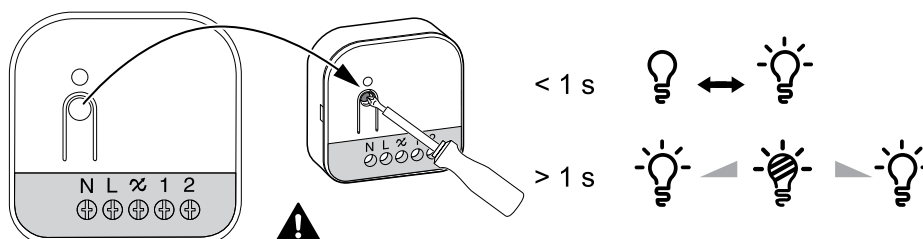

## Quick Home Connect

### About Quick Home Connect

Quick Home Connect is a wireless connectivity solution for Zigbee devices without the need for a Gateway or smartphone application. Quick Home Connect is your starting point for wireless home automation. It performs functions like switching and dimming using the LK FUGA® Wiser wireless battery 4 button switch (hereinafter referred to as Wireless switch) via a Zigbee.

The **Wireless switch** is a battery-powered wireless push-button switch that is used to control Zigbee devices (such as dimmer) within the same Zigbee network.

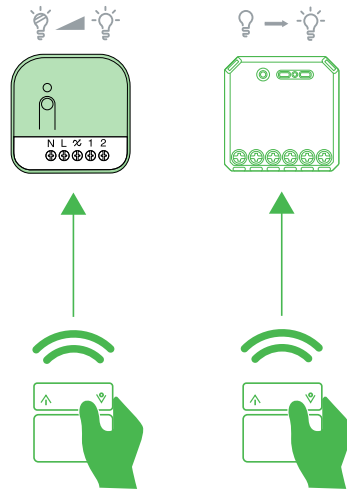

### Installing dimmer for Quick Home Connect

**IMPORTANT:** The electrical connection to terminal 2 is mandatory for Quick Home Connect to function.

Refer below wiring diagram.

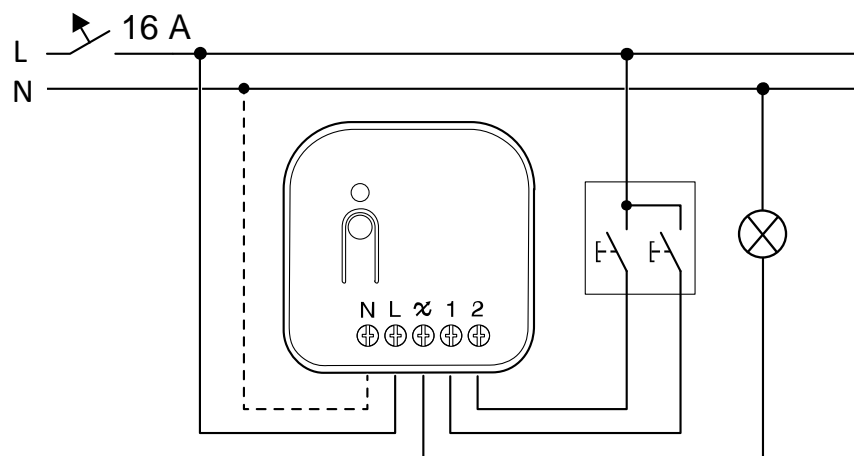

## Pairing Wireless switch with Dimmer

To pair the Wireless switch to the Dimmer, both devices must be in pairing mode at the same time.

**IMPORTANT:** The electrical connection to terminal 2 is mandatory for quick home connect to function.

Refer Installing dimmer, page 8 for wiring diagram.

**NOTE:** The pairing mode will be active for about a minute.

1. Replace the lower rocker of the Wireless switch and cover with the blind plate.

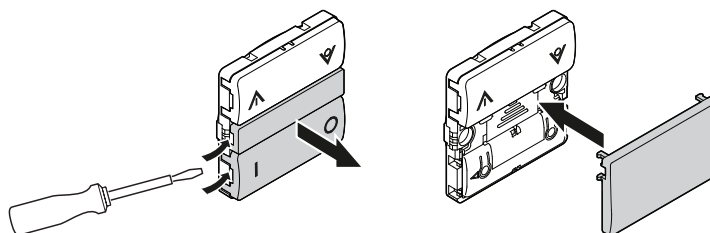

2. Short press the left side of the rocker 5 times in quick succession on the Wireless switch.

The status LED blinks green.

**NOTE:** The status LED is not directly visible.

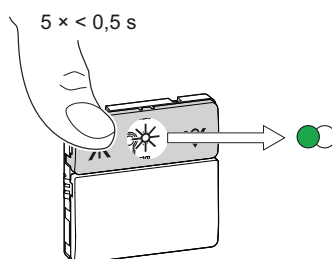

### ⚠ WARNING

#### HAZARD OF ELECTRIC SHOCK

- Observe the regulations for working on live parts.
- Only actuate the device buttons using insulated auxiliary equipment that meets the requirements of EN 60900.

**Failure to follow these instructions can result in death, serious injury, or equipment damage.**

## 3. Follow any one of the options to pair the Dimmer:

- Short press the (setup/reset) button 5 times in quick succession on the Dimmer with a screwdriver (A).
- Short press the mechanical push-button 5 times in quick succession (B).

The status LED blinks green on the Dimmer LED.

**NOTE:** If the Dimmer is located behind the mechanical push-button, the status LED is not visible.

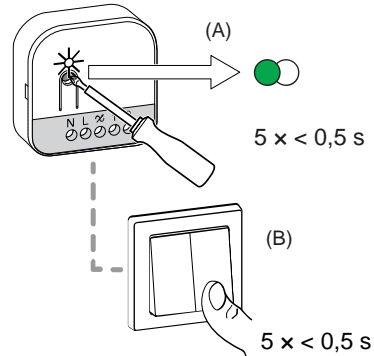

The light connected to the Dimmer blinks for a few times. The status LED stops blinking green on the Wireless switch and the Dimmer. The Dimmer can now be controlled by the Wireless switch.

## Pairing two dimmers

You can pair 2 dimmer modules as a part of Quick Home Connect for wireless home automation.

**NOTE:**

- One or more dimmer modules should be connected with a 2 gang push-button.
- You must put the both the dimmer modules in a pairing mode at the same time. The pairing mode will be active for about a minute.

Below are 2 scenarios where you can pair the dimmer modules with each other.

**Scenario 1:** Dimmer 1 is wired to mechanical push buttons and dimmer 2 is not connected.

Upon pairing, you can control the dimmer 2 light from dimmer 1.

1. On dimmer 1, short press the mechanical push button-2 for 5 times in quick succession (A).
2. On dimmer 2, short press the Set (setup/reset) button 5 times in quick succession on the dimmer with a screwdriver (B).

The status LED blinks green on the dimmer LED.

**NOTE:** If the dimmer is located behind the mechanical push-button, the status LED is not visible.

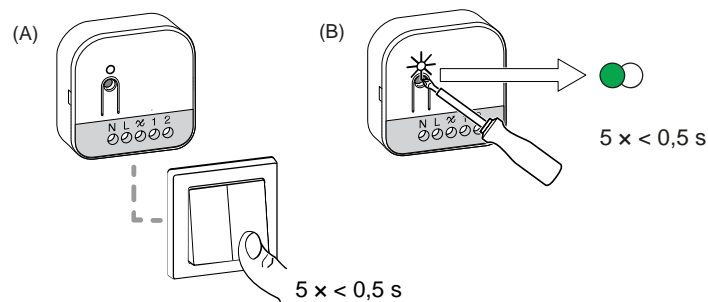

The light connected to the dimmer blinks for a few times. The dimmer can now be controlled by the push-button.

**Scenario 2:** Both dimmer are wired to their respective push-buttons.

Upon pairing, both the dimmer can be controlled vice versa. That means dimmer 1 can control dimmer 2 and dimmer 2 can control dimmer 1.

1. On dimmer 2, short press the mechanical push button-2 for 5 times in quick succession (A).
2. On dimmer 1, short press the Set (setup/reset) button 5 times in quick succession on the dimmer with a screwdriver (B).

**NOTE:** Dimmer is located behind the mechanical push-button, the status LED is not visible.

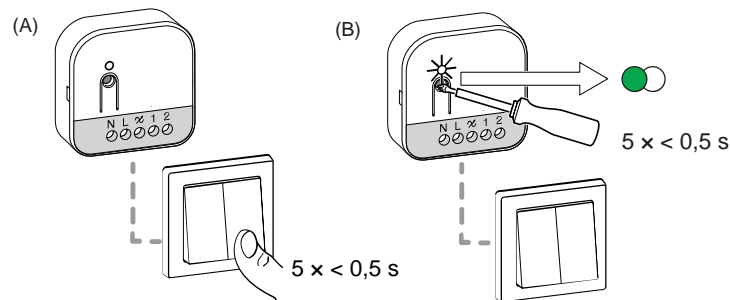

The light connected to the dimmer blinks for a few times. The dimmer can now be controlled by the push-button.

## Adjusting the brightness

You can set the minimum/maximum brightness of the dimmer.

**IMPORTANT:** Set the minimum/maximum brightness settings of the dimmer only after pairing it with Wireless switch. Refer [Pairing Wireless switch with Dimmer](#), page 9.

- To enter the dimmer settings mode, follow any one of the options:
  - Press and hold the Set (setup/reset) button on the device with a screwdriver for 15 s.
  - Press and hold the mechanical push-button for 15 s.

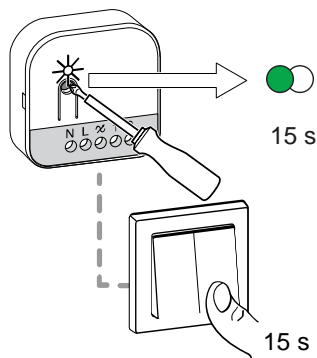

The dimmer LED blinks green and then the connected load blinks till the settings mode is confirmed.

- Proceed further to set the minimum/maximum brightness settings.

**NOTE:** Some lamps have a starting point. When the lamp is switched on at low brightness, it quickly becomes bright and then automatically returns to the lower brightness. This is the lamp's behavior and the dimmer cannot alter/change it.

The following demonstrations are shown with a mechanical push-button.

### Adjusting minimum brightness:

- Short press the mechanical push-button 2 times.

The connected load will reach the minimum brightness level.

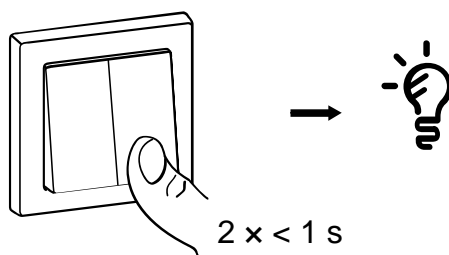

- Long press the mechanical push-button to set the minimum brightness of your choice.

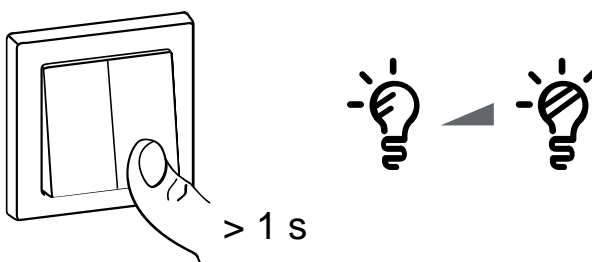

3. Wait for the time out for 30 s or short press the mechanical push-button 2 times to confirm the settings.

The connected load blinks for few times indicating that the setting is saved.

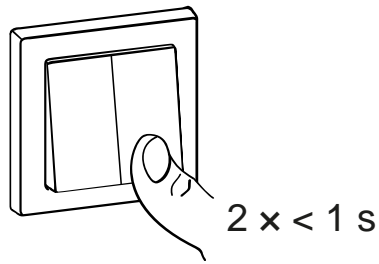

## Adjusting maximum brightness:

1. Short press the mechanical push-button 4 times.

The connected load will reach the current maximum brightness level.

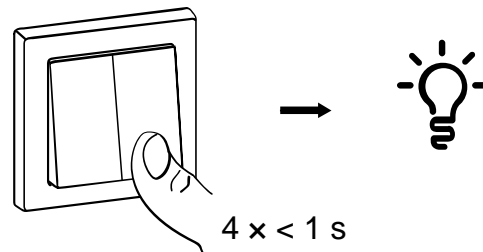

2. Long press the mechanical push-button, to set the maximum brightness of your choice.

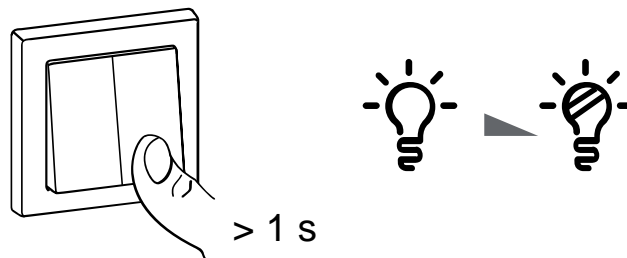

3. Wait for the time out for 30 s or short press the mechanical push-button 2 times to confirm the settings.

The connected load blinks for few times indicating that the setting is saved.

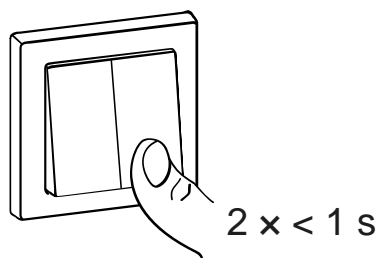

## Operating a dimmer in Quick Home Connect

You can switch the dimmer on/off or adjust its brightness using the paired Wireless switch.

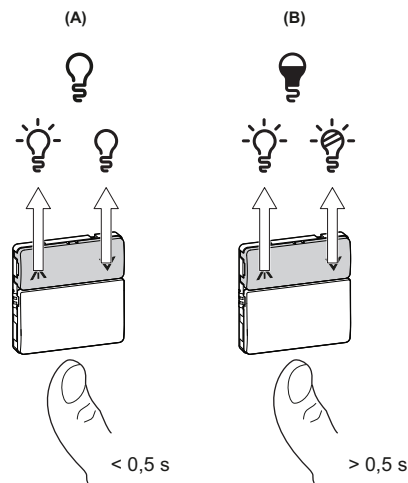

## Resetting the device in Quick Home Connect

It is necessary to reset the devices in the following scenarios:



- Unpair the device in Quick Home Connect:
  - Refer to [Resetting the Wireless switch](#).
  - Refer to [Resetting the Dimmer](#), page 47.

When reset is done successfully. The **Wireless switch** and device returns to **factory default**.

- **Integrating into Wiser System**
  - If you wish to integrate the devices into Wiser System, reset all the devices in Quick Home Connect and refer to [Pairing the device with Wiser Gateway](#), page 16.

## LED indications in Quick Home Connect

### Pairing the device in Quick Home Connect

User Action	LED Indication	Status
Press the push button 5 times in quick succession.	LED blinks green, once per second. 	Pairing mode is active for 60 seconds. When pairing is completed, LED stops blinking. 

## Troubleshooting in Quick Home Connect

Symptom	Possible cause	Solution
LED displays amber in dimmer.	Pairing not completed and returned to factory reset.	Pair the Wireless switch and the device again. Refer to Pairing Wireless switch with Dimmer, page 9.
Wireless switch not able to control the device reliably.	The Wireless switch and the device are too far away from each other.	Place the Wireless switch in a position closer to the device.
	The Wireless switch lost pairing.	Pair the device again <ul style="list-style-type: none"> <li>Refer to Pairing Wireless switch with Dimmer, page 9.</li> </ul>
	The Wireless switch battery is discharged.	Replace the battery of the Wireless switch.

Scenario	Procedure
Central control of multiple devices with Wireless switch.	If you wish to have a centralized control with a single Wireless switch, first pair the central control Wireless switch with devices and then pair the other Wireless switch with the remaining devices.

## Pairing the device with Wiser Gateway

Using the Wiser app, first pair your device with the **Wiser Gateway** to access and control the device. You can either add the device manually or do an auto-scan to pair it.

### Pairing device manually

To pair the device manually:

1. On **Home** page, tap **+**.
2. Tap  and select the **Wiser Hub** on the slide-up menu.
3. Select an option to add the device (A):
  - **Add Device with Install Code**
  - **Add Device without Install Code**

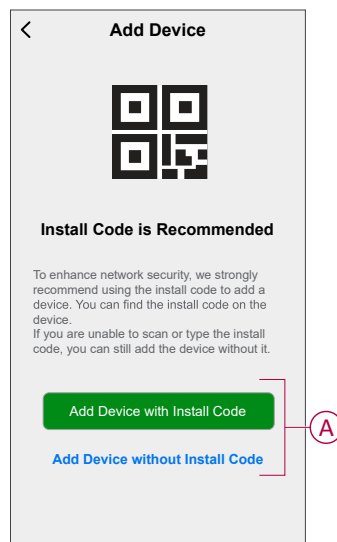

**TIP:** It is recommended to add the device with install code.

4. To pair the device with install code, tap **Add Device with Install Code** to display the slide-up menu. Select any one of the options (B):
  - **Scan Install Code:** you can scan the device for the install code.

**TIP:** You can find the QR code on the rear side of the device.
  - **Enter Install Code Manually:** you can manually enter the install code from the device.

**TIP:** You can find the install code on the rear side of the device.

After scanning or entering the install code, proceed to **Step 6**.

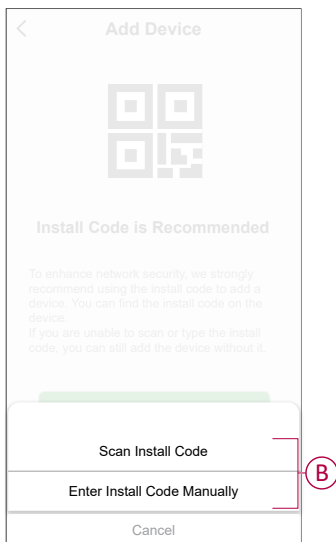

5. To pair the device without install code, tap **Add Device without Install Code**.
6. Select any of the following:
  - Short press the Set (setup/reset) button 3 times (<0,5 s) on the Puck with a screwdriver.
  - Short press the mechanical push button-1 for 3 times.

The LED blinks orange.

**NOTE:** If the device is located behind the push button, the status LED is not visible.

7. In the app, select **Confirm LED is flashing orange** and tap **Start configuration (C)**.

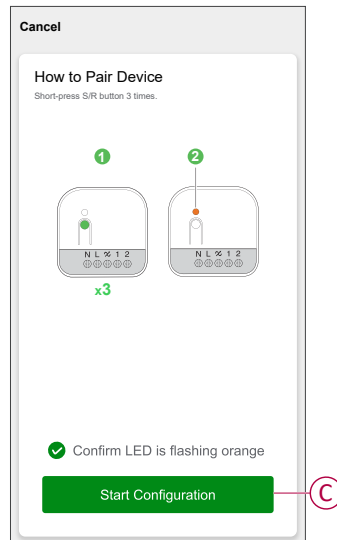

After a few seconds, a solid green LED indicates that the device is successfully paired to the Hub.

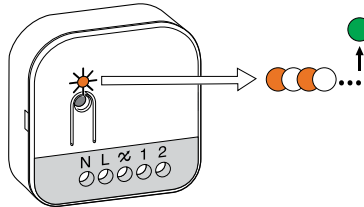

8. Once the device is added in the app, tap **Done**.

## Pairing device with auto scan

Pairing the device with auto scan automatically discovers the device when the corresponding device is powered on.

1. On the **Home** page, tap **+**.
2. Tap **Auto scan > Confirm**.
3. Enable permissions to **Access location** and **Wi-Fi** for scanning device and tap **Start scanning**.

**NOTE:** If you have multiple hubs, do Step 4 or proceed to Step 5.

4. Tap **Select hub** and select the **Wiser Hub** from the slide-up menu.
5. Short press the Set (setup/reset) or the mechanical push button-1 for 3 times (< 0,5 s). Wait for a few seconds until the device search is complete.

The LED blinks orange.

**TIP:** If you want to pair multiple devices at once, perform step 5 on each device and wait for a few seconds for them to be detected.

6. Tap **Next (A)** and select **Dimmer Micromodule**.

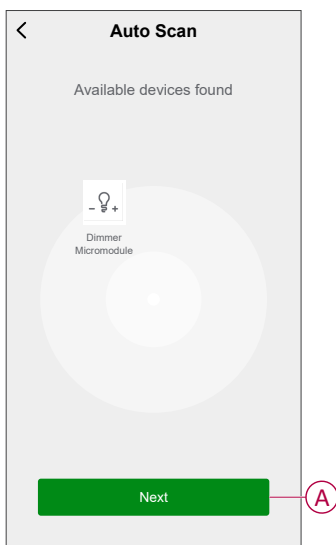

7. Once the device is added successfully, tap **Done**.

## Checking the type of wiring mode

Using the Wiser app, you can check whether the dimmer is connected with or without neutral wire.

1. On the **Home** page, tap **All devices** > **Dimmer Micromodule**.

2. Tap  and tap **Device information**.

You see the type of **wiring mode** (A) in the app.

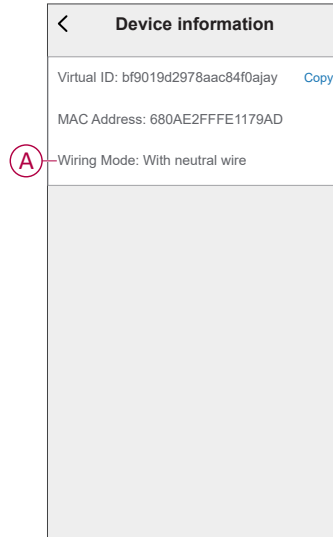



**NOTE:** Virtual ID and MAC address may vary with the device.

# Configuring the device

## Changing the device icon

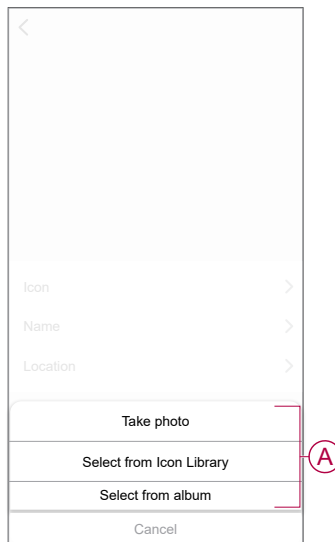

You can change the device icon using the Wiser app.

1. On the **Home** page, select the device for which you wish to change the icon.
2. At the top-right corner of the screen, tap .
3. Tap edit  next to the device name.
4. Tap **Icon** to view the menu.
5. In the slide-up menu, select any one of the following (A) to change the device icon:
  - **Take photo** - allows you to take a photo with your device camera.
  - **Select from Icon Library** - allows you to select an icon from the app library.
  - **Select from Album** - allows you to select a photo from the mobile gallery.



## Renaming the device

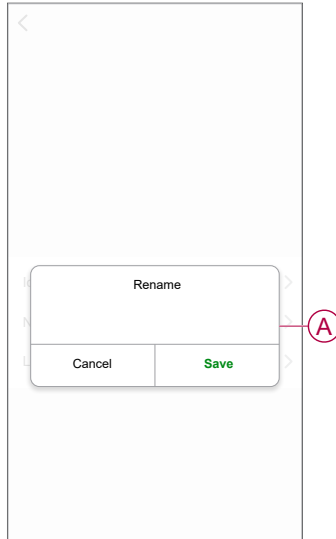

You can rename the device using the Wiser app.

1. On the **Home** page, select the device for which you wish to rename.
2. At the top-right corner of the screen, tap .
3. Tap edit  next to the device name.
4. Tap **Name**, enter the new name (A) and then tap **Save**.



## Changing the device location

You can change the device location using the Wiser app.

1. On the **Home** page, select the device for which you wish to change the location.
2. At the top-right corner of the screen, tap .
3. Tap edit  next to the device name.
4. Tap **Location**.
5. Select the desired location from the list (A) and then tap **Save**.

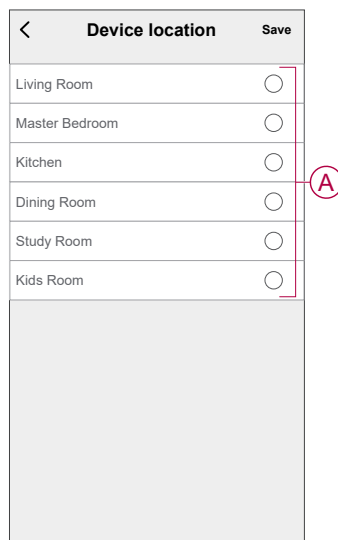

## Dimmer settings

Using the app, you can manage the Dimmer modes and settings.

To access the dimmer settings:

1. On the **Home** page, tap **All devices** > **Dimmer Micromodule**.
2. On the device control panel page, tap **Settings**.

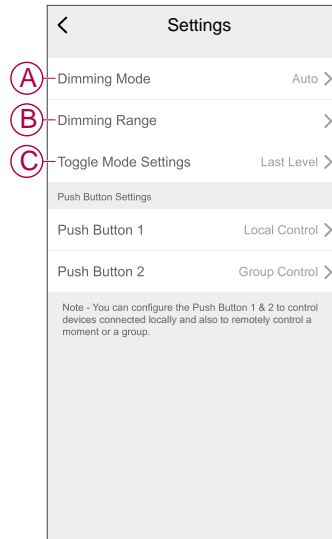

## Dimming mode

You can change the dimming mode in the app if you have problems with light flickering. This improves the dimming quality.

Tap **Dimming Mode (A)** and select either of the following:

- **RC** - When load is connected to the dimmer.
- **Leading Edge** - When a LED is connected to the dimmer. Only choose this mode if the LED is not working properly in RC mode.

**NOTE:** Leading Edge mode uses 10 % of the nominal load to avoid overheating of the Dimmer, refer to technical data, page 49.

## Dimming range

You can restrict the maximum and minimum brightness of the load connected to the device. This is done to avoid flickering and switching off the LED.

Tap **Dimming Range** (B) and do either or both of the following:

- **Min Brightness** - Drag the sliding bar to restrict the minimum brightness.

**NOTE:** When you slide the bar to the right to set the minimum brightness, the light maintains the minimum brightness level, even if you drag the sliding bar to the lowest value in the control panel, page 25.

- **Max Brightness** - Drag the sliding bar to restrict the maximum brightness.

**NOTE:** When you slide the bar to the left to set the maximum brightness, the light maintains the maximum brightness level, even if you drag the sliding bar to the highest value in the control panel, page 25.

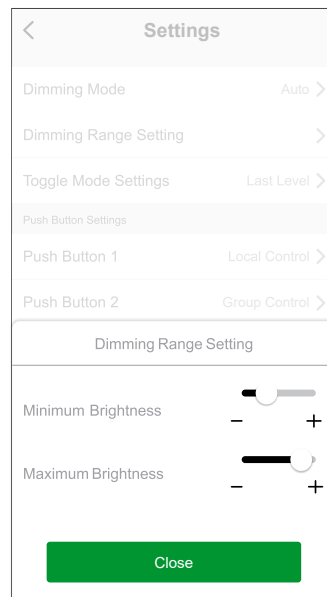

**TIP:** You can also adjust the dimming range by pressing the +/- buttons below the sliding bar.

## Toggle mode setting

Using this setting, the device will remember the last state of the device.

Tap **Toggle Mode Setting** (C) and select any one of the following:

- **100%** - The LED glows at maximum brightness every time it is turned on.
- **Last Level** (Memory Function) - The LED glows at the previously set brightness level whenever it is turned on.

## Using the device

The Control Panel allows you to switch the Dimmer on/off, increase/decrease the brightness and control various settings.

On the **Home** page, tap **All devices** > **Dimmer Micromodule** to access the control panel.

On the control panel page, you can see the following:

- The current state of the Dimmer (A)
- Sliding bar to adjust the brightness (B)
- The current brightness percentage (C)
- Schedule, page 28 (D)
- Settings, page 23 (E)

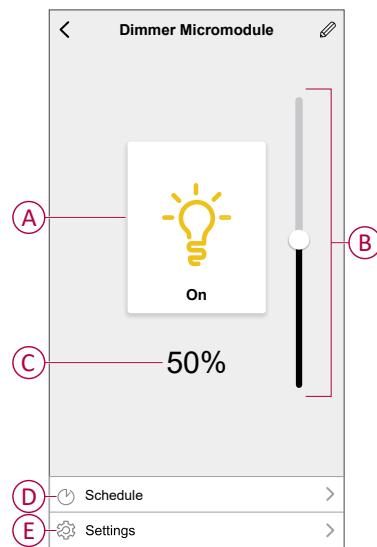

## Manual operation

When the Puck is connected to a mechanical push button, the connected lighting devices can be controlled manually.

- Short press the mechanical push button-1 to turn on/off the light.
- Press and hold the mechanical push button-1 to adjust the dimming level of the light.

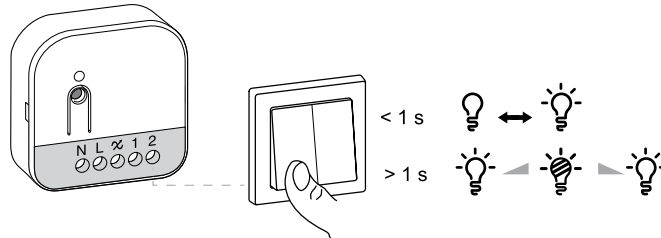



**NOTE:** Some lamps have a starting point. When the lamp is switched on at low brightness, it quickly becomes bright and then automatically returns to the lower brightness. This is the lamp's behavior and the dimmer cannot alter/change it.

## Adjusting the brightness level using app

Using the , you can increase/decrease the brightness level remotely. To increase/decrease the brightness level:

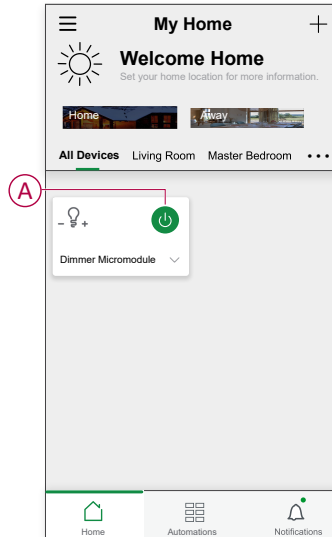
1. On the **Home** page, tap **All devices**.
2. In **Dimmer Micromodule** tap the power button (A) to turn on/off the device.



3. Tap  for slide-up menu.

4. In the slide-up menu, drag the sliding bar (B) to increase/decrease the brightness.

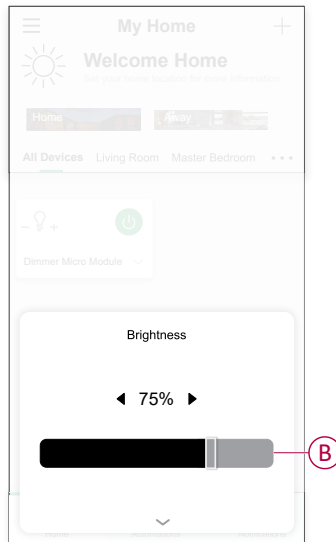

5. Alternatively, you can navigate to device menu and tap on (C) to turn on/off the device. When the device is turned on, drag the sliding bar (D) up/down to increase/decrease the brightness.

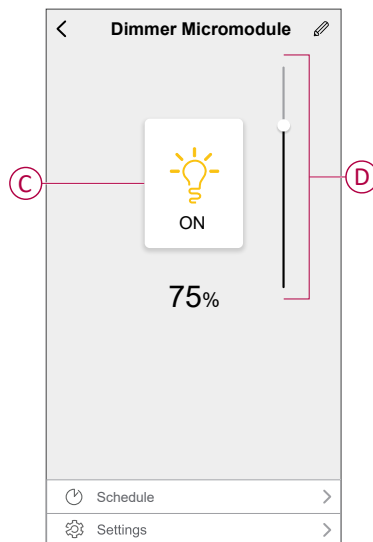

**NOTE:** Some lamps have a starting point. When the lamp is switched on at low brightness, it quickly becomes bright and then automatically returns to the lower brightness. This is the lamp's behavior and the dimmer cannot alter/change it.

## Setting up a schedule

The device can be fully controlled by a schedule. Once the schedule is set, the device operates at a given time.

1. On the **Home** page, Tap **All devices > Dimmer Micromodule**.
2. Tap **Schedule > Add Schedule** to add a schedule.
3. In **Add Schedule** menu, set the time (A).

**NOTE:** The Schedule works according to the time zone where the device is located.

4. Tap **Repeat** (B) to select the days you want to set the schedule.
5. Tap **Note** (C), enter the note and tap **Confirm**.
6. Tap the toggle switch (D) to turn on the **Notification** for the schedule. The app will send a notification that the scheduled task is executed at the time of schedule.
7. Adjust the **Brightness settings** (E) through sliding bar.

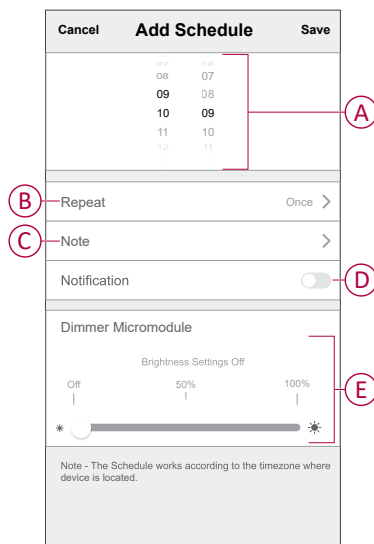

8. Tap **Save**

## Push button control

Using the app, you can configure the Push Button to control devices connected locally and also to remotely control a moment or a group.

To access push button control settings:

1. On the **Home** page, tap **All devices** > **Dimmer Micromodule**.
2. On the device control panel page, tap **Settings**.
3. Select the push button which you want to configure.
  - **Push Button 1**
  - **Push Button 2**
4. On the slide-up menu select any one of the following:
  - **Group Control**
  - **Moment**
  - **Local Control**

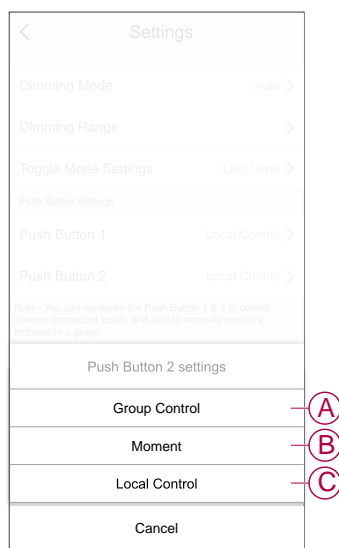



## Group control

A group allows you to trigger set of device action at the same time that are usually performed together. Using the app, you can create group based on your needs (such as bed time).

### Creating a group

1. Select **Group Control** in the slide-up menu and then tap **+** to create a new group.

2. Tap **Edit name** , enter the group name (A) and tap **Save**.

**TIP:** You can choose the cover image that represents your group by tapping .

3. In the **Action** section, tap **Add task** to open the slide-up menu.

4. Select the dimmers which you want to add in the group and tap **Next**.

**TIP:** You can add one or more actions using .

5. Tap **Save** to verify and save the group.

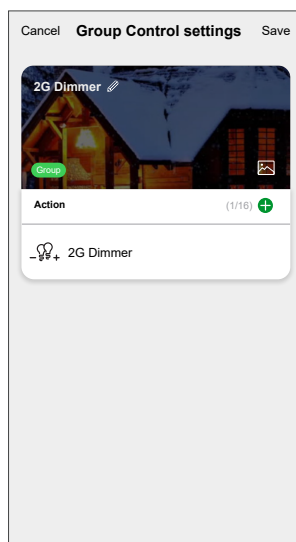

## Adding a group

In Group Control page, tap on the group to save the to save the settings.

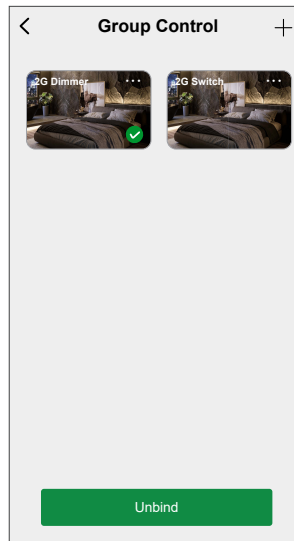

## Editing a group

1. In Group Control page, locate the group you want to edit and tap ●●●.
2. On the **Edit** page, you can tap each item to change the settings and tap **Save**.

### TIP:

- You can add one or more actions using .
- To delete an existing action, slide each item towards left and tap **Delete**.

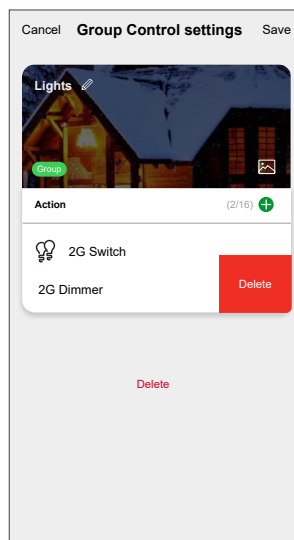

## Unbinding a group

1. In Group Control page, tap on the group you want to unbind.
2. Tap **Unbind** to remove the group assigned to a push button setting.

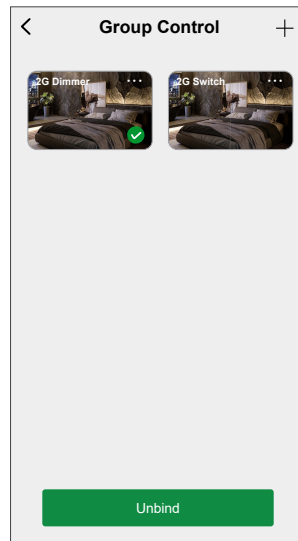

## Deleting a lighting group

1. In Group Control page, locate the group you want to delete and tap ●●●.
2. Tap **Delete**.

**NOTE:** Deleting a group will unbind the group from push button setting.

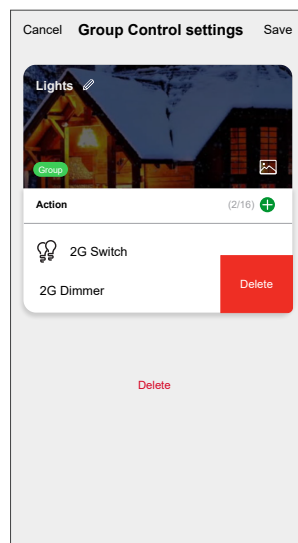

## Push button moment control

A Moment allows you to group multiple actions that are usually performed together. Using the app, you can create moments based on your needs (such as movie night) and configure them to the Wireless Switch push buttons.



### Creating a moment for push button

1. Select **Moment Control** in the slide-up menu.
2. Select **Moment 1** or **Moment 2**

**NOTE:**

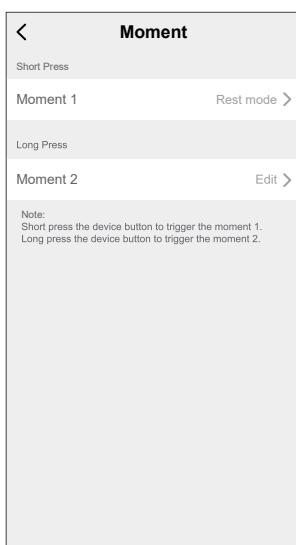
- Short press the push button to trigger the Moment 1.
- Long press the push button to trigger the Moment 2.



3. On **Moment** page tap **+** to create a new moment.
4. Tap **Edit name**  , enter the moment name (A) and tap **Save**.  
**TIP:** You can choose the cover image that represents your moment by tapping .
5. In the **Action** section, tap **Add task** to open the slide-up menu.
6. Select the dimmers which you want to add in the moment and tap **Next**.

**TIP:** You can add one or more actions using .

7. Tap **Save** to verify and save the moment.

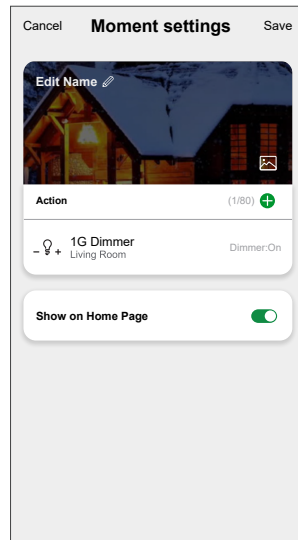

## Assigning moment to push button

In Moment Control page, tap on the moment to save the to save the settings.

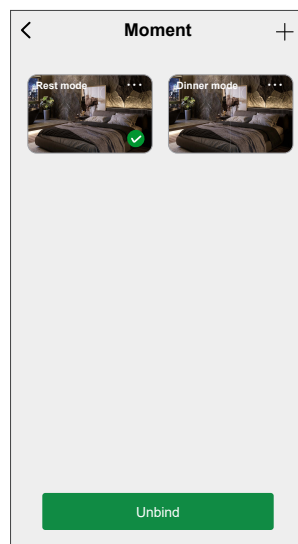

## Editing a push button moment

1. In Moment Control page, locate the moment you want to edit and tap ●●●.
2. On the **Edit** page, you can tap each item to change the settings and tap **Save**.

**TIP:**

- You can add one or more actions using .
- To delete an existing action, slide each item towards left and tap **Delete**.

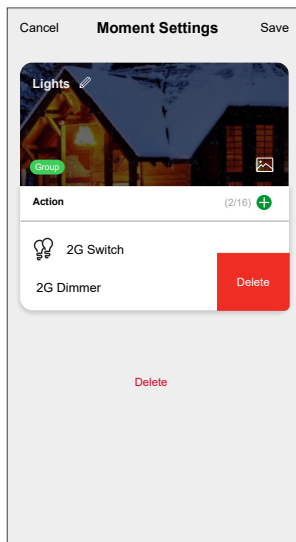

## Unbinding a moment from Push button

1. In Moment Control page, tap on the moment you want to unbind.
2. Tap **Unbind** to remove the moment assigned to a push button setting.

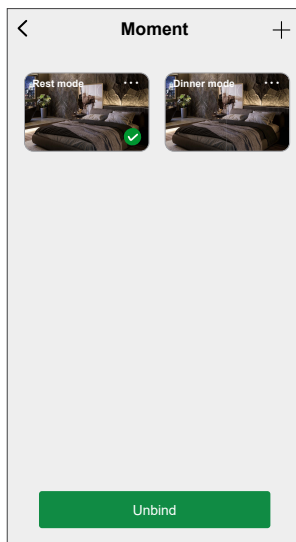

## Deleting a lighting moment

1. In Moment Control page, locate the moment you want to delete and tap ●●●.
2. Tap **Delete**.

**NOTE:** Deleting a moment will unbind the moment from push button setting.

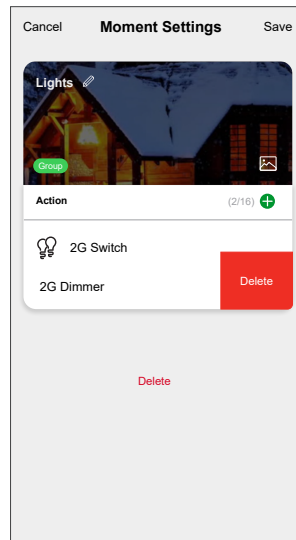

## Local control

You can set the push button switch action to control the load locally.

1. Select **Local Control** in the slide-up menu.
2. Select one of the option based on your requirement:
  - **Turn On, Dim Up**
  - **Turn Off, Dim Down**
  - **Turn On/Off, Dim Up/Down**

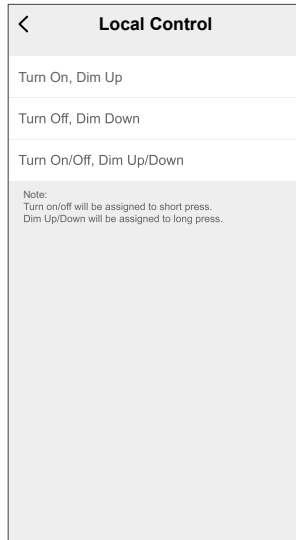



### NOTE:

- Turn on/off will be assigned to short press..
- Dimming up/down will be assigned to long press

## Creating a moment

A Moment allows you to group multiple actions that are usually done together. Using the Wiser app, you can create moments based on your needs.

1. On the **Home** page, tap .
2. Go to **Moment** > **+** to create a moment.
3. Tap **Edit name**  (A), enter the name of the moment and tap **Save**.  
**TIP:** You can choose the cover image that represents your moment by tapping .

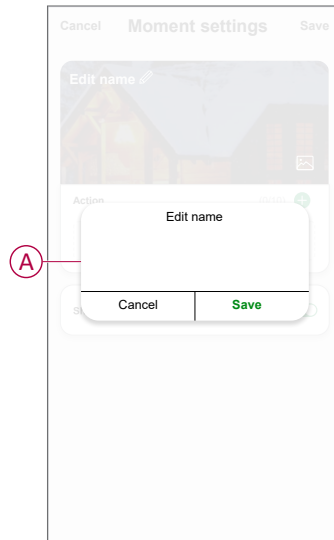

4. In the **Action** section, tap **Add task** (B) to open the slide-up menu.
5. In the **Add task** menu, you can do either or all of the following actions (C):
  - **Run the device:** select the devices that you want in a moment.
  - **Select Automation:** select the automation that you want to enable or disable.
  - **Delay:** set the delay time.

**NOTE:** You can add one or more actions using .

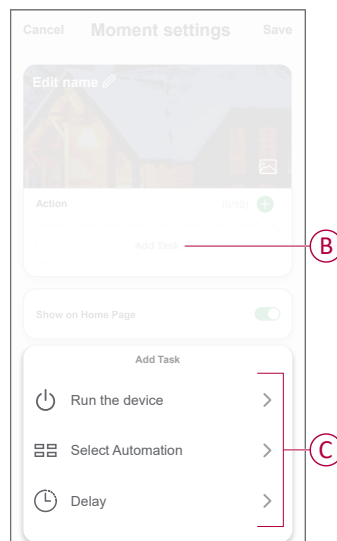

6. Tap **Run the device > Dimmer Micromodule** to select either or all the functions to add in the moment:
  - **Dimmer (D)**: to turn on/off the device.
  - **Brightness (E)**: to set the percentage of brightness required.

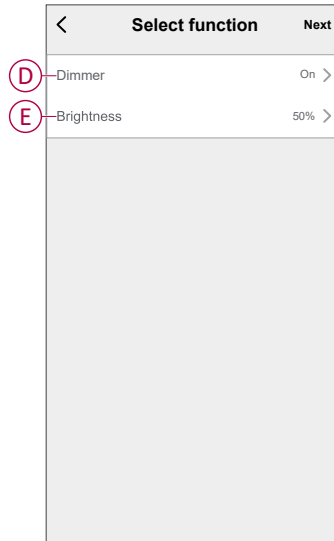

7. Tap **Next** and once the actions are set, tap **Save**.

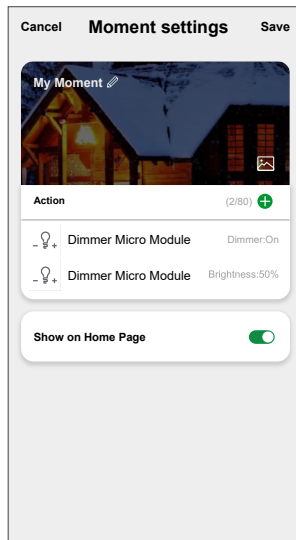

## Editing a moment

1. On the **Moment** tab, locate the moment you want to edit and tap ●●●.
2. On the **Edit** page, you can tap each item (such as dimmer, shutter, delay, temperature, etc.) to change the settings.

**TIP:**

- You can add one or more actions using .
- To delete an existing action, slide each item towards left and tap **Delete**.

## Deleting a moment



To delete a moment:

1. On the **Moment** tab, locate the moment that you want to delete and then tap ●●●.
2. Tap **Delete** and then tap **Ok**.

**NOTE:** After deleting a moment, the device action can no longer be triggered.

## Creating an automation

An automation allows you to group multiple actions that are usually done together, triggered automatically or at scheduled times. By using the Wiser app, you can create automations based on your needs.

1. On the **Home** page, tap the .
2. Go to **Automation** > **+** to create an automation.
3. Tap **Edit name**  (A), enter the name of the automation and tap **Save**.  
**TIP:** You can choose the cover image that represents your automation by tapping .

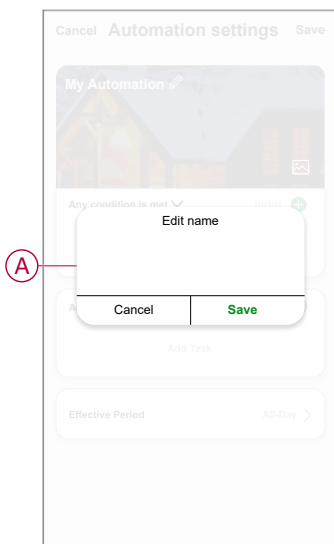

4. Tap **Any condition is met** to select any one of the condition type (B):
  - **All conditions are met:** the automation is triggered when all the conditions are met.
  - **Any condition is met:** the automation is triggered when at least one condition is met.

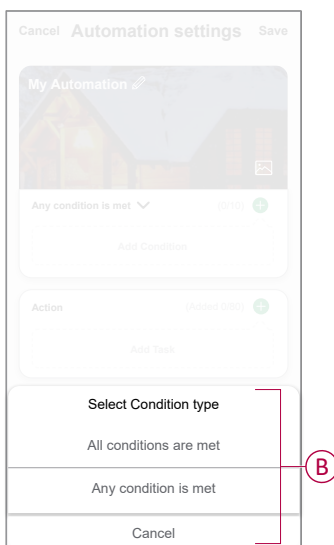

5. Tap **Add Condition** to open the slide-up menu.

6. In the **Add Condition** menu, you can do either or all of the following options (C):
- **When weather changes:** select the various weather settings.
  - **Schedule:** set the time and day.
  - **When device status changes:** select the device and it's function.

**NOTE:** You can add one or more conditions using .

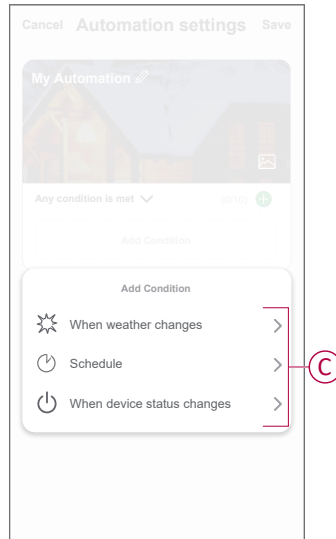

7. Tap **When device status changes > Dimmer Micromodule** and select either or both the functions:

- **Dimmer:** turn the Dimmer on/off (D).
- **Brightness:** adjust the brightness level (E).

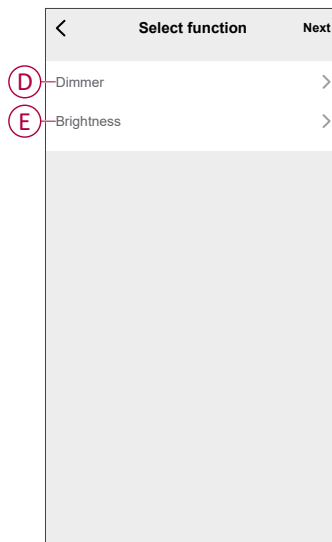

8. Tap **Add task** to open the slide-up menu.

9. In the **Add task** menu, you can do either or all of the following options (F):
  - **Run the device:** select the devices that you want to trigger.
  - **Moment or Automation:** select the moment which you want to trigger or select the automation that you want to enable or disable.
  - **Send notification:** turn on notification for the automation.
  - **Delay:** set the delay time.

**NOTE:** You can add one or more actions using .

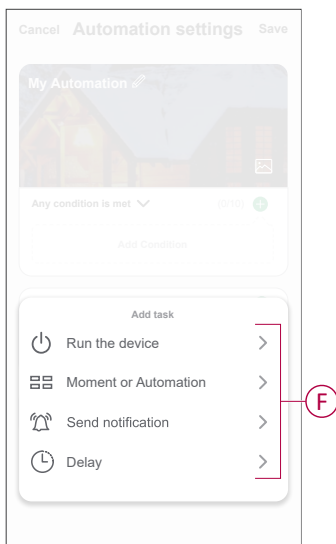

10. Tap on **Effective period** to set the time range for the automation. You can select any one of the following (G):
  - **All-day** - 24 hours
  - **Daytime** - From sunrise to sunset
  - **Night** - From sunset to sunrise
  - **Custom** - User defined time period

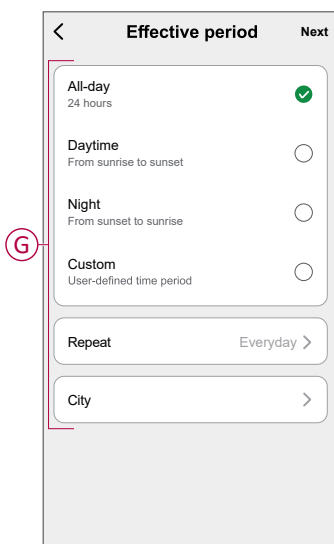

11. Set all the actions and conditions and tap **Save**.  
Automation is now available under **Automation** tab. Use toggle switch to enable/disable automation.

## Example of an automation

This demonstration shows you how to create an automation to turn on the dimmer at the scheduled time.

1. Go to **Automation** > **+** to create an automation.
2. Tap **Edit name**, enter the name of the automation and tap **Save**.  
**TIP:** You can choose the cover image that best represents your automation by tapping .
3. Tap **Add Condition** > **Schedule**.
  - Tap **Repeat** (A), select the days you want to set the schedule and tap **Save**.
  - Set the time (B) at which the automation must start and tap **Next**.

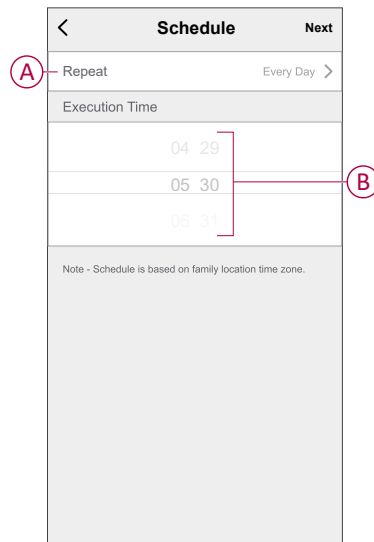

4. Tap **Add task** > **Run the device** > **Dimmer Micromodule**.
5. Tap **Dimmer** (C) and in the slide-up menu, select **On** and tap **Save**.
6. Tap **Brightness** (D) and update the required brightness level and tap **Save**.

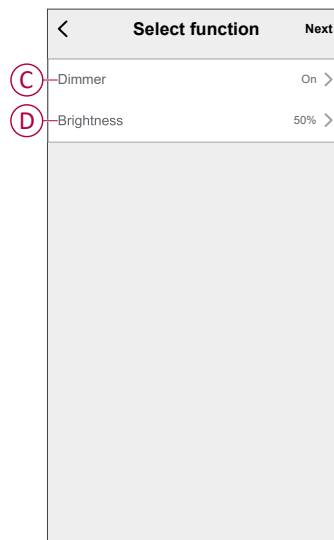

7. Tap **Next**.

- In the **Automation Settings** page, tap **Save**.

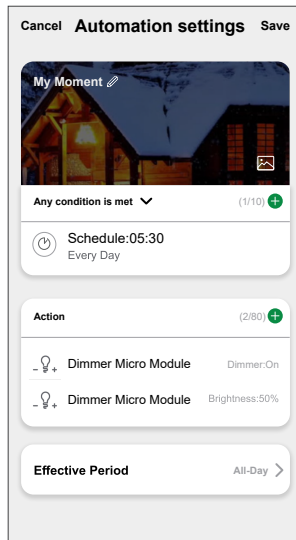

Once the automation is saved, it is visible on the **Automation** tab. You can tap the toggle switch on the automation to enable it.

## Editing an automation

- On the **Automation** tab, locate the automation you want to edit and tap ●●●.
- On the **Edit** page, you can tap each item (such as dimmer, shutter, delay, temperature, etc.) to change the settings.

### TIP:

- You can add one or more condition or actions using .
- To delete an existing condition or action, slide each item towards left and tap **Delete**.

## Deleting an automation

- On the **Automation** tab, locate the automation that you want to delete and then tap ●●●.
- Tap **Delete** and then tap **Ok**.

**NOTE:** After deleting an automation, the device action can no longer be triggered.

## Removing the device

Using the Wiser app, you can remove a device from the device list. To remove the device:

1. On the **Home** page, tap **All devices** > **Dimmer Micromodule**.
2. Tap  to display more details.
3. Tap **Remove and Factory Reset Device (A)**.

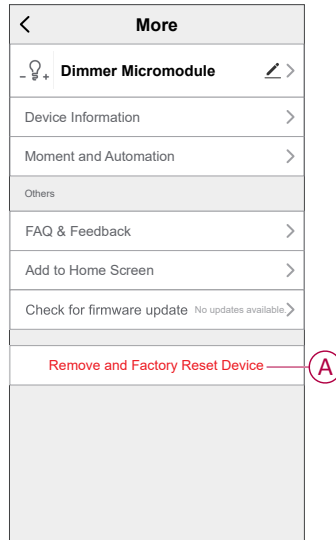

**TIP:** On the **Home** page, tap and hold the **Dimmer Micromodule** to remove the device.

**NOTE:**

- Removing the device will reset the device. After reset the LED turns orange indicating that the device is ready to pair with another network.
- If there is a problem while pairing or resetting the device, refer to Resetting the device manually, page 47.

## Resetting the device

You can reset the device to factory default manually.

1. Short press the Set (Setup/Reset) button 3 times ( $< 0.5$  s) and then long press the Set (Setup/Reset) button once ( $> 10$  s).

or

Short press the mechanical push button-1 for 3 times and then long press the push button once for 10 s.

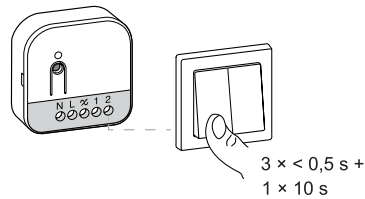
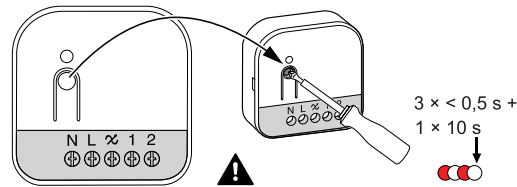

2. After 10 s, LED starts blinking red, then release the push-button.



**NOTE:** All configuration data, user data, and network data are deleted.  
After which

- No connectivity to other devices or rooms.
- Memory function is active.
- Dimmer settings will reset to default.



The LED stops blinking upon successful reset of the device.  
The device restarts and blinks green for a few seconds.

## LED indication

### Pairing the device

User Action	LED Indication	Status
Short press the setup/reset button or push button 3 times.	LED blinks orange once per second. 	Pairing mode is active for 30 seconds. When pairing is completed, LED glows green for a few seconds before turning off. 

### Resetting the device















User Action	LED Indication	Status
Short press the setup/reset button or push button 3 times and hold it down once for > 10 s.	LED blinks red once per second. 	The device is in reset mode. The device then restarts and LED turns orange indicating that the device is ready for pairing. 

## Troubleshooting

Symptom	Solution
Dimming up not possible.	<ul style="list-style-type: none"> <li>Reduce/increase load.</li> <li>Allow the puck to cool in case of overheating.</li> <li>Change the load (if the load is incompatible with the puck).</li> </ul>
Switching on not possible.	<ul style="list-style-type: none"> <li>Allow the puck to cool in case of overheating.</li> <li>Reduce load.</li> <li>Change load.</li> <li>Check wiring between the push button and the puck.</li> </ul>
Flickering at minimum brightness.	<ul style="list-style-type: none"> <li>Increase minimum brightness (if flickering still persists, install a 31 LCDA load correction device).</li> <li>Change the load (if the minimum brightness is insufficient).</li> <li>Set RL LED mode (it is advised to use 10 % of nominal load to avoid overheating of the puck).</li> </ul>
Flickering	<ul style="list-style-type: none"> <li>Change load.</li> <li>Set RL LED mode (it is advised to use 10 % of nominal load to avoid overheating of the puck).</li> </ul>
Only slight dimming capability	<ul style="list-style-type: none"> <li>Change dimming range.</li> <li>Set RL LED mode (it is advised to use 10 % of nominal load to avoid overheating of the puck).</li> <li>Change the load (if the load is incompatible with the puck).</li> </ul>
The device is not ready to pair after the device is removed from the app.	Reset to factory default settings, refer to <a href="#">Resetting the device manually</a> , page 47.

## Technical data

### Nominal power

Load type	Load name	Load value	
		2 wire (without neutral)	3 wire (with neutral)
	LED	5 - 200 W (max. 0.8 A)  5 - 80 W (max. 0.5 A) 	0 - 200 W (max. 0.8 A)  0 - 80 W (max. 0.5 A) 
	Incandescent lamp	20 - 300 W 	0 - 300 W 
	Electronic step-down converter	20 - 300 VA 	0 - 300 VA 
	Halogen lamp	20 - 300 W 	20 - 300 W 

<b>Nominal voltage</b>	AC 230 V, 50 Hz	
<b>Dimming channel</b>	1	
<b>Standby</b>	< 0.25 W	
<b>Operating Temperature</b>	- 5 °C to 35 °C	
<b>Neutral conductor</b>	Recommended	
<b>Connecting terminals</b>	Tightening torque	0.5 Nm
	Solid conductor	1 x 0.75 - 2.5 mm <sup>2</sup>
	Stranded conductor intended for fixed installation:	1 x 0.75 - 2.5 mm <sup>2</sup>
<b>Extension connection</b>	Max. 10 mechanical push buttons	
<b>Length of all cable sections</b>	Max. 50 m for 3-wire NYM cable	
<b>Fuse protection</b>	16 A circuit breaker	
<b>Operating frequency</b>	2405 - 2480 MHz	
<b>Max. radio-frequency power transmitted</b>	<10 mW	
<b>IP rating</b>	IP20	
<b>Product dimensions (H x W x D)</b>	45 x 45 x 18.4 mm	
<b>Communication protocol</b>	Zigbee 3.0 certified	

# Compliance

## Compliance information for Green Premium products

Find and download comprehensive information about Green Premium products, including RoHS compliance and REACH declarations as well as Product Environmental Profile (PEP) and End-of-Life instructions (EOLI).

<https://checkaproduct.se.com/>



## General information about Green Premium products

Click the link below to read about Schneider Electric's Green Premium product strategy.

<https://www.schneider-electric.com/en/work/support/green-premium/>



## EU Declaration of Conformity

Hereby, Schneider Electric Industries, declares that this product is in compliance with the essential requirements and other relevant provisions of RADIO DIRECTIVE 2014/53/EU. Declaration of conformity can be downloaded on [se.com/docs](http://se.com/docs).

## Trademarks

This guide makes reference to system and brand names that are trademarks of their relevant owners.

- Zigbee® is a registered trademark of the Connectivity Standards Alliance.
- Apple® and App Store® are brand names or registered trademarks of Apple Inc.
- Google Play™ Store and Android™ are brand names or registered trademarks of Google Inc.
- Wi-Fi® is a registered trademark of Wi-Fi Alliance®.
- Wiser™ is a trademark and the property of Schneider Electric, its subsidiaries and affiliated companies.

Other brands and registered trademarks are the property of their respective owners.

Printed in:  
Schneider Electric  
Lautrupvang 1  
2750 Ballerup  
Denmark  
+45 88 30 20 00

Schneider Electric Danmark A/S  
Lautrupvang 1, 2750 Ballerup

Danmark

+45 88 30 20 00

[www.lk.dk](http://www.lk.dk)

As standards, specifications, and design change from time to time,  
please ask for confirmation of the information given in this publication.

© 2024 – 2024 Schneider Electric. All rights reserved.

DUG\_Multiwire Puck Dimmer\_LK-00