

For a rigid wall or ceiling fastening of a clip by means of a threaded rod/pipe.

Advantages

- Slotted holes for fixing.
- Can also be used in fixed point constuctions, in combination with KB clips or RSF clips.

Technical Specifications

- Electrolytically zinc plated.



Description	Flamco backplate GP M8 x 80x30	
Order Code	39417	
GTIN	08712874394179	
Model	<u>GP Backplates 80 x 30</u>	
Connection	M 8	
Dimensions	A [mm]	54
	B [mm]	30
	H [mm]	80
	D [mm]	11
	E [mm]	3
	Slotted hole [mm]	9 x 16

*Also available in stainless steel (Inox V 4 A, 1.4435).

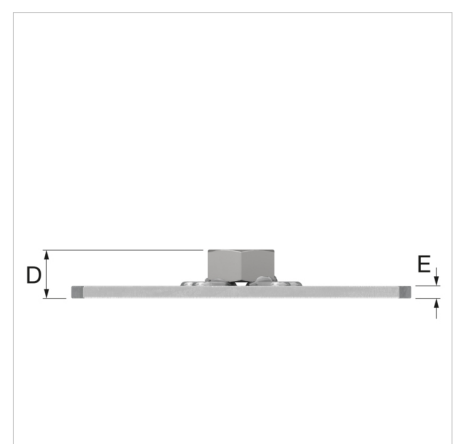
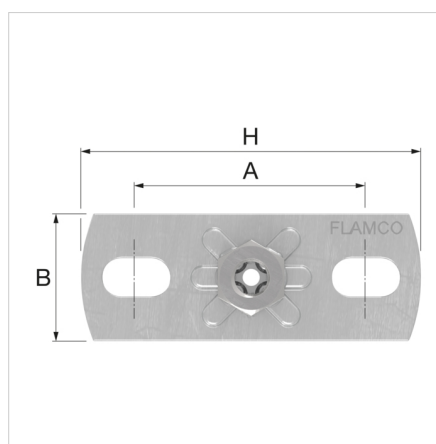



Classification General Data

Etim Group	Fasteners
Etim Class	Base plate for bracket attachment
Product Name	FlamcoFix backplate GP M8 x 80x30
Brand	FLAMCO
Product Type	Backplates
Order Code	39417
GTIN	08712874394179

Attributes

Material	Steel
Surface protection	Galvanic/electrolytic zinc plated
Layer thickness surface protection	13 Micrometre
Shape	Other
Connection facility	Internal thread metric
Connection size, connection facility	M8
Number of mounting holes	2
Centre distance of connection facilities adjustable	No
Number of connection facilities	1
Width	30 Millimetre
Thickness	3 Millimetre
Length	80 Millimetre

Find more information online:

[Max. load on threaded rod & tube](#)

[Packaging data](#)