

FIBOX

Enclosing innovations



Fibox Gade- og Teknikskabe

FIBOX GADE- OG TEKNIKSKEBE 2012

Fibox designer og producerer kapslinger, som er velegnet til indkapsling og beskyttelse af udstyr, som skal placeres selv under udsatte og krævende omgivelser.

Sidste skud på stammen af kapslinger fra Fibox er Gade- og Teknikskebe.

Serien er fremstillet i vedligeholdelses- og halogenfrit glasfiberforstærket polyester, som kan indpasses diskret i alle former for miljøer. Et robust og moderne system, der er udviklet på basis af mange års erfaring og knowhow.

Fibox standard Gade- og Teknikskebeprogram er designet til at spare tid ved montage og installation og kan anvendes til følgende applikationer:

- Almindelige sikringsskebe
- Kabelfordelingssystemer
- Målerskebe
- Styreskebe til spildevands- og pumpestyringer
- Styresystemer til trafikregulering
- Gadebelysningsanlæg
- Tele- og bredbåndsinstallationer
- Kabel – TV installationer
- Gas- og fjernvarmeinstallationer
- Industrielle automatiseringssystemer
- Byfornyelsesprojekter
- Markedspladser og campingpladser fordelingsanlæg
- Torve- og gågadeløsninger
- Havne og kystnære miljøer

Fibox er din partner til alle opgaver med indkapsling. Sammen gør vi jeres ideer og innovation til en succeshistorie. For at sige det enkelt, vi indkapsler din innovation.

Vore generelle salgs- og leveringsbetingelser findes også på www.fibox.dk

Med venlig hilsen
Fibox A/S

COPYRIGHT FIBOX A/S

Af hensyn til katalogets opbygning og overskuelighed har vi valgt at anføre de vigtigste data for det enkelte produkt.

Ønskes en mere dybdegående teknisk information henvises til www.fibox.dk.

Der tages forbehold overfor eventuelle fejl, mangler og ændringer. Grafisk tilrettelæggelse, produktion og copyright:

Fibox A/S. Vi gør opmærksom på, at det benyttede tegnings- og billedmateriale tilhører Fibox.

FIBOX

Enclosing innovations

ST - 2642	3
ST - 2658	4
ST - 2684	5
ST - 4042	6
ST - 4058	7
ST - 4084	8
ST - 4088/32	9
ST - 5342	10
ST - 5358	11
ST - 5384	12
ST - 5388/32	13
ST - 6644	14
ST - 6657	15
ST - 6688	16
ST - 6688/32	17
ST - 8042	18
ST - 8058	19
ST - 8084	20
ST - 8088/32	21
ST - 53+5388/32	22
ST - 66+4088/32	23
ST - 66+5388/32	24
ST - 80+4088/32	25
ST - 80+5388/32	26
ST - 80+8088/32	27
Fælles tilbehør	28
Måltegninger	29-33



Gadeskabsserien er fremstillet i polyester.

Vedligeholdelses- og halogenfrit produkt, som kan indpasses i alle former for miljøer.





Serien kan anvendes som almindelige sikringsskabe, kabelfordelingsskabe, styreskabe til spildevandspumpestyringer, trafikreguleringsskabe og ikke mindst til tele- og bredbåndsininstallationer.

ST serien er designet til at spare tid ved montage og installation.

Egenskaber:





- Let at lave montage i
- Flere valgmuligheder i løsninger, med og uden sokkel
- Korrugeret overflade, som virker forstærkende og anti graffiti
- Naturlig god ventilation og 180 graders døråbning
- Skinne- og sikringssystemer kan leveres som standard
- Mulighed for plombering samt adskillige låsesystemer
- Standardfarve, RAL7035
- Halogenfri bestanddele
- Opbygget efter EN 60439
- Tæthedsklasse IP 44
- Slagstyrketestet til IK 10 efter EN 62262
- Særdeles god UV resistent testet efter UL746C
- Isolationsspænding 500V
- Nominel strømstyrke 630 Amp.
- Dobbelt isoleret
- Brændbar kategori FH2-25
- Glødetrådstestet til 960 grader efter IEC 695-2

ST - 2642

	Typenr.	El-nr.	EAN-kode	Pakn. str.	Beskrivelse
	STCP 2642	82.12.046.171	 6.418.074.034.793	1	Gadeskab med sokkel STCP 2642 Skab HxBxD: 420x265x250 mm. Højde incl. sokkel: 1275 mm, IP44
	STC 2642	82.12.046.003	 6.418.074.032.959	1	Gadeskab uden sokkel STC 2642 Skab HxBxD: 420x265x250 mm. indvendig dybde 225 mm, IP44

ST - 2642 tilbehør

	Typenr.	El-nr.	EAN-kode	Pakn. str.	Beskrivelse
	MPF 2642	82.12.046.948	 6.418.074.041.784	1	Montageplade MPF 2642 10 mm. opskummet Forex plade Størrelse 230 x 360 mm.
	MPI 2642	82.12.046.650	 6.418.074.038.531	1	Montageplade MPI 2642 4 mm. pvc plade. størrelse 230x360 mm.
	MPS 2642	82.12.046.812	 6.418.074.041.609	1	Montageplade MPS 2642 2 mm. elforsinket stål plade Størrelse 230x360 mm.
	SMP 42/84	82.12.046.566	 6.418.074.036.711	1	Sideprofil for montageplade for højde 42/84
	STP 2642	82.12.046.362	 6.418.074.035.707	1	Gadeskabs sokkel STP 2642 HxBxD 855x265x250 mm. IK10
	CHP 26	82.12.046.456	 6.418.074.041.388	1	Metal Profil for kabel holder CHP 26
	CBB 26	82.12.047.329	 6.418.074.041.562	1	kobber skinne STCP/STC str 26 Maks 400 A Størrelse 40x5, længde 172 mm.

	Typenr.	El-nr.	EAN-kode	Pakn. str.	Beskrivelse
	STCP 2658	82.12.046.184	 6.418.074.034.809	1	Gadeskab med sokkel STCP 2658 Skab HxBxD: 580x265x250 mm. Højde incl. sokkel: 1435 mm., IP44
	STC 2658	82.12.046.016	 6.418.074.032.973	1	Gadeskab uden sokkel STC 2658 Skab HxBxD: 580x265x250 mm. indvendig dybde 225 mm., IP44

ST - 2658 tilbehør





	Typenr.	El-nr.	EAN-kode	Pakn. str.	Beskrivelse
	MPF 2658	82.12.046.951	 6418074041791	1	Montageplade MPF 2658 10 mm. opskummet Forex plade Størrelse 230x520 mm.
	MPI 2658	82.12.046.663	 6.418.074.038.548	1	Montageplade MPI 2658 4 mm. pvc plade størrelse 230x520 mm.
	MPS 2658	82.12.046.825	 6.418.074.041.616	1	Montageplade MPS 2658 2 mm elforsinket stål plade Størrelse 230x520 mm.
	SMP 58	82.12.046.595	 6.418.074.037.992	1	Sideprofil for montageplade for højde 58
	STP 2642	82.12.046.362	 6.418.074.035.707	1	Gadeskabs sokkel STP 2642 HxBxD 855x265x50 mm. IK10
	CHP 26	82.12.046.456	 6.418.074.041.388	1	Metal Profil for kabel holder CHP 26
	CBB 26	82.12.047.329	 6.418.074.041.562	1	køber skinne STCP/STC str 26 Maks 400 A Størrelse 40x5, længde 172 mm.

	Typenr.	El-nr.	EAN-kode	Pakn. str.	Beskrivelse
	STCP 2684	82.12.046.197	 6.418.074.0348.54	1	Gadeskab med sokkel STCP 2684 Skab HXBXD: 840x265x250 mm. Højde incl. sokkel: 1695 mm, IP44
	STC 2684	82.12.046.029	 6.418.074.032.980	1	Gadeskab uden sokkel STC 2684 Skab HXBXD: 840x265x250 mm. indvendig dybde 225 mm., IP44
	STCP 2684/25 MSR	82.12.048.548	 6.418.074.005.007	1	Målerstander med rude med montageplade. HXBXD: 840x265x250 mm. Højde incl. sokkel: 1695 mm, IP44
	STCP 2684/25 MSR-S	82.12.048.551	 6.418.074.005.014	1	Målerstander med rude og montageplade med monteret stikbensmåler klemrække 63 A. HXBXD: 840x265x250 mm. Højde incl. sokkel: 1695 mm, IP44
	STCP 2684/25 MSR-L	82.12.048.593	 6.418.074.068.415	1	Målerstander med rude og montageplade med monteret lednings måler 63 A. HXBXD: 840x265x250 mm. Højde incl. sokkel: 1695 mm, IP44

ST - 2684 tilbehør

	Typenr.	El-nr.	EAN-kode	Pakn. str.	Beskrivelse
	MPF 2684	82.12.047.206	 6.418.074.041.807	1	Montageplade MPF 2684 10 mm. opsukket Forex plade Størrelse 230 x 780 mm.
	MPI 2684	82.12.046.676	 6.418.074.038.555	1	Montageplade MPI 2684 4 mm. pvc plade størrelse 230 x 780 mm.
	MPS 2684	82.12.047.138	 6.418.074.041.623	1	Montageplade MPS 2684 2 mm. elforsinket stål plade Størrelse 230x780 mm.
	SMP 42/84	82.12.046.566	 6.418.074.036.711	1	Sideprofil for montageplade for højde 42/84
	STP 2642	82.12.046.362	 6.418.074.035.707	1	Gadeskabs sokkel STP 2642 HxBxD 855x265x250 mm. IK10
	CHP 26	82.12.046.456	 6.418.074.041.388	1	Metal Profil for kabel holder CHP 26
	CBB 26	82.12.047.329	 6.418.074.041.562	1	kopper skinne STCP/STC str 26 Maks 400 A Størrelse 40x5, længde 172 mm.





ST - 4042

	Typenr.	El-nr.	EAN-kode	Pakn. str.	Beskrivelse
	STCP 4042	82.12.046.207	 6.418.074.034.861	1	Gadeskab med sokkel STCP 4042 Skab HxBxD: 420x400x250 mm. Højde incl. sokkel: 1275 mm, IP44
	STC 4042	82.12.046.032	 6.418.074.032.997	1	Gadeskab uden sokkel STC 4042 Skab HxBxD: 420x400x250 mm. indvendig dybde 225 mm., IP44

ST - 4042 tilbehør

	Typenr.	El-nr.	EAN-kode	Pakn. str.	Beskrivelse
	MPF 4042	82.12.046.964	 6.418.074.041.814	1	Montageplade MPF 4042 10 mm. opskummet Forex plade Størrelse 370x360 mm.
	MPI 4042	82.12.046.689	 6.418.074.038.562	1	Montageplade MPI 4042 4 mm. pvc plade størrelse 370x360 mm.
	MPS 4042	82.12.046.838	 6.418.074.041.630	1	Montageplade MPS 4042 2 mm. elforsinket stål plade Størrelse 370x360 mm.
	SMP 42/84	82.12.046.566	 6.418.074.036.711	1	Sideprofil for montageplade for højde 42/84
	CHP 40	82.12.046.469	 6.418.074.035.981	1	Profil for kabel holder CHP 40 bortset fra 4088
	STP 4042	82.12.046.375	 6.418.074.035.714	1	Gadeskabs sokkel STP 4042 HxBxD 855 x 400x250 mm. IK10
	CBB 42	82.12.047.332	 6.418.074.041.579	1	kobber skinne STCP/STC str 42 Maks 400 A Størrelse 40x5, længde 307 mm.

ST - 4058

	Typenr.	El-nr.	EAN-kode	Pakn. str.	Beskrivelse
	STCP 4058	82.12.046.210	 6.418.074.034.878	1	Gadeskab med sokkel STCP 4058 skab HxBxD: 580x400x250 mm. højde incl. Sokkel: 1435 mm., IP44
	STC 4058	82.12.046.045	 6.418.074.033.178	1	Gadeskab uden sokkel STC 4058 Skab HxBxD: 580x400x250 mm. indvendig dybde 225 mm., IP44

ST - 4058 tilbehør

	Typenr.	El-nr.	EAN-kode	Pakn. str.	Beskrivelse
	MPF 4058	82.12.046.980	 6.418.074.041.821	1	Montageplade MPF 4058 10 mm. opskummet Forex plade Størrelse 370 x520 mm.
	MPI 4058	82.12.046.692	 6.418.074.038.579	1	Montageplade MPI 4058 4 mm. pvc plade størrelse 370x520 mm.
	MPS 4058	82.12.046.854	 6.418.074.041.647	1	Montageplade MPS 4058 2 mm. elforsinket stål plade Størrelse 370x520 mm.
	SMP 58	82.12.046.595	 6.418.074.037.992	1	Sideprofil for montageplade for højde 58
	CHP 40	82.12.046.469	 6.418.074.035.981	1	Profil for kabel holder CHP 40 bortset fra 4088
	STP 4042	82.12.046.375	 6.418.074.035.714	1	Gadeskabs sokkel STP 4042 HxBxD 855x400x250 mm. IK10
	CBB 42	82.12.047.332	 6.418.074.041.579	1	kobber skinne STCP/STC str 42 Maks 400 A Størrelse 40x5, længde 307 mm.





ST - 4084

	Typenr.	El-nr.	EAN-kode	Pakn. str.	Beskrivelse
	STCP 4084	82.12.046.223	 6.418.074.034.885	1	Gadeskab med sokkel STCP 4084 Skab HXBXD: 840x400x250 mm. Højde incl. sokkel: 1695 mm, IP44
	STC 4084	82.12.046.058	 6.418.074.033.291	1	Gadeskab uden sokkel STC 4084 Skab HXBXD: 840x400x250 mm. indvendig dybde 225 mm., IP44
	STCP 4084/25- MSR	82.12.048.564	 6.418.074.009.203	1	Målerstander med rude med montage- plade. HXBXD: 840x400x250 mm. Højde incl. sokkel: 1695 mm, IP44
	STCP 4084/25- MSR-L	82.12.048.577	 6.418.074.009.821	1	Målerstander med rude og montageplade med monteret lednings måler klemrække 63 A. HXBXD: 840x400x250 mm. Højde incl. sokkel: 1695 mm, IP44
	STCP 4084/25- MSR-S	82.12.048.580	 6.418.074.009.937	1	Målerstander med rude og montageplade med monteret stikbensmålerramme 63 A. HXBXD: 840x400x250 mm. Højde incl. sokkel: 1695 mm, IP44

ST - 4084 tilbehør





	Typenr.	El-nr.	EAN-kode	Pakn. str.	Beskrivelse
	MPF 4084	82.12.047.219	 6.418.074.041.838	1	Montageplade MPF 4084 10 mm.opskummet Forex plade Størrelse 370x780 mm.
	MPI 4084	82.12.046.702	 6.418.074.038.586	1	Montageplade MPI 4084 4 mm.pvc plade. størrelse 370x780 mm.
	MPS 4084	82.12.047.141	 6.418.074.041.654	1	Montageplade MPS 4084 2 mm elforsinket stål plade Størrelse 370x780 mm.
	CHP 40	82.12.046.469	 6.418.074.035.981	1	Profil for kabel holder CHP 40 bortset fra 4088
	SMP 42/84	82.12.046.566	 6.418.074.036.711	1	Sideprofil for montageplade for højde 42/84
	STP 4042	82.12.046.375	 6.418.074.035.714	1	Gadeskabs sokkel STP 4042 HxBxD 855 x 400x250 mm. IK10
	CBB 42	82.12.047.332	 6.418.074.041.579	1	kobber skinne STCP/STC str 42 Maks 400 A Størrelse 40x5, længde 307 mm.

ST - 4088/32

	Typenr.	El-nr.	EAN-kode	Pakn. str.	Beskrivelse
	STCP 4088/32	82.12.046.236	 6.418.074.034.892	1	Gadeskab med sokkel STCP 4088/32 Skab HxBxD: 880x400x320 mm. Højde incl. sokkel: 1735 mm., IP44
	STC 4088/32	82.12.046.799	 6.418.074.033.345	1	Gadeskab uden sokkel STC 4088/32 Skab HxBxD: 880x400x320 mm. indvendig dybde 295 mm., IP44





ST - 4088/32 tilbehør

	Typenr.	El-nr.	EAN-kode	Pakn. str.	Beskrivelse
	MPF 4088	82.12.047.222	 6.418.074.041.845	1	Montageplade MPF 4088 10 mm. opskummet Forex plade Størrelse 350x840 mm.
	MPI 4088	82.12.046.715	 6.418.074.038.593	1	Montageplade MPI 4088 4 mm. pvc plade. Størrelse 350x840 mm.
	MPS 4088	82.12.047.154	 6.418.074.041.661	1	Montageplade MPS 4088 2 mm. elforsinket stål plade Størrelse 350x840 mm.
	CHP 4088	82.12.046.472	 6.418.074.035.998	1	Metal Profil for kabel holder CHP 4088
	SMP 44/88	82.12.046.579	 6.418.074.037.978	1	Sideprofil for montageplade for højde 44/88
	STP 4088/32	82.12.046.388	 6.418.074.035.721	1	Gadeskabs sokkel STP 4088/32 HxBxD 850 x 400x320 mm. IK10
	CBB 4088	82.12.047.280	 6.418.074.041.524	1	køber skinne for STCP/STC4088 Maks 400 A Størrelse 40x5, længde 355 mm.

	Typenr.	El-nr.	EAN-kode	Pakn. str.	Beskrivelse
	STCP 5342	82.12.046.249	 6.418.074.035.332	1	Gadeskab med sokkel STCP 5342 Skab HxBxD: 420x530x250 mm. Højde incl. sokkel: 1275 mm., IP44
	STC 5342	82.12.046.809	 6.418.074.033.413	1	Gadeskab uden sokkel STC 5342 Skab HxBxD: 420x530x250 mm. indvendig dybde 225 mm., IP44

ST - 5342 tilbehør





	Typenr.	El-nr.	EAN-kode	Pakn. str.	Beskrivelse
	MPF 5342	82.12.046.993	 6.418.074.041.852	1	Montageplade MPF 5342 10 mm. opskummet Forex plade Størrelse 500x360 mm.
	MPI 5342	82.12.046.728	 6.418.074.038.609	1	Montageplade MPI 5342 4 mm. pvc plade. Størrelse 500x360 mm.
	MPS 5342	82.12.046.867	 6.418.074.041.678	1	Montageplade MPS 5342 2 mm. elforsinket stål plade Størrelse 500x360 mm.
	SMP 42/84	82.12.046.566	 6.418.074.036.711	1	Sideprofil for montageplade for højde 42/84
	CHP 53	82.12.046.485	 6.418.074.036.155	1	Profil for kabel holder CHP 53 bortset fra 5388
	STP 5342	82.12.046.391	 6.418.074.035.738	1	Gadeskabs sokkel STP 5342 HxBxD 855 x 530x250 mm. IK10
	CBB 53	82.12.047.345	 6.418.074.041.586	1	kobber skinne STCP/STC str 53 Maks 400 A Størrelse 40x5, længde 437 mm.

	Typenr.	El-nr.	EAN-kode	Pakn. str.	Beskrivelse
	STCP 5358	82.12.046.252	 6.418.074.035.349	1	Gadeskab med sokkel STCP 5358 Skab HxBxD: 580x530x250 mm. Højde incl. sokkel: 1435 mm., IP44
	STC 5358	82.12.046.061	 6.418.074.033.420	1	Gadeskab uden sokkel STC 5358 Skab HxBxD: 580x530x250 mm. indvendig dybde 225 mm., IP44

ST - 5358 tilbehør

	Typenr.	El-nr.	EAN-kode	Pakn. str.	Beskrivelse
	MPF 5358	82.12.047.015	 6.418.074.041.869	1	Montageplade MPF 5358 10 mm. opskummet Forex plade Størrelse 500 x 520 mm.
	MPI 5358	82.12.046.731	 6.418.074.038.616	1	Montageplade MPI 5358 4 mm. pvc plade. størrelse 500x520 mm.
	MPS 5358	82.12.046.883	 6.418.074.041.685	1	Montageplade MPS 5358 2 mm elforsinket stål plade Størrelse 500x520 mm.
	SMP 58	82.12.046.595	 6.418.074.037.992	1	Sideprofil for montageplade for højde 58
	CHP 53	82.12.046.485	 6.418.074.036.155	1	Profil for kabel holder CHP 53 bortset fra 5388
	STP 5342	82.12.046.391	 6.418.074.035.738	1	Gadeskabs sokkel STP 5342 HxBxD 855 x 530 x 250 mm. IK10
	CBB 53	82.12.047.345	 6.418.074.041.586	1	kobber skinne STCP/STC str 53 Maks 400 A Størrelse 40x5, længde 437 mm.





ST - 5384

	Typenr.	El-nr.	EAN-kode	Pakn. str.	Beskrivelse
	STCP 5384	82.12.046.265	 6.418.074.035.356	1	Gadeskab med sokkel STCP 5384 Skab HxBxD: 840x530x250 mm. Højde incl. sokkel: 1695 mm., IP44
	STC 5384	82.12.046.074	 6.418.074.033.437	1	Gadeskab uden sokkel STC 5384 Skab HxBxD: 840x530x250 mm. indvendig dybde 225 mm., IP44

ST - 5384 tilbehør

	Typenr.	El-nr.	EAN-kode	Pakn. str.	Beskrivelse
	MPF 5384	82.12.047.235	 6.418.074.041.876	1	Montageplade MPF 5384 10 mm. opskummet Forex plade Størrelse 500x780 mm.
	MPI 5384	82.12.046.744	 6.418.074.038.623	1	Montageplade MPI 5384 4 mm. pvc plade. Størrelse 500x780 mm.
	MPS 5384	82.12.047.167	 6.418.074.041.692	1	Montageplade MPS 5384 2 mm. elforsinket stål plade Størrelse 500x780 mm.
	CHP 53	82.12.046.485	 6.418.074.036.155	1	Profil for kabel holder CHP 53 bortset fra 5388
	SMP 42/84	82.12.046.566	 6.418.074.036.711	1	Sideprofil for montageplade for højde 42/84
	STP 5342	82.12.046.391	 6.418.074.035.738	1	Gadeskabs sokkel STP 5342 HxBxD 855x530x250 mm. IK10
	CBB 42	82.12.047.332	 6.418.074.041.579	1	kobber skinne STCP/STC str 42 Maks 400 A Størrelse 40x5, længde 307 mm.





ST - 5388/32

	Typenr.	El-nr.	EAN-kode	Pakn. str.	Beskrivelse
	STCP 5388/32	82.12.046.278	 6.418.074.035.363	1	Gadeskab med sokkel STCP 5388/32 Skab HxBxD: 880x530x320 mm. Højde incl. sokkel: 1735 mm., IP44
	STC 5388/32	82.12.046.087	 6.418.074.034.106	1	Gadeskab uden sokkel STC 5388/32 Skab HxBxD: 880x530x320 mm. indvendig dybde 295 mm., IP44

ST - 5388/32 tilbehør





	Typenr.	El-nr.	EAN-kode	Pakn. str.	Beskrivelse
	MPF 5388	82.12.047.248	 6.418.074.041.883	1	Montageplade MPF 5388 10 mm. opskummet Forex plade Størrelse 490x840 mm.
	MPI 5388	82.12.046.757	 6.418.074.038.630	1	Montageplade MPI 5388 4 mm. pvc plade Størrelse 490x840 mm.
	MPS 5388	82.12.047.170	 6.418.074.041.708	1	Montageplade MPS 5388 2 mm. elforsinket stål plade Størrelse 490x840 mm.
	CHP 5388	82.12.046.498	 6.418.074.036.261	1	Metalprofil for kabelholder CHP 5388
	SMP 44/88	82.12.046.579	 6.418.074.037.978	1	Sideprofil for montageplade for højde 44/88
	STP 5388/32	82.12.046.401	 6.418.074.035.745	1	Gadeskabs sokkel STP 5388/32 HxBxD 855x530x250 mm. IK10
	CBB 5388	82.12.047.293	 6.418.074.041.531	1	Kobberskinne for STCP/STC 5388 Maks 400 A Størrelse 40x5, længde 485 mm.

ST - 6644

	Typenr.	El-nr.	EAN-kode	Pakn. str.	Beskrivelse
	STCP 6644	82.12.046.281	 6.418.074.035.370	1	Gadeskab med sokkel STCP 6644 Skab HXBXD: 440x660x250 mm. Højde incl. sokkel: 1290 mm., IP44
	STC 6644	82.12.046.090	 6.418.074.034.113	1	Gadeskab uden sokkel STC 6644 Skab HXBXD: 440x660x250 mm. Indvendig dybde 225 mm., IP44





ST - 6644 tilbehør

	Typenr.	El-nr.	EAN-kode	Pakn. str.	Beskrivelse
	MPF 6644	82.12.047.028	 6.418.074.041.890	1	Montageplade MPF 6644 10 mm. opskummet Forex plade Størrelse 610x420 mm.
	MPI 6644	82.12.046.760	 6.418.074.038.647	1	Montageplade MPI 6644 4 mm pvc plade Størrelse 610x420 mm.
	MPS 6644	82.12.046.896	 6.418.074.041.715	1	Montageplade MPS 6644 2 mm. elforsinket stålplade. Størrelse 610x420 mm.
	SMP 44/88	82.12.046.579	 6.418.074.037.978	1	Sideprofil for montageplade for højde 44/88
	CHP 66	82.12.046.508	 6.418.074.036.278	1	Metalprofil for kabelholder CHP 66
	STP 6644	82.12.046.414	 6.418.074.035.752	1	Gadeskabssokkel STP 6644 HxBxD 850x660x250 mm. IK10
	CBB 66	82.12.047.303	 6.418.074.041.548	1	Kobberskinne STCP/STC str 66. Maks 400 A. Størrelse 40x5, længde 620 mm.

	Typenr.	El-nr.	EAN-kode	Pakn. str.	Beskrivelse
	STCP 6657	82.12.046.294	 6.418.074.035.387	1	Gadeskab med sokkel STCP 6657 Skab HxBxD: 570x660x250 mm. Højde incl. sokkel: 1420 mm., IP44
	STC 6657	82.12.046.100	 6.418.074.034.632	1	Gadeskab uden sokkel STC 6657 Skab HxBxD: 570x660x250 mm. Indvendig dybde 225 mm., IP44

ST - 6657 tilbehør





	Typenr.	El-nr.	EAN-kode	Pakn. str.	Beskrivelse
	MPF 6657	82.12.047.031	 6.418.074.041.906	1	Montageplade MPF 6657 10 mm. opskummet Forex plade Størrelse 610x540 mm.
	MPI 6657	82.12.046.773	 6.418.074.038.654	1	Montageplade MPI 6657 4 mm pvc plade Størrelse 610x540 mm.
	MPS 6657	82.12.046.906	 6.418.074.041.722	1	Montageplade MPS 6657 2mm. elforsinket stålplade Størrelse 610x540 mm.
	SMP 57	82.12.046.582	 6.418.074.037.985	1	Sideprofil for montageplade for højde 57
	CHP 66	82.12.046.508	 6.418.074.036.278	1	Metalprofil for kabelholder CHP 66
	STP 6644	82.12.046.414	 6.418.074.035.752	1	Gadeskabssokkel STP 6644 HxBxD 850 x 660x250 mm. IK10
	CBB 66	82.12.047.303	 6.418.074.041.548	1	Kobberskinne STCP/STC str 66. Maks 400 A. Størrelse 40x5, længde 620 mm.

	Typenr.	El-nr.	EAN-kode	Pakn. str.	Beskrivelse
	STCP 6688	82.12.046.304	 6.418.074.035.394	1	Gadeskab med sokkel STCP 6688 Skab HxBxD: 880x660x250 mm. Højde incl. sokkel: 1730 mm., IP44
	STC 6688	82.12.046.113	 6.418.074.034.731	1	Gadeskab uden sokkel STC 6688 Skab HxBxD: 880x660x250 mm. Indvendig dybde 225 mm., IP44

ST - 6688 tilbehør

	Typenr.	El-nr.	EAN-kode	Pakn. str.	Beskrivelse
	MPF 6688	82.12.047.251	 6.418.074.041.913	1	Montageplade MPF 6688 10 mm. opskummet Forex plade Størrelse 610x840 mm.
	MPI 6688	82.12.046.786	 6.418.074.038.661	1	Montageplade MPI 6688 4 mm. pvc plade Størrelse 610x840 mm.
	MPS 6688	82.12.047.183	 6.418.074.041.739	1	Montageplade MPS 6688 2 mm. elforsinket stålplade Størrelse 610x840 mm.
	CHP 66	82.12.046.508	 6.418.074.036.278	1	Metalprofil for kabelholder CHP 66
	SMP 44/88	82.12.046.579	 6.418.074.037.978	1	Sideprofil for montageplade for højde 44/88
	STP 6644	82.12.046.414	 6.418.074.035.752	1	Gadeskabssokkel STP 6644 HxBxD 850x660x250 mm. IK10
	CBB 66	82.12.047.303	 6.418.074.041.548	1	Kobberskinne STCP/STC str 66. Maks 400 A. Størrelse 40x5, længde 620 mm.





ST - 6688/32

	Typenr.	El-nr.	EAN-kode	Pakn. str.	Beskrivelse
	STCP 6688/32	82.12.046.317	 6.418.074.035.400	1	Gadeskab med sokkel STCP 6688/32 Skab HXBxD: 880x660x320 mm. Højde incl. sokkel: 1730 mm., IP44
	STC 6688/32	82.12.046.126	 6.418.074.034.748	1	Gadeskab uden sokkel STC 6688/32 Skab HXBxD: 880x660x320 mm. Indvendig dybde 295 mm., IP44

ST - 6688/32 tilbehør

	Typenr.	El-nr.	EAN-kode	Pakn. str.	Beskrivelse
	MPF 6688	82.12.047.251	 6.418.074.041.913	1	Montageplade MPF 6688 10 mm. opskummet Forex plade Størrelse 610x840 mm.
	MPI 6688	82.12.046.786	 6.418.074.038.661	1	Montageplade MPI 6688 4 mm. pvc plade Størrelse 610x840 mm.
	MPS 6688	82.12.047.183	 6.418.074.041.739	1	Montageplade MPS 6688 2 mm. elforsinket stålplade Størrelse 610x840 mm.
	CHP 66	82.12.046.508	 6.418.074.036.278	1	Metalprofil for kabelholder CHP 66
	SMP 44/88	82.12.046.579	 6.418.074.037.978	1	Sideprofil for montageplade for højde 44/88
	STP 6688/32	82.12.046.427	 6.418.074.035.790	1	Gadeskabssokkel STP 6688/32 HxBxD 850x660x320 mm. IK10
	CBB 66	82.12.047.303	 6.418.074.041.548	1	Kobberskinne STCP/STC str 66. Maks 400 A. Størrelse 40x5, længde 620 mm.





ST - 8042

	Typenr.	El-nr.	EAN-kode	Pakn. str.	Beskrivelse
	STCP 8042	82.12.046.320	 6.418.074.035.660	1	Gadeskab med sokkel STCP 8042 Skab HxBxD: 420x800x250 mm. Højde incl. sokkel: 1275 mm., IP44
	STC 8042	82.12.046.139	 6.418.074.034.755	1	Gadeskab uden sokkel STC 8042 Skab HxBxD: 420x800x250 mm. Indvendig dybde 225 mm., IP44

ST - 8042 tilbehør

	Typenr.	El-nr.	EAN-kode	Pakn. str.	Beskrivelse
	MPF 8042	82.12.047.044	 6.418.074.041.920	1	Montageplade MPF 8042 10 mm. opskummet Forex plade Størrelse 770x360 mm.
	MPI 8042	82.12.047.361	 6.418.074.041.456	1	Montageplade MPI 8042 4 mm. pvc plade Størrelse 770x360 mm.
	MPS 8042	82.12.046.919	 6.418.074.041.746	1	Montageplade MPS 8042 2 mm. elforsinket stålplade Størrelse 770x360 mm.
	SMP 42/84	82.12.046.566	 6.418.074.036.711	1	Sideprofil for montageplade for højde 42/84
	CHP 80	82.12.046.511	 6.418.074.036.438	1	Metalprofil for kabelholder CHP 80 bortset fra 8088
	STP 8042	82.12.046.430	 6.418.074.035.813	1	Gadeskabssokkel STP 8042 HxBxD 855x800x250 mm. IK10
	CBB 80	82.12.047.358	 6.418.074.041.593	1	Kobberskinne STCP/STC str 80 Maks 400 A Størrelse 40x5, længde 707 mm.





ST - 8058

	Typenr.	El-nr.	EAN-kode	Pakn. str.	Beskrivelse
	STCP 8058	82.12.046.333	 6.418.074.035.677	1	Gadeskab med sokkel STCP 8058 Skab HXBxD: 580x800x250 mm. Højde incl. sokkel: 1435 mm., IP44
	STC 8058	82.12.046.142	 6.418.074.034.762	1	Gadeskab uden sokkel STC 8058 Skab HXBxD: 580x800x250 mm. Indvendig dybde 225 mm., IP44

ST - 8058 tilbehør

	Typenr.	El-nr.	EAN-kode	Pakn. str.	Beskrivelse
	MPF 8058	82.12.047.057	 6.418.074.041.937	1	Montageplade MPF 8058 10 mm. opskummet Forex plade Størrelse 770x520 mm.
	MPI 8058	82.12.047.374	 6.418.074.041.463	1	Montageplade MPI 8058 4 mm. pvc plade Størrelse 770x520 mm.
	MPS 8058	82.12.046.922	 6.418.074.041.753	1	Montageplade MPS 8058 2 mm. elforsinket stålplade Størrelse 770x520 mm.
	SMP 58	82.12.046.595	 6.418.074.037.992	1	Sideprofil for montageplade for højde 58
	CHP 80	82.12.046.511	 6.418.074.036.438	1	Metalprofil for kabelholder CHP 80 bortset fra 8088
	STP 8042	82.12.046.430	 6.418.074.035.813	1	Gadeskabssokkel STP 8042 HxBxD 855x800x250 mm. IK10
	CBB 80	82.12.047.358	 6.418.074.041.593	1	Kobberskinne STCP/STC str 80 Maks 400 A Størrelse 40x5, længde 707 mm.





ST - 8084

	Typenr.	El-nr.	EAN-kode	Pakn. str.	Beskrivelse
	STCP 8084	82.12.046.346	 6.418.074.035.684	1	Gadeskab med sokkel STCP 8084 Skab HxBxD: 840x800x250 mm. Højde incl. sokkel: 1695 mm., IP44
	STC 8084	82.12.046.155	 6.418.074.034.779	1	Gadeskab uden sokkel STC 8084 Skab HxBxD: 840x800x250 mm. Indvendig dybde 225 mm., IP44

ST - 8084 tilbehør

	Typenr.	El-nr.	EAN-kode	Pakn. str.	Beskrivelse
	MPF 8084	82.12.047.264	 6.418.074.041.944	1	Montageplade MPF 8084 10 mm. opskummet Forex plade Størrelse 770x780 mm.
	MPI 8084	82.12.047.387	 6.418.074.041.470	1	Montageplade MPI 8084 4 mm. pvc plade Størrelse 770x780 mm.
	MPS 8084	82.12.047.196	 6.418.074.041.760	1	Montageplade MPS 8084 2 mm. elforsinket stålplade Størrelse 770x780 mm.
	CHP 80	82.12.046.511	 6.418.074.036.438	1	Metalprofil for kabelholder CHP 80 bortset fra 8088
	SMP 42/84	82.12.046.566	 6.418.074.036.711	1	Sideprofil for montageplade for højde 42/84
	STP 8042	82.12.046.430	 6.418.074.035.813	1	Gadeskabssokkel STP 8042 HxBxD 855x800x250 mm. IK10
	CBB 80	82.12.047.358	 6.418.074.041.593	1	Kobberskinne STCP/STC str 80 Maks 400 A Størrelse 40x5, længde 707 mm.

ST - 8088/32

	Typenr.	El-nr.	EAN-kode	Pakn. str.	Beskrivelse
	STCP 8088/32	82.12.046.359	 6.418.074.035.691	1	Gadeskab med sokkel STCP 8088/32 Skab HxBxD: 880x800x320 mm. Højde incl. sokkel: 1735 mm., IP44
	STC 8088/32	82.12.046.168	 6.418.074.034.786	1	Gadeskab uden sokkel STC 8088/32 Skab HxBxD: 880x800x320 mm. Indvendig dybde 295 mm., IP44

ST - 8088/32 tilbehør

	Typenr.	El-nr.	EAN-kode	Pakn. str.	Beskrivelse
	MPF 8088	82.12.047.060	 6.418.074.041.951	1	Montageplade MPF 8088 10 mm. opskummet Forex plade Størrelse 750x840 mm.
	MPI 8088	82.12.047.390	 6.418.074.041.487	1	Montageplade MPI 8088 4 mm. pvc plade Størrelse 750x840 mm.
	MPS 8088	82.12.046.935	 6.418.074.041.777	1	Montageplade MPS 8088 2 mm. elforsinket stålplade Størrelse 750x840 mm.
	CHP 8088	82.12.046.524	 6.418.074.036.445	1	Profil for kabel holder CHP 8088
	SMP 44/88	82.12.046.579	 6.418.074.037.978	1	Sideprofil for montageplade for højde 44/88
	STP 8088/32	82.12.046.443	 6.418.074.041.371	1	Gadeskabssokkel STP 8088/32 HxBxD 850 x 800 x 320 mm. IK10
	CBB 8088	82.12.047.316	 6.418.074.041.555	1	Kobberskinne for STCP/STC 8088 Maks 400 A Størrelse 40x5, længde 755 mm.

ST - 53+5388/32

	Typenr.	El-nr.	EAN-kode	Pakn. str.	Beskrivelse
	STCP 53+5388/32	82.12.047.073	 6.418.074.041.395	1	Gadeskab m. sokkel STCP 53+5388/32 Bestående af to STCP53 skabe IP44, IK10, 1730x1060x320 mm.



















ST - 53+5388/32 tilbehør

	Typenr.	El-nr.	EAN-kode	Pakn. str.	Beskrivelse
	MPF 5388	82.12.047.248	 6.418.074.041.883	1	Montageplade MPF 5388 10 mm. opskummet Forex plade Størrelse 490x840 mm.
	MPI 5388	82.12.046.757	 6.418.074.038.630	1	Montageplade MPI 5388 4 mm. pvc plade Størrelse 490x840 mm.
	MPS 5388	82.12.047.170	 6.418.074.041.708	1	Montageplade MPS 5388 2 mm. elforsinket stål plade Størrelse 490x840 mm.
	CHP 5388	82.12.046.498	 6.418.074.036.261	1	Metal Profil for kabelholder CHP 5388
	SMP 44/88	82.12.046.579	 6.418.074.037.978	1	Sideprofil for montageplade for højde 44/88
	CBB 53	82.12.047.345	 6.418.074.041.586	1	Kobberskinne STCP/STC str 53 Maks 400 A Størrelse 40x5, længde 437 mm.

ST - 66+4088/32

	Typenr.	El-nr.	EAN-kode	Pakn. str.	Beskrivelse
	STCP 66+4088/32	82.12.047.086	 6.418.074.041.401	1	Gadeskab m. sokkel STCP 66+4088/32 bestående af STCP 66 og 40 skab IP44, IK10, 1730x1060x320 mm.

ST - 66+4088/32 tilbehør

	Typenr.	El-nr.	EAN-kode	Pakn. str.	Beskrivelse
	MPF 4088	82.12.047.222	 6.418.074.041.845	1	Montageplade MPF 4088 10 mm. opskummet Forex plade Størrelse 350x840 mm.
	MPI 4088	82.12.046.715	 6.418.074.038.593	1	Montageplade MPI 4088 4 mm. pvc plade. Størrelse 350x840 mm.
	MPS 4088	82.12.047.154	 6.418.074.041.661	1	Montageplade MPS 4088 2 mm. elforsinket stål plade Størrelse 350x840 mm.
	MPF 6688	82.12.047.251	 6.418.074.041.913	1	Montageplade MPF 6688 10 mm. opskummet Forex plade Størrelse 610x840 mm.
	MPI 6688	82.12.046.786	 6.418.074.038.661	1	Montageplade MPI 6688 4 mm. pvc plade Størrelse 610x840 mm.
	MPS 6688	82.12.047.183	 6.418.074.041.739	1	Montageplade MPS 6688 2 mm. elforsinket stålplade Størrelse 610x840 mm.
	CHP 8088	82.12.046.524	 6.418.074.036.445	1	Profil for kabelholder CHP 8088
	CHP 66	82.12.046.508	 6.418.074.036.278	1	Metalprofil for kabelholder CHP 66
	SMP 44/88	82.12.046.579	 6.418.074.037.978	1	Sideprofil for montageplade for højde 44/88
	CBB 66	82.12.047.303	 6.418.074.041.548	1	Kobberskinne STCP/STC str 66. Maks 400 A. Størrelse 40x5, længde 620 mm.
	CBB 4088	82.12.047.280	 6.418.074.041.524	1	Kobberskinne for STCP/STC4088 Maks 400 A Størrelse 40x5, længde 355 mm.

	Typenr.	El-nr.	EAN-kode	Pakn. str.	Beskrivelse
	STCP 66+5388/32	82.12.047.109	 6.418.074.041.425	1	Gadeskab m. sokkel STCP 66+5388/32 Bestående af STCP 66 og 53 skab IP44, IK10, 1730x1200x320 mm.

ST - 66+5388/32 tilbehør

	Typenr.	El-nr.	EAN-kode	Pakn. str.	Beskrivelse
	MPF 5388	82.12.047.248	 6.418.074.041.883	1	Montageplade MPF 5388 10 mm. opskummet Forex plade Størrelse 490x840 mm.
	MPI 5388	82.12.046.757	 6.418.074.038.630	1	Montageplade MPI 5388 4 mm. pvc plade Størrelse 490x840 mm.
	MPS 5388	82.12.047.170	 6.418.074.041.708	1	Montageplade MPS 5388 2 mm. elforsinket stålplade Størrelse 490x840 mm.
	MPF 6688	82.12.047.251	 6.418.074.041.913	1	Montageplade MPF 6688 10 mm. opskummet Forex plade Størrelse 610x840 mm.
	MPI 6688	82.12.046.786	 6.418.074.038.661	1	Montageplade MPI 6688 4 mm. pvc plade Størrelse 610x840 mm.
	MPS 6688	82.12.047.183	 6.418.074.041.739	1	Montageplade MPS 6688 2 mm. elforsinket stålplade Størrelse 610x840 mm.
	CHP 5388	82.12.046.498	 6.418.074.036.261	1	Metalprofil for kabelholder CHP 5388
	CHP 66	82.12.046.508	 6.418.074.036.278	1	Metalprofil for kabelholder CHP 66
	SMP 44/88	82.12.046.579	 6.418.074.037.978	1	Sideprofil for montageplade for højde 44/88
	CBB 5388	82.12.047.293	 6.418.074.041.531	1	Kobberskinne for STCP/STC 5388 Maks 400 A Størrelse 40x5, længde 485 mm.
	CBB 66	82.12.047.303	 6.418.074.041.548	1	Kobberskinne STCP/STC str 66. Maks 400 A. Størrelse 40x5, længde 620 mm.

ST - 80+4088/32

	Typenr.	El-nr.	EAN-kode	Pakn. str.	Beskrivelse
	STCP 80+4088/32	82.12.047.099	 6.418.074.041.418	1	Gadeskab m. sokkel STCP 80+4088/32 Bestående af STCP 80 og 40 skab IP44, IK10, 1730 x 1190 x 320 mm.















ST - 80+4088/32 tilbehør

	Typenr.	El-nr.	EAN-kode	Pakn. str.	Beskrivelse
	MPF 4088	82.12.047.222	 6.418.074.041.845	1	Montageplade MPF 4088 10 mm. opskummet Forex plade Størrelse 350x840 mm.
	MPI 4088	82.12.046.715	 6.418.074.038.593	1	Montageplade MPI 4088 4 mm. pvc plade. Størrelse 350x840 mm.
	MPS 4088	82.12.047.154	 6.418.074.041.661	1	Montageplade MPS 4088 2 mm elforsinket stål plade Størrelse 350x840 mm.
	MPF 8088	82.12.047.060	 6.418.074.041.951	1	Montageplade MPF 8088 10 mm. opskummet Forex plade Størrelse 75x840 mm.
	MPI 8088	82.12.047.390	 6.418.074.041.487	1	Montageplade MPI 8088 4 mm. pvc plade Størrelse 750x840 mm.
	MPS 8088	82.12.046.935	 6.418.074.041.777	1	Montageplade MPS 8088 2 mm. elforsinket stålplade Størrelse 750x840 mm.
	CHP 4088	82.12.046.472	 6.418.074.035.998	1	Metalprofil for kabelholder CHP 4088
	CHP 8088	82.12.046.524	 6.418.074.036.445	1	Profil for kabelholder CHP 8088
	SMP 44/88	82.12.046.579	 6.418.074.037.978	1	Sideprofil for montageplade for højde 44/88
	CBB 4088	82.12.047.280	 6.418.074.041.524	1	Kobberskinne for STCP/STC4088 Maks 400 A Størrelse 40x5, længde 355 mm.
	CBB 8088	82.12.047.316	 6.418.074.041.555	1	Kobberskinne for STCP/STC 8088 Maks 400 A Størrelse 40x5, længde 755 mm.

ST - 80+5388/32

	Typenr.	El-nr.	EAN-kode	Pakn. str.	Beskrivelse
	STCP 80+5388/32	82.12.047.112	 6.418.074.041.432	1	Gadeskab m. sokkel STCP 80+5388/32 Bestående af STCP 80 og 53 skab IP44, IK10, 1730x1330x320 mm.

ST - 80+5388/32 tilbehør

	Typenr.	El-nr.	EAN-kode	Pakn. str.	Beskrivelse
	MPF 5388	82.12.047.248	 6.418.074.041.883	1	Montageplade MPF 5388 10 mm. opskummet Forex plade Størrelse 490x840 mm.
	MPI 5388	82.12.046.757	 6.418.074.038.630	1	Montageplade MPI 5388 4 mm. pvc plade Størrelse 490x840 mm.
	MPS 5388	82.12.047.170	 6.418.074.041.708	1	Montageplade MPS 5388 2 mm. elforsinket stålplade Størrelse 490x840 mm.
	MPF 8088	82.12.047.060	 6.418.074.041.951	1	Montageplade MPF 8088 10 mm. opskummet Forex plade Størrelse 750x840 mm.
	MPI 8088	82.12.047.390	 6.418.074.041.487	1	Montageplade MPI 8088 4 mm. pvc plade Størrelse 750x840 mm.
	MPS 8088	82.12.046.935	 6.418.074.041.777	1	Montageplade MPS 8088 2 mm. elforsinket stålplade Størrelse 750x840 mm.
	CHP 8088	82.12.046.524	 6.418.074.036.445	1	Profil for kabelholder CHP 8088
	CHP 5388	82.12.046.498	 6.418.074.036.261	1	Metalprofil for kabelholder CHP 5388
	SMP 44/88	82.12.046.579	 6.418.074.037.978	1	Sideprofil for montageplade for højde 44/88
	CBB 5388	82.12.047.293	 6.418.074.041.531	1	Kobberskinne for STCP/STC 5388 Maks 400 A Størrelse 40x5, længde 485 mm.
	CBB 8088	82.12.047.316	 6.418.074.041.555	1	Kobberskinne for STCP/STC 5388 Maks 400 A Størrelse 40x5, længde 485 mm.

ST - 80+8088/32

	Typenr.	El-nr.	EAN-kode	Pakn. str.	Beskrivelse
	STCP 80+8088/32	82.12.047.125	 6.418.074.041.449	1	Gadeskab m. sokkel STCP 80+8088/32 bestående af to STCP 80 skabe IP44,IK10, 1730x1600x320 mm.

ST - 80+8088/32 tilbehør

	Typenr.	El-nr.	EAN-kode	Pakn. str.	Beskrivelse
	MPF 8088	82.12.047.060	 6.418.074.041.951	1	Montageplade MPF 8088 10 mm. opskummet Forex plade Størrelse 750x840 mm.
	MPI 8088	82.12.047.390	 6.418.074.041.487	1	Montageplade MPI 8088 4 mm. pvc plade Størrelse 750x840 mm.
	MPS 8088	82.12.046.935	 6.418.074.041.777	1	Montageplade MPS 8088 2 mm. elforsinket stålplade Størrelse 750x840 mm.
	CHP 8088	82.12.046.524	 6.418.074.036.445	1	Profil for kabelholder CHP 8088
	SMP 44/88	82.12.046.579	 6.418.074.037.978	1	Sideprofil for montageplade for højde 44/88
	CBB 8088	82.12.047.316	 6.418.074.041.555	1	Kobberskinne for STCP/STC 8088 Maks 400 A Størrelse 40x5, længde 755 mm.

Gadeskabe fælles tilbehør

	Typenr.	El-nr.	EAN-kode	Pakn. str.	Beskrivelse
	CH 5X120	82.12.046.540	 6.418.074.036.469	1	Kabelafastningsbøjle/-holder for max 5X120 mm ² kabel
	CH 5X240	82.12.046.553	 6.418.074.036.476	1	Kabel afastningsbøjle/-holder for max 5X240 mm ² kabel
	CH 5X35	82.12.046.537	 6.418.074.036.452	1	Kabel afastningsbøjle/-holder for max 5X35 mm ² kabel
	ID 16X9	82.12.046.634	 6.418.074.038.517	1	Inspektionsdør for evt. fjernbetjening Størrelse 160x90 mm.
	ID 27X15	82.12.046.621	 6.418.074.038.500	1	Inspektionsdør evt. fjernbetjening Størrelse 270x150 mm.
	LC-DB	82.12.046.618	 6.418.074.038.494	1	Dobbelt bar lås LC-DB
	LC-T6	82.12.046.605	 6.418.074.038.487	1	Trekantlåseindsats 6 mm. type LC-T6
	TI	82.12.046.647	 6.418.074.038.524	1	Gevindindsats
	PMS	82.12.047.413	 6.418.074.041.500	1	Rørmontagesæt PMS
	SHWP	82.12.047.277	 6.418.074.041.517	1	Svingbar lågehåndtag med mulighed for montage af hængelås
	VCC 240	82.12.047.400	 6.418.074.041.494	1	V-clamps VCC240 for kabler max 240 mm ²

STC 2642, 2658, 2684

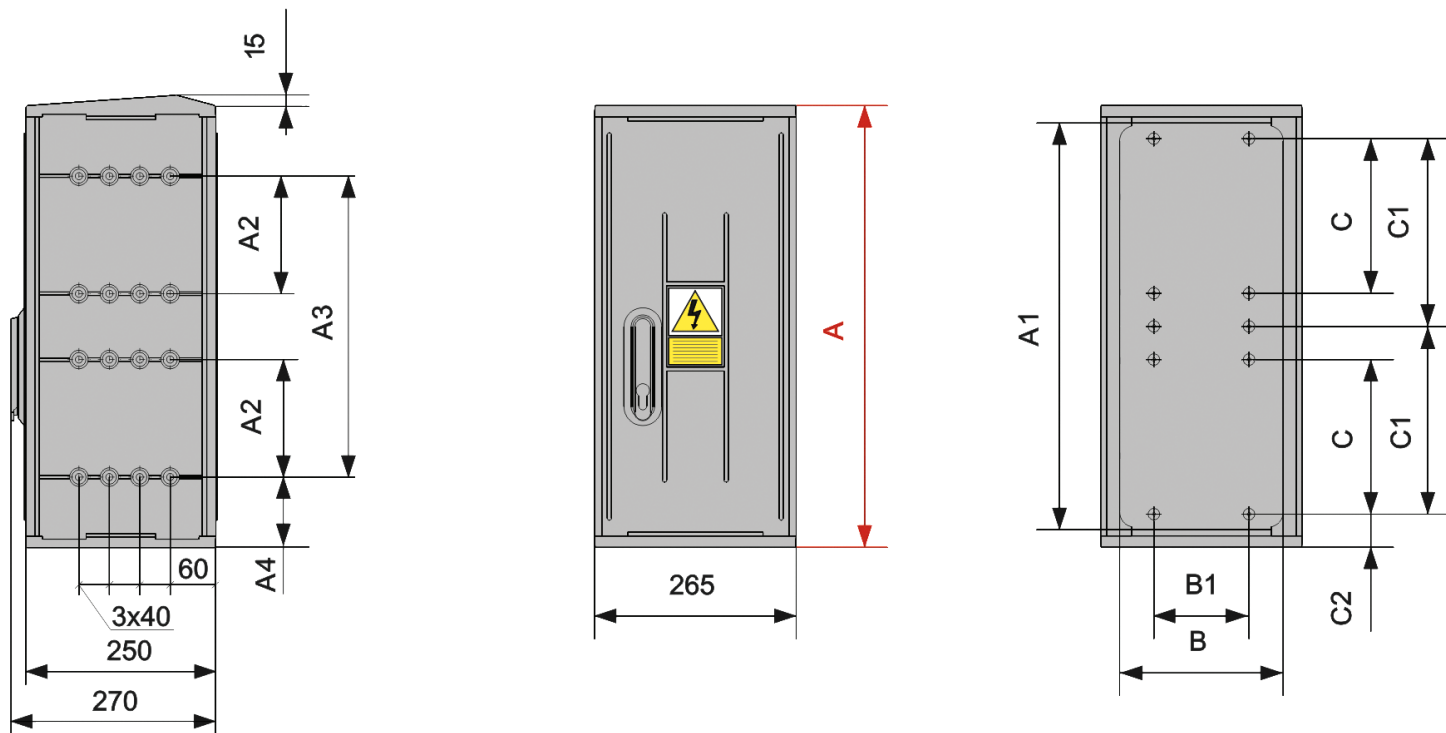

Type	A	A1	A2	A3	A4	B	B1	B2	C	C1	C2
STC 2642	420	374	-	235	92	215	125	-	-	166	43
STC 2658	580	534	-	395	92	215	125	-	-	246	43
STC 2684	840	794	235	-	92	215	125	-	333	-	43

Sokler løse 250 mm

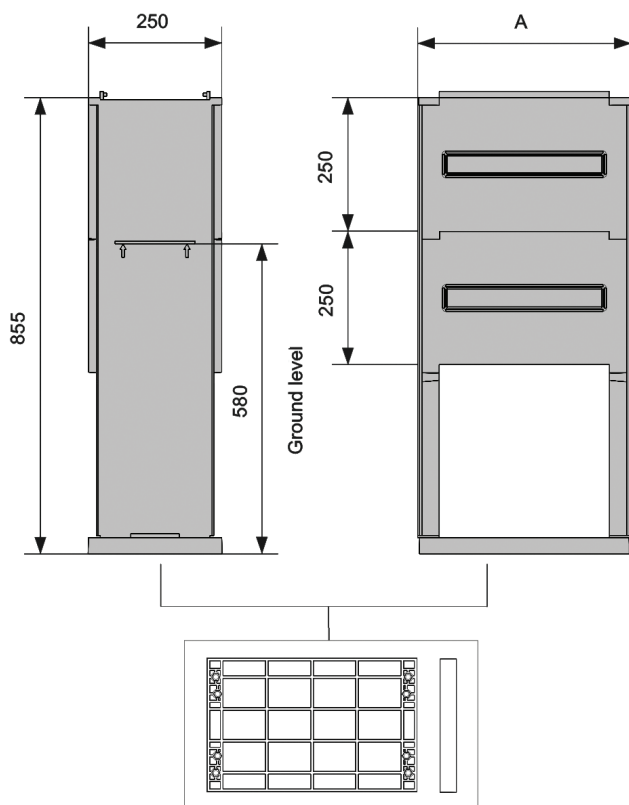

Type	A
STP 2642	265
STP 4042	400
STP 5342	530
STP 8084	800

STC 4042, 4058, 4084

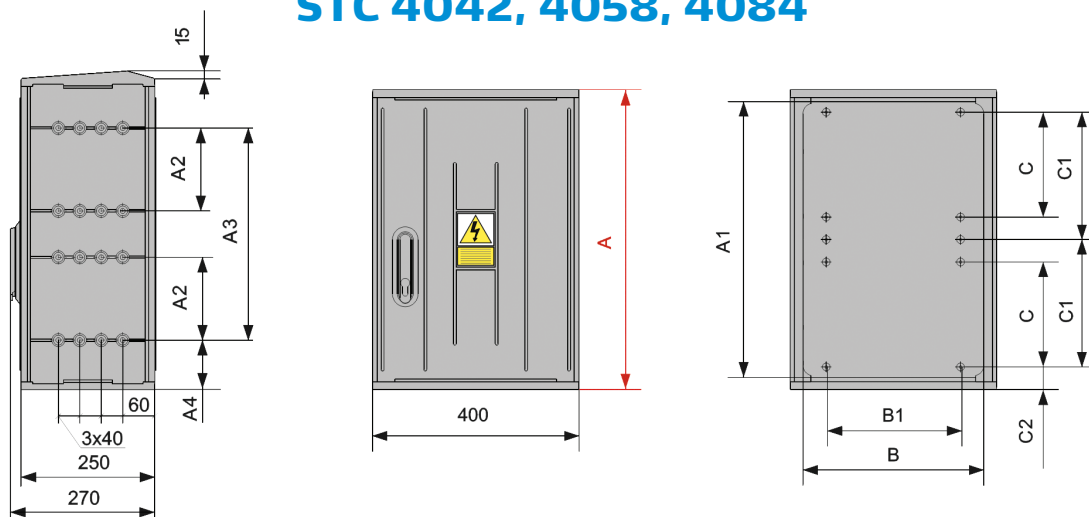

Type	A	A1	A2	A3	A4	B	B1	B2	C	C1	C2
STC 4042	420	374	-	235	92	350	260	-	-	166	43
STC 4058	580	534	-	395	92	350	260	-	-	246	43
STC 4084	840	794	235	-	92	350	260	-	333	-	43

STC4088/32

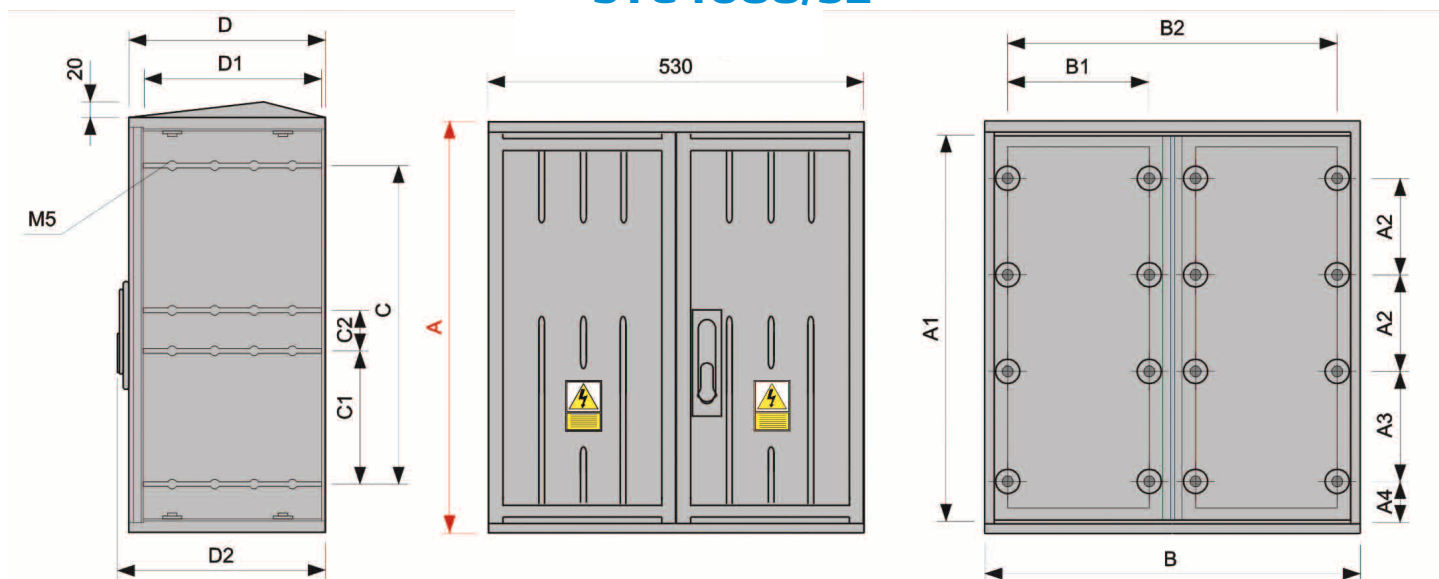

Type	A	A1	A2	A3	A4	B	B1	C	C1	C2	D	D1	D2
STC 4088/ 32	880	840	185	240	75	360	325	675	235	205	320	295	340

Sokler løse /32

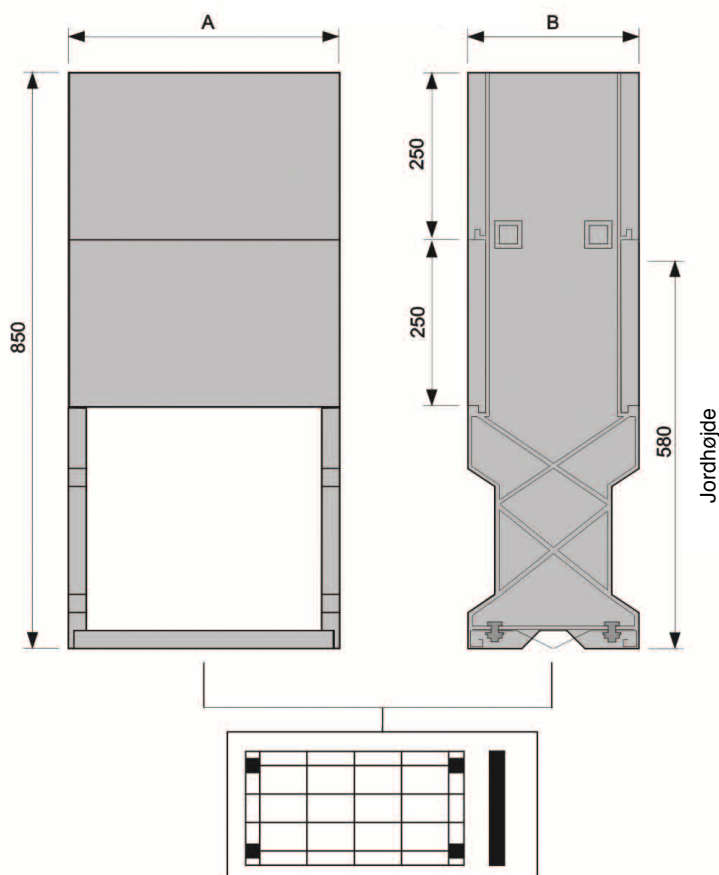

Type	A	B
STP 4088/32	400	-
STP 5388/32	530	-
STP 6644	660	250
STP 6088/32	660	-
STP 8088/32	800	-

STC 5342, 5358, 5384

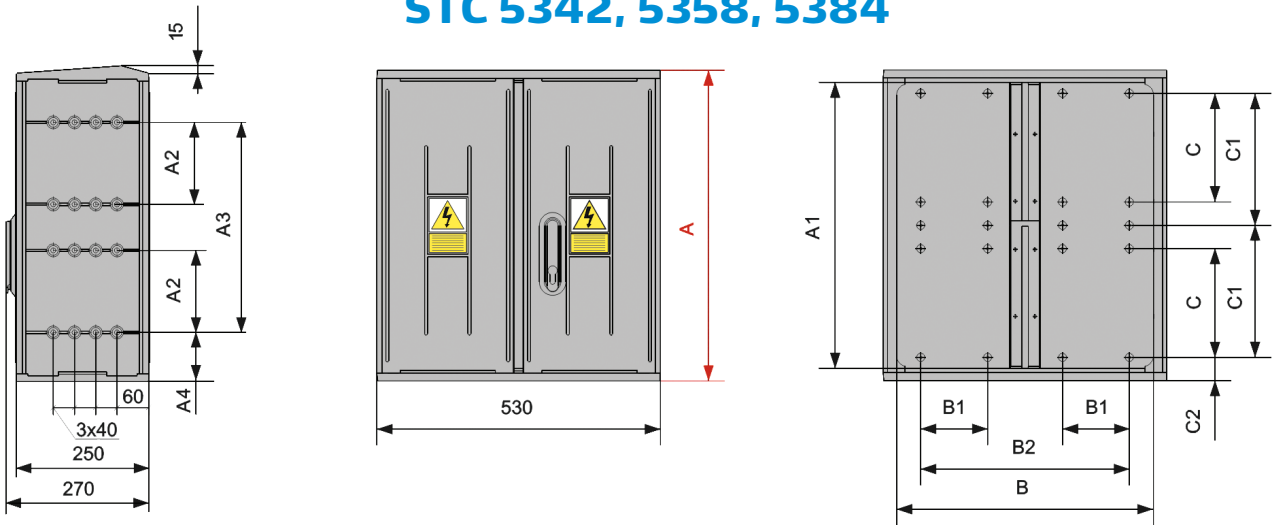

Type	A	A1	A2	A3	A4	B	B1	B2	C	C1	C2
STC 5342	420	374	-	235	92	480	125	390	-	166	43
STC 5338	580	534	-	395	92	480	125	390	-	246	43
STC 5384	840	794	235	-	92	480	125	390	333	-	43

5TC 5388/32

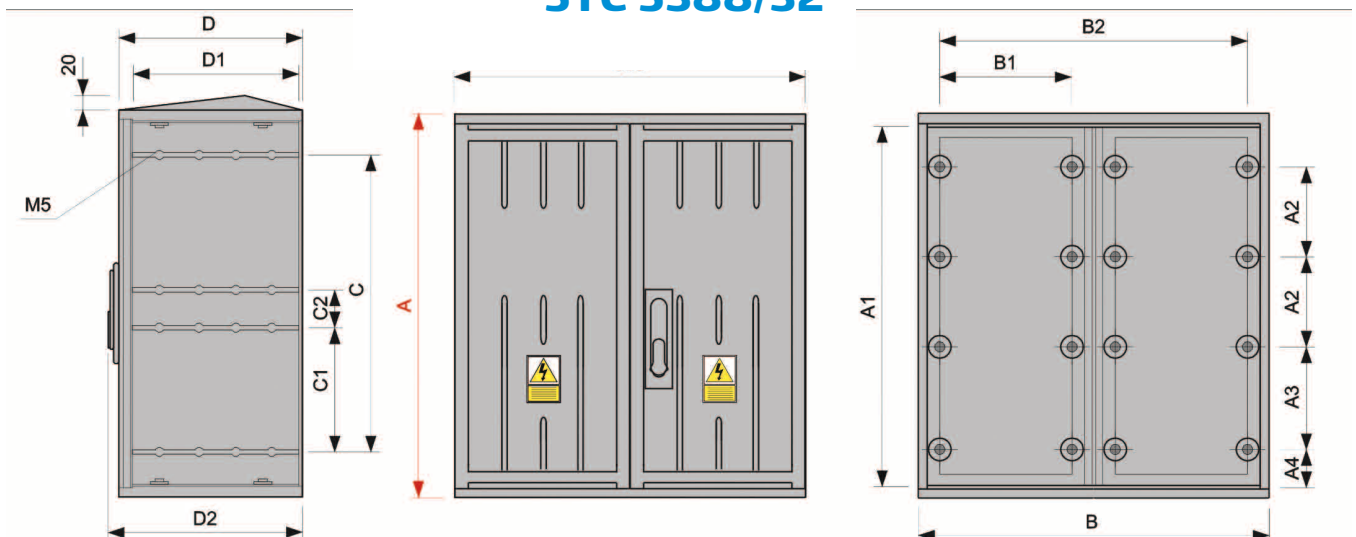

Type	A	A1	A2	A3	A4	B	B1	B2	C	C1	C2	D	D1	D2
STC 5388/32	880	840	185	240	75	490	190	455	675	235	205	320	295	340

STC 6644, 6657, 6688 STC 6688/32

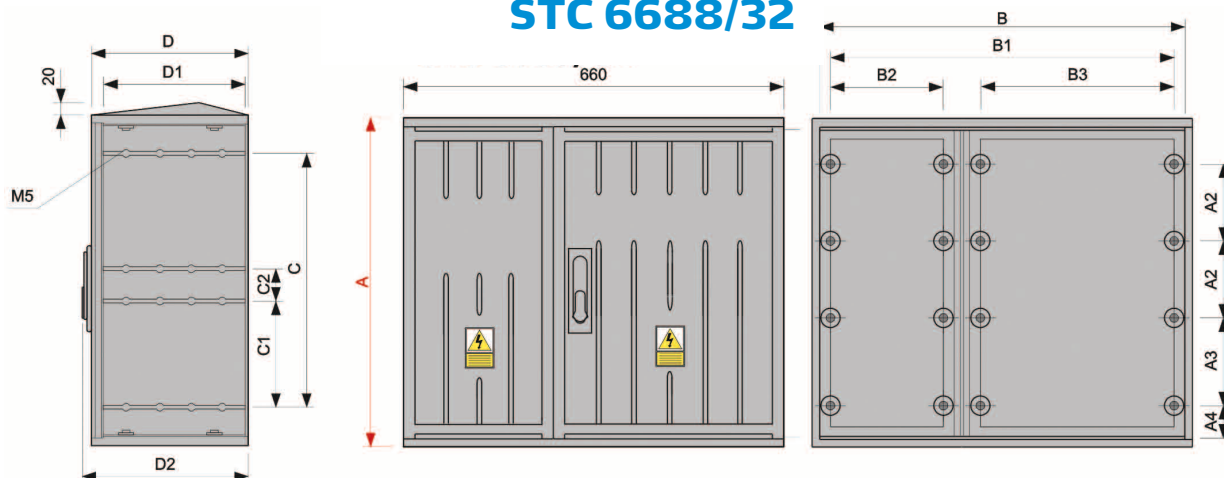

Type	A	A1	A2	A3	A4	B	B1	B2	B3	C	C1	C2	D	D1	D2
STC 6644	440	400	-	-	-	620	-	-	-	235	-	-	250	250	270
STC 6657	570	530	-	-	-	620	-	-	-	450	-	-	250	250	270
STC 6688	880	840	185	240	75	620	585	190	325	675	235	205	250	250	270
STC 6688/32	880	840	185	240	75	620	585	190	325	675	235	205	320	295	340

STC 8042, 8058, 8084

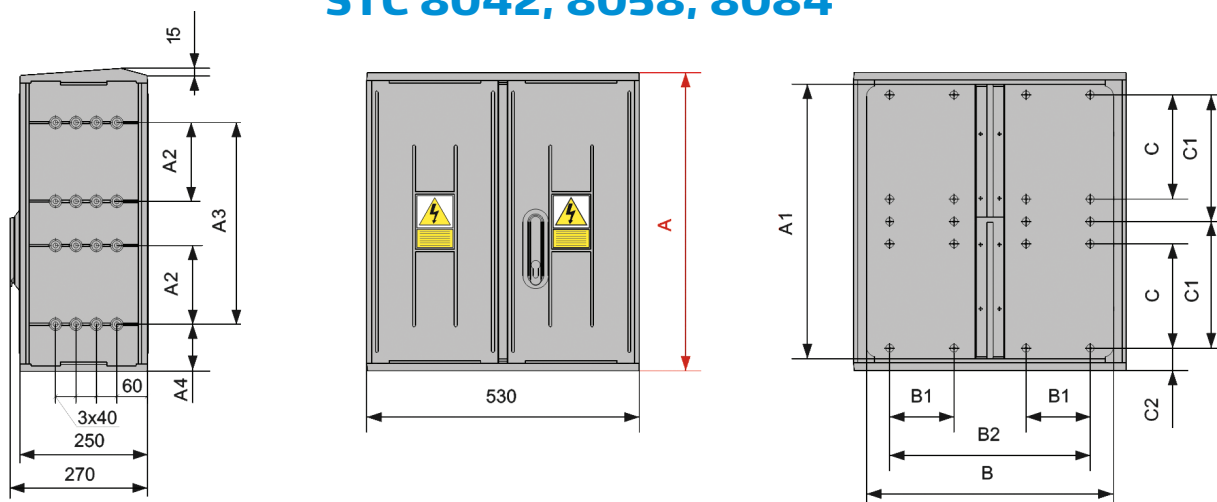

Type	A	A1	A2	A3	A4	B	B1	B2	C	C1	C2
STC 8042	420	374	-	235	92	480	125	390	-	166	43
STC 8058	580	534	-	395	92	480	125	390	-	246	43
STC 8084	840	749	235	-	92	480	125	390	333	-	43

www.fibox.dk

FIBOX A/S

Kuldysen 13 · 2630 Taastrup

Telefon: +45 43 71 80 55

Fax: +45 43 71 80 35

ordre@fibox.dk

www.fibox.dk