



teknisk belysnings industri a/s





Produktkatalog - Indholdsfortegnelse

A fbrydere	A - 1	K iplede	K - 1
Afbrydere	A - 2	K ugler: Kugler	K - 2
Aflastninger plast	A - 3	Kugler: Bundknapper	K - 3
Aflastninger plast	A - 4	L edningsholdere	L - 1
Aflastninger metal	A - 5	Ledningssæt	L - 2
Aflastninger	A - 6	Ledning 70 grader	L - 3
Aflastninger kabler.....	A - 7	Ledning 180 grader	L - 4
Aflastningsskruer	A - 8	L edning med tekstil rund	L - 5
B aldakiner	B - 1	Ledning med tekstil rund	L - 6
D iverse	D - 1	Ledning med tekstil snoet.....	L - 7
Drejeled og vægophæng	D - 2	Ledning med tekstil	L - 8
F atninger		M embrannipler	M - 1
E14 fatninger samlet	F - 1	Muffer metal	M - 2
E14 fatninger 3-delt termohærdende	F - 2	Muffer plast	M - 3
E14 fatninger klik og tilbehør	F - 3	Møtrikker	M - 4
E14 fatninger 3-delt termoplast	F - 4	Møtrikker facon	M - 5
E14 metalfatninger	F - 5	N ipler: -krave, lodde og ringnipler	N - 1
E14 diverse	F - 6	Nipler: reduktionsnipler	N - 2
E27 diverse	F - 6	O phæng	O - 1
E27 fatning samlet	F - 7	Ophæng	O - 2
E27 fatning 3-delt termohærdende	F - 8	Ophæng	O - 3
E27 fatning klik og tilbehør	F - 9	R ørnipler	R - 1
E27 fatning 3-delt termoplast	F - 10	Rørnipler	R - 2
E27 fatning 3-delt termoplast	F - 11	S kærme & Skærmstativer	S - 1
E27 metalfatninger	F - 12	Skiver	S - 2
E14, E27, E40, B22 porcelænsfatninger	F - 13	Stikpropper	S - 3
G4, G9, GX53 fatninger	F - 14	Stikpropper - UK adaptor	S - 4
GU10, GZ10, B15, B22 fatninger	F - 15	T yller, blindpropper	T - 1
G13, 2G11 fatninger	F - 16	Tyller, blindpropper	T - 2
G13, T5 fatninger	F - 17	Tyller, blindpropper	T - 3
Fatningsadaptore	F - 18	U SA – materiel 1	U - 1
F orgreningsmateriel	F - 19	USA – materiel 2 (E12 - E26)	U - 2
Forgreningsmateriel	F - 20	W iremateriale	W - 1
Forgreningsmateriel	F - 21	Wiremateriale	W - 2
Forskrninger	F - 22	Wiremateriale: Ophængningseksempler	W - 3
G las	G - 1	Wiremateriale: Ophængssæt	W - 4
H alogensæt	H - 1	Agenturer	
Hangtag og hætter	H - 2		
J ordblik	J - 1		

Temperaturer er angivet i grader celsius. - Der tages forbehold for trykfejl, konstruktions og materialeændringer.

Afbrydere 1

	Dæmper f/INC, CFL og LED
	ARD039133 hvid 10 stk. ARD038305 sort 10 stk. LFP: Integrated load failure protection. Dæmpning af glødelamper (4-150W), kompakte fluorescerende (11-25W) og LED (4-25W) dæmpbare lamper. 220-240V, 50-60Hz. Passer for 2x0,75 flad og rund ledning. 96,5x30,5x25 mm.

	Foddæmper f/INC, CFL og LED
	ARD039983 hvid 10 stk. ARD039982 sort 10 stk. LFP: Integrated load failure protection. Dæmpning af glødelamper (4-250W), kompakte fluorescerende (11-25W) og LED (4-25W) dæmpbare lamper. 220-240V, 50-60Hz. Passer for 2x0,75 flad og rund ledning. Ø100x29 mm.

	Dæmper f/glødelamper
	ARD027504 hvid 10 stk. ARD027503 sort 10 stk. ARD027505 transp. 10 stk. 230V, 10-150 watt. forbrug 0,04 watt. Passer for 2x0,75 flad og rund ledning.

	Fodafbryder
	ARD022566 hvid 250 stk. ARD022567 sort 250 stk. ARD022576 transp. 250 stk. ARD022569 hvid m/jord 250 stk. ARD022570 sort m/jord 250 stk. Ø65 mm. 2A, 250V, CE. Passer for 2x0,75 flad og rund ledning.

	Gennemgangsafbryder 1 pol.
	ARD028314 hvid 100 stk. ARD028315 sort 100 stk. ARD021423 transp. 100 stk. 2A, 250V. Passer for 2x0,75 flad og rund ledning.

	Fodafbryder
	972G0006 transp. 200 stk. Passer for 2x0,75 flad ledning. 972M0007 hvid 200 stk. 972M0008 sort 200 stk. Passer for 2x0,75 rund ledning. Ø75 mm, 30 mm høj. CE.











	Gennemgangsafbryder 1 pol.
	1266A0007 hvid 100 stk. 1266A0008 sort 100 stk. Ø25, 73 mm lang. 2A, 250V. CE. Passer for 2x0,75 flad og rund ledning.

	Fodafbryder
	971E0008 sort 250 stk. Ø68 mm, 32 mm høj, 2A, 250V. Passer for 2x0,75 flad og rund ledning.

	Gennemgangsafbryder 1 pol.
	1266B0007 hvid 100 stk. 1266B0008 sort 100 stk. 2A, 250V. Passer for 2x0,75 flad og rund ledning.

	Fodkontakt
	002F0007 hvid 200 stk. Ø65 mm.

Afbrydere 2

	<p>Trykafbryder 1-pol</p> <p>ARD027527 trykknop sort 1000 stk. ARD027528 trykknop hvid 1000 stk.</p> <p>250V, 2A vekselstrøm. 1A jævnstrøm. 21x12,5 mm. h = 30,5 mm. M10x1, gevindhøjde 9 mm. Med skrueklammer.</p>		<p>Møtrik 6-kt f/trykafbryder</p> <p>002C3036 messing 1000 stk.</p> <p>M10x1, NV 12x1,5 mm.</p>
	<p>Trykafbryder med omløber</p> <p>431B0107 hvid 50 stk. 431B0108 sort 50 stk.</p> <p>250V, 2A vekselstrøm. 1A jævnstrøm. 21x12,5 mm. h = 30,5 mm, M10x1, gevindhøjde 9 mm, Med skrueklammer.</p>		<p>Omløber M10 Ø12,5x9 mm</p> <p>041A0036 1000 stk.</p> <p>Messing.</p>
	<p>Trykafbryder 1-pol</p> <p>972F0107 hvid 1000 stk. 972F0108 sort 1000 stk.</p> <p>250V, 2A vekselstrøm. 24,6x12,8 mm. h = 24,8 mm. M10x1, gevindhøjde 9 mm. Med indstiksklemmer.</p>		<p>Omløber M10 f/trykafbryder</p> <p>ARD024120 hvid 1000 stk. ARD024121 sort 1000 stk.</p>
	<p>Trykafbryder 1-pol</p> <p>972F0207 hvid 1000 stk. 972F0208 sort 1000 stk.</p> <p>250V, 2A vekselstrøm. 24,6x12,8 mm. h = 30,2 mm. M10x1, gevindhøjde 9 mm. Med indstiksklemmer.</p>		<p>Trækafbryder med snor/knob</p> <p>1834A32708 100 stk.</p> <p>Med monteringsplade og 25 cm snor.</p>
	<p>Trykkontakt</p> <p>ARD024124 trykknop hvid 1000 stk.</p> <p>250V, 2A vekselstrøm. 1A jævnstrøm. 21x12,5 mm. h = 25,5 mm. M10x1, gevindhøjde 9 mm. Med skrueklammer.</p>		<p>Skabsafbryder hvid</p> <p>1833A0007 hvid 10 stk.</p> <p>50x52x18 mm.</p>
	<p>Vippeafbryder t/indbygning</p> <p>ARD029288 hvid 500 stk.</p> <p>27x17 mm. 2A, 250V, T125, CE.</p>		

Aflastninger plast

	Pinolaflastning M10u		
	430A0007 hvid		500 stk.
	430A0107 hvid		25 stk.
	430A0008 sort		500 stk.
	430A0108 sort		25 stk.
	Ø15x15 mm.		
	Termoplast, T110.		

	Klemnippel M10u		
	430G0007 hvid Ø6		1000 stk.
	430G0008 sort Ø6		1000 stk.
	430G0006 transp. Ø6		1000 stk.
	Gevindlængde M10 = 8 mm.		
	Termoplast, T120.		

	Pinolaflastning M10u		
	1820707 hvid L= 7 mm.		1000 stk.
	1820708 sort L= 7 mm.		1000 stk.
	1821008 sort L=10 mm.		1000 stk.
	L = gevindlængde M10.		
	Polyamid.		

	Omløber M10i		
	430G0077 hvid		1000 stk.
	430G0088 sort		1000 stk.
	430G0066 transp.		1000 stk.
	Termoplast, T120.		

	Pinolaflastning M10u		
	430K0807 hvid L= 8 mm.		1000 stk.
	430K0808 sort L= 8 mm.		1000 stk.
	430L1107 hvid L= 11 mm.		1000 stk.
	430L1108 sort L= 11 mm.		1000 stk.
	L = gevindlængde M10.		
	Huldiameter Ø7,2 mm.		
	Polyamid.		

	Klemnippel M10u		
	430G0107 hvid		25 stk.
	430G0108 sort		25 stk.
	Ø15x19 mm.		
	Termoplast, T120.		

	Pinolaflastning M10i		
	18906 transp.		1000 stk.
	18907 hvid		1000 stk.
	430B0107 hvid		25 stk.
	18908 sort		1000 stk.
	430B0108 sort		25 stk.
	Ø16x22 mm.		
	Polycarbonat.		

	Omløber M10x1i		
	430D0007 hvid		500 stk.
	430D0008 sort		500 stk.
	Ø19x20 mm.		
	Termoplast T140.		
	Polyamid m/glas.		

	Pinolaflastning m/styrerør M10i		
	430F0007 hvid		500 stk.
	Ø15x25 mm.		
	Polycarbonat.		

	Klemnippel 2 delt M10u		
	19407 hvid		1000 stk.
	19408 sort		1000 stk.

	Klemnippel M10i		
	ARD027236 hvid		1000 stk.
	ARD027237 sort		1000 stk.
	Gevindlængde M10 = 8 mm.		

	Klemnippel 2 delt M10i		
	19507 hvid		1000 stk.
	19508 sort		1000 stk.

Aflastninger plast

	Omløber M10x1i 430D0007 hvid 500 stk. 430D0008 sort 500 stk. Ø19x20 mm. Termoplast T140. Polyamid m/glas.
---	---

	Pinolafastning M13i 19007 hvid 500 stk. M13x1 mm. Ø20x22,5 mm. Hul Ø8,5 mm. Polycarbonat.
--	--

	E27 bund ASS ARD031794 hvid 500 stk. ARD031793 sort 500 stk. Ø37,5x16,5 mm. T190, 4A, 250V, CE. Termoplast.
---	---

	Pinolafastning M13i 177107 hvid 500 stk. 177108 sort 500 stk. M13x1 mm. Ø19,5x20 mm. Hul Ø10,7 mm. Termoplast.
--	--

	Aflastning TS 430E0006 natur 500 stk. Polyamid.
--	--

	Nippel M13u 189607 hvid 500 stk. 189608 sort 500 stk. Termoplast.
---	---

	Nippel M10 430P0007 500 stk. Kan anvendes til aflastning af bæ- træde.
---	--

	Aflastningsring f/rør 13 mm. 381307 hvid 500 stk. Termoplast. Bruges sammen med aflastninger 182070. Kan også fås til 16 mm. rør.
--	---

Aflastninger metal

	Aflastning metal M10i	
	430Y0008 sort forniklet	250 stk.
	430Y0019 forniklet	250 stk.
	430Y0036 messing rå	250 stk.
	430Y0051 kobber	250 stk.
Messing, isoleringsindsats PC. Kl.2. Aflastningsskrue M7 hvid/sort. Låseskrue M3. Ø13x18 mm. Ledningshul Ø6,9 mm.		

	Overfladebelægning	
	Sort forniklet	
	Forniklet	
	Messing rå	
	Kobber	

	Aflastning metal M10i	
	430R0519 forniklet / grå skrue	250 stk.
	430R0036 messing rå	250 stk.
	430R0038 forkromet	250 stk.
	Messing, isoleringsindsats PC. Kl.2. aflastningsskrue M7 hvid. Låseskrue M3. Ø14x24 mm. Ledningshul Ø7,0 mm.	

	Aflastning metal M10i/ M10i	
	430X0008 sort forniklet	250 stk.
	430X0036 messing rå	250 stk.
	430X0519 forniklet	250 stk.
	430X0038 forkromet	250 stk.
Messing, isoleringsindsats PC. Kl.2. Aflastningsskrue M7 hvid/grå. 2 stk. låseskruer M3. Ø13x26 mm. Ledningshul Ø6,9 mm.		

	Aflastning metal M10u	
	429B0019 forniklet	250 stk.
	429B0519 forniklet / grå skrue	250 stk.
	429B0036 messing	250 stk.
	Messing, isoleringsindsats PC. Kl. 2. Aflastningsskrue M7 hvid. Ø13x23 mm. Ledningshul Ø7 mm.	

	Aflastning metal M10u		
	430S0019 forniklet	250 stk.	
	430S0036 messing rå	250 stk.	
	Messing, isoleringsindsats PC. Kl. 2. Aflastningsskrue M7 hvid. Ø14x24 mm. Ledningshul Ø7 mm.		

	Aflastning metal M13u		
	430T0019 forniklet	250 stk.	
	430T0036 messing rå	250 stk.	
	Messing, isoleringsindsats PC. Kl.2. Aflastningsskrue M7 hvid. Ø16x25 mm. Ledningshul Ø8,2 mm.		

	Aflastning metal M10i/M10u		
	430V0036 messing rå	250 stk.	
	Messing, isoleringsindsats PC. Kl.2. aflastningsskrue M7 hvid. Låseskrue M3. Ø13x27 mm. Ledningshul Ø6,9 mm.		

	Aflastning metal M13i		
	430U0019 forniklet	250 stk.	
	430U0036 messing rå	250 stk.	
	Messing, isoleringsindsats PC. Kl.2. Aflastningsskrue M7 hvid. Låseskrue M3. Ø16x25 mm. Ledningshul Ø8,2 mm.		

	Aflastning metal M10i/ M10i		
	430Z0036 messing rå	250 stk.	
	Messing, isoleringsindsats PC. Kl.2. Aflastningsskrue 2xM7 hvid. 2 stk. låseskruer M3. Ø13x31 mm. Ledningshul Ø6,9 mm.		

	Aflastning metal M13i/M13u		
	430Q0019 forniklet/ grå skrue	250 stk.	
	430Q0036 messing rå	250 stk.	
	Messing, isoleringsindsats PC. Kl.2. aflastningsskrue M7 hvid/grå. Låseskrue M3. Ø16x28 mm. Ledningshul Ø7,0 mm.		

Aflastninger

	Aflastningsbro	
	170506 natur	1000 stk.
	22,5x8,5 mm. Centerafstand 16 mm. Polypropylen.	

	Isolationsplade	
	1366K0006	1000 stk.
	24x8x0,4 mm. Centerafstand 16 mm. 2xØ4mm Folie. CE, UL.	

	Aflastningsbro CL16	
	1701A170310 hvid	1000 stk.
	1701A170320 sort	1000 stk.
22,8x7,3x3 mm. Centerafstand 16 mm. Polyamid.		

	Aflastning 2 hulls	
	622407 hvid PP	1000 stk.
	622407 hvid PA66	1000 stk.
18x10x2 mm. Termoplast.		

	Aflastningsbro CL16	
	1701A170207 natur	1000 stk.
	22,8x7,3x4,5 mm. Centerafstand 16 mm. Polyamid.	

	Aflastning 2-huls rund	
	622507 hvid	1000 stk.
	16,5x10 mm. Centerafstand 7 mm. Termoplast.	

	Aflastningsbro CL20 hvid	
	1701A170401 PA	1000 stk.
	1705A70407 PP	1000 stk.
30x10,2 mm. 1705A70407 Centerafstand 20 mm.		

	Aflastning PSSC/S/27	
	ARD012744 hvid	500 stk.
	For flad ledning.	

	Aflastningsbro	
	432E4107 hvid	1000 stk.
	432E4108 sort	1000 stk.
29x8 mm. M/ledningsstyr. Centerafstand 20,3 mm. Polyacetal.		

	Trækafastning	
	430M0006 natur	1000 stk.
	Anvendes sammen med E14 og E27 isolerindsats. Passer for 2 og 3 delte fatninger E14 og E27. Polyamid.	

	Aflastning f/rør Ø10 mm.	
	430C0007 hvid	500 stk.
	M/ledningsstyr. Inkl. selvskærende skruer. Fås også for Ø13 mm. rør. Polyacetal.	

Aflastninger kabel

	<p>Kabelafastning SP1 432K0106 grå 10 stk.</p> <p>Enkeltkæde el-galv. stål. Kabeldimensioner Ø7-Ø13 mm. Polypropylen.</p>
---	--

	<p>Kabelafastning SP1 rustfri 432K0124 rustfri 10 stk.</p> <p>Enkeltkæde rustfri. Kabeldimensioner Ø7-Ø13 mm. Polypropylen.</p>
--	--

	<p>Kabelafastning SP2 432L0106 grå 10 stk.</p> <p>Dobbeltkæde el-galv. stål. Kabeldimensioner Ø13-Ø16 mm. Polypropylen.</p>
---	--

	<p>Kabelafastning SP2 rustfri 432L0124 rustfri 10 stk.</p> <p>Enkeltkæde rustfri. Kabeldimensioner Ø13-Ø16 mm. Polypropylen.</p>
--	---

	<p>Kabelafastning SP3 432M0106 grå 10 stk.</p> <p>Dobbeltkæde el-galv. stål. Kabeldimensioner Ø13-Ø26 mm. Polypropylen.</p>
--	--

	<p>Kabelafastning SP3 rustfri 432M0124 rustfri 10 stk.</p> <p>Enkeltkæde rustfri. Kabeldimensioner Ø13-Ø26 mm. Polypropylen.</p>
--	---

Aflastningsskruer

	Aflastningsskrue M6x1 mm.		
	M6x606 transp.	6 mm. PC	1000 stk.
	M6x607 hvid	6 mm. POM	1000 stk.
	M6x608 sort	6 mm. PA	1000 stk.
	M6x807 hvid	8 mm. PA	1000 stk.
	M6x808 sort	8 mm. PA	1000 stk.
	M6x108 sort	10 mm. PA	1000 stk.

	Aflastningsskrue 1/4" WG	
	430A4107 hvid	1000 stk.
	430A4108 sort	1000 stk.
	10 mm. lang. Polyacetal.	

	Aflastningsskrue M7x1 mm.		
	M7x706 natu	7 mm.	1000 stk.
	M7x707 hvid	7 mm.	1000 stk.
	M7x708 sort	7 mm.	1000 stk.
	M7x906 natur	9 mm.	1000 stk.
	M7x907 hvid	9 mm.	1000 stk.
	M7x908 sort	9 mm.	1000 stk.
Polyacetal.			

	Aflastningsskrue M7x1 mm.	
	ARD023107 hvid	1000 stk.
	11 mm. lang. Polyamid.	

	Pinolskrue M3	
	M3X329 Fzb.	250 stk.
	M3X340 Fzb. sort	250 stk.
	Med 6 kant. 3 mm. lang. Jern.	

Baldakiner

	Baldakin mini 001208 sort m/ophæng 1000 stk. Ø21x37 mm. Ledningshul Ø4,5 mm. Polycarbonat.
---	---

	Baldakin Ø110x72 mm. ARD023108 hvid 200 stk. M7x907. M7 skrue hvid 200 stk. ARD023109 sort 200 stk. M7x908. M7 skrue sort 200 stk. Ledningshul Ø7 mm., UL. Termoplast.
--	---

	Baldakin Ø85x80 mm. 12007 hvid 1400 stk. 12008 sort 1400 stk. Selvbærende på 2x0,75 mm ² PKL. Polyethylen.
---	--

	Baldakin Ø125x87 mm. ARD013160 hvid 200 stk. M6x807. M6 skrue hvid 200 stk. ARD013143 sort 200 stk. M6x808. M6 skrue sort 200 stk. Ledningshul Ø7 mm., UL. Termoplast.
--	---

	Baldakin Ø90x87 mm. 412B0006 transp. 700 stk. 412B0007 hvid 700 stk. 412B0008 sort 700 stk. 412B0107 hvid 25 stk. 412B0108 sort 25 stk. Selvbærende på 2x0,75 mm ² PKL. Polyethylen.
--	---

	2-delt baldakin 412C0007 hvid 300 stk. 412C0008 sort 300 stk. Ø90 mm., høj 87 mm. ABS. Patenteret.
---	--

	Baldakinophæng 412E0007 hvid 50 stk. Sammen med baldakin skjuler den let udtag eller lignende i loft.
---	--

	Baldakinsæt 916B0007 baldakin hvid 700 stk. 916B0107 baldakin hvid 25 stk. 916B0008 baldakin sort 700 stk. 916B0108 baldakin sort 25 stk. Bestående af: baldakin. 431A0029 loftkrog. 20004 pendelophæng kl. 2. 135/2 klemrække 2-polet 4,0 mm ² .
---	--

	Ophængssæt for pendel 916A0006 500 stk. 916A0106 25 stk. Bestående af: 431A0029 loftkrog. 20004 pendelophæng kl. 2. 135/2 klemrække 2-polet 4,0 mm ² .
--	--

Diverse

	Trækbøjle til hejs 21007 hvid 250 stk. 160x100 mm., Ø40,5 hul. Polypropylen forstærket med talkum.
---	--

	Centerroset 93007 hvid M10 1000 stk. 93507 hvid M5 1000 stk. Ø60 mm. Termoplast.
--	---

	Trækbøjle til hejs 21107 hvid 250 stk. 160x190 mm., Ø40,5 hul. Polypropylen forstærket med talkum.
---	--

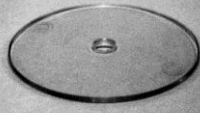
	Plastskive Ø100x3,5 mm. 100-10-006 Transp. 500 stk. Polystyren.
--	--

	Nylonvrider 1465A0006 natur 1000 stk. Vrider til forsatsvindue, låge/luge mv. Indvendige hul: Ø5,9x10,80 mm. Nylon.
---	--

	Plast boks Stor 212x113x35 mm. 1000 stk. Mellem 149x99x34 mm. 1000 stk. Lille 90x64x26 mm. 1000 stk. Sort og transparent. Kan evt. fremstilles i andre farver.
---	--

	Wattmærker 867A0040 sort max 40W 1000 stk. 867A0060 sort max 60W 1000 stk. 867A0075 sort max 75W 1000 stk. 867A1060 hvid max 60W 1000 stk. 867A1075 hvid max 75W 1000 stk. Ø13 mm.
---	---

	Røde håndtag 14 rød 2000 stk. Ø30x133 mm. Tophul: Ø8 mm. Indvendig hul: Ø16x114 mm. Termoplast.
--	---

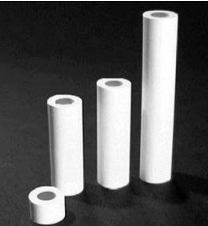
	Afstandsør Ø7,5/Ø4,1 mm. 7100507 hvid 5 mm. 1000 stk. 7101007 hvid 10 mm. 1000 stk. 7101507 hvid 15 mm. 1000 stk. 7102007 hvid 20 mm. 1000 stk. 7102507 hvid 25 mm. 1000 stk. 7103007 hvid 30 mm. 1000 stk. 7103507 hvid 35 mm. 1000 stk. 7104007 hvid 40 mm. 1000 stk. 7104507 hvid 45 mm. 1000 stk. ABS
---	--

	Klæbefod 17x17 mm. 30308 sort 3 mm. høj. 30808 sort 8 mm. høj. 31006 klar 10 mm. høj. 31007 hvid 10 mm. høj. 31008 sort 10 mm. høj. Selvklæbende.
--	--

Drejeled og vægophæng

	Vægophæng til 1 stk. slangearm	
	91507 hvid	1000 stk.
	91508 sort	1000 stk.
Aflastning på bagsiden. ABS.		

	Paralleled til rør	
	82608 Ø13/Ø16 mm sort	1000 stk.
	Med bolt og møtrik. ABS.	

	Vægophæng til 2 stk. slangearm	
	91007 hvid	1000 stk.
	2 firkantede huller til vippeafbrydere. ABS.	

	Paralleled til rør	
	92307 Ø10/Ø13 mm hvid	1000 stk.
	92407 Ø13/Ø13 mm hvid	1000 stk.
ABS.		

	Drejeled til gulv- bordlampe	
	9280735 hvid	500 stk.
	Til rørformet skærm Ø70 mm. Drejeled radius 35. L = 125 mm. Ø24 mm. ABS.	

	Drejeled	
	81307 hvid	1000 stk.
	81308 sort	1000 stk.
	Stopplade til 813	
	81207 hvid	1000 stk.
	81208 sort	1000 stk.
ABS/Polycarbonat.		

	Drejeled Ø13x100 mm.	
	9160713 hvid	500 stk.
	9160813 sort	500 stk.
Til Ø13 mm. rør. ABS/Polycarbonat.		

	Skiveled til rør	
	90307 Ø10/Ø13 mm hvid	1000 stk.
	90308 Ø10/Ø13 mm sort	1000 stk.
ABS.		

E14 fatninger samlet

	Fatning E14 M10 glat	
	300A0107 hvid	100 stk.
	300A0108 sort	100 stk.
	2A, 250V, Ø27x53 mm. Termoplast, T190.	

	Fatning E14 M10 1/1 gevind	
	300B0107 hvid	25 stk.
	300B0108 sort	25 stk.
	2A, 250V, Ø27x53 mm. Termoplast, T190.	

	E14 omløbsring Ø35 mm.	
	301A0107 hvid	25 stk.
	301A0108 sort	25 stk.
	Termoplast.	

	Fatning E14 M10 1/1 gevind + 2 omløbsringe	
	300C0107 hvid	100 stk.
	300C0108 sort	100 stk.
	2A, 250V, Ø27x53 mm. Termoplast, T190.	

	Fatning E14 M10 glat	
	610A0007 hvid	100 stk.
	610A0008 sort	100 stk.
	2A, 250V, Ø27x53 mm. Termohærdende, T190.	

E14 fatninger 3-delt termohærdende

	<p>E14 indlæg m/indstik ARD040655 1000 stk.</p> <p>Med indstiksklemmer. T180, 2A, 250V, CE</p>		<p>E14 kappe glat ARD000694 hvid 1000 stk. ARD040284 sort 1000 stk. ARD000582 guld 1000 stk.</p> <p>Ø27x37,5 mm. T190, 2A, 250V, CE. Termohærdende.</p>
	<p>E14 indlæg m/skrueklemme ARD040656 1000 stk.</p> <p>Med skrueklemmer. T180, 2A, 250V, CE.</p>		<p>E14 kappe 1/1 gevind ARD000592 hvid 1000 stk. ARD000591 sort 1000 stk.</p> <p>Ø28x37,5 mm. T190, 2A, 250V, CE. Termohærdende.</p>
	<p>E14 bund M10 ARD000654 hvid 1000 stk. ARD000638 sort 1000 stk. ARD000686 guld 1000 stk.</p> <p>Med M10 nippel i metal. Ø28x15 mm. T190, 2A, 250V, CE. Termohærdende.</p>		<p>E14 kappe 1/2 gevind ARD000604 hvid 1000 stk. ARD000603 sort 1000 stk.</p> <p>Ø34/Ø28x37,5 mm. T190, 2A, 250V, CE. Termohærdende.</p>
	<p>E14 bund ASS ARD007699 hvid 1000 stk. ARD007279 sort 1000 stk.</p> <p>Ø28x15 mm. T190, 2A, 250V, CE. Termohærdende.</p>		<p>E14 omløbsring Ø35 mm. ARD012260 hvid 1000 stk. ARD012261 sort 1000 stk.</p> <p>Termoplast.</p>
	<p>E14 isoleringsindsats kl. 2. E14F-PA66 PA66 hvid 1000 stk. E14F PP natur 1000 stk.</p>		<p>E14 omløbsring Ø43 mm. ARD012422 hvid 1000 stk. ARD012423 sort 1000 stk. ARD021353 transp. 100 stk.</p> <p>Termoplast.</p>

E14 fatninger klik og tilbehør

	E14 klik bund M10 ASFV	
	ARD031898 hvid	1000 stk.
	ARD021344 transp.	100 stk.
Med M10 i plast. Ø26,5x15 mm. T180, 2A, 250V, CE. Termoplast.		

	E14 klik fatning glat	
	ARD023977 hvid	1000 stk.
	ARD023978 sort	1000 stk.
ARD021450 transp. 100 stk. Ø26,5x43,5 mm. T180, 2A, 250V, CE. Termoplast.		

	E14 klik bund M10 NIP	
	ARD012110 hvid	1000 stk.
	ARD012338 sort	1000 stk.
Med M10 i metal. Ø26,5x15 mm. T180, 2A, 250V, CE. Termoplast.		

	E14 klik fatning 1/1 gevind	
	ARD023983 hvid	1000 stk.
	ARD021833 transp.	100 stk.
Ø28x43,5 mm. T180, 2A, 250V, CE. Termoplast.		

	E14 klik bund for aflastning	
	ARD015775 hvid	1000 stk.
	Ø26,5x15 mm. T180, 2A, 250V, CE. Termoplast.	

	E14 klik fatning 1/2 gevind	
	ARD023989 hvid	1000 stk.
	Ø28x43,5 mm. T180, 2A, 250V, CE. Termoplast.	

	SIB14 aflastning f/flad ledning	
	ARD016622	2000 stk.
	For 3 delte fatninger kl. 2. Passer i metalrør med indvendig Ø6,5-Ø6,8. Termoplast.	

	E14 isoleringsindsats kl. 0.	
	E14E-PA66	PA66 hvid 1000 stk.
	E14E	PE natur 1000 stk.

	SDI14 aflastning f/flad ledning	
	ARD024876	2000 stk.
	For klik E14 fatninger kl. 2. Passer i metalrør med indvendig Ø6,5-Ø6,8. Termoplast.	

	SDIR14 aflastning f/rund ledning	
	ARD027252	2000 stk.
	For klik E14 fatninger kl. 2. Passer i metalrør med indvendig Ø6,5-Ø6,8. Termoplast.	

E14 fatninger 3-delt termoplast

	E14 indlæg m/indstik	
	ARD040655	1000 stk.
	Med indstiksklemmer. T180, 2A, 250V, CE.	

	E14 kappe glat	
	ARD019045 hvid	1000 stk.
	ARD019046 sort	1000 stk.
Ø27x37,5 mm. T190, 2A, 250V, CE. Termoplast.		

	E14 indlæg m/skrueklemmer	
	ARD040656	1000 stk.
	Med skrueklemmer. T180, 2A, 250V, CE.	

	E14 kappe 1/1 gevind	
	ARD019047 hvid	1000 stk.
	ARD019050 sort	1000 stk.
Ø28x37,5 mm. T190, 2A, 250V, CE. Termoplast.		

	E14 bund M10	
	ARD019662 hvid	1000 stk.
	ARD019663 sort	1000 stk.
Med M10 nippel i metal. Ø26x15,5 mm. T190, 2A, 250V, CE. Termoplast.		

	E14 kappe 1/2 gevind	
	ARD019051 hvid	1000 stk.
	ARD019052 sort	1000 stk.
Ø27/Ø33,5x37,5 mm. T190, 2A, 250V, CE. Termoplast.		

	E14 Bund M10 ASFV TP	
	ARD028029 hvid	1000 stk.
	ARD028030 sort	1000 stk.
Med M10 gevind. T190, 2A, 250V, CE. Termoplast.		

	E14 omløbsring Ø35 mm.	
	ARD012260 hvid	1000 stk.
	ARD012261 sort	1000 stk.
Termoplast.		

	E14 isoleringsindsats kl. 2.	
	E14D-PA66 PA66 hvid	1000 stk.
	E14D PP natur	1000 stk.

	E14 omløbsring Ø43 mm.	
	ARD012422 hvid	1000 stk.
	ARD012423 sort	1000 stk.
ARD021353 transp. 100 stk. Termoplast.		

	E14 isoleringsindsats kl. 0.	
	E14E-PA66 PA66 hvid	1000 stk.
	E14E PE natur	1000 stk.

	E14 isoleringsindsats	
	E14G PA66 sort	1000 stk.

E14 metalfatninger

	<p>E14 bund M10 metal ARD028012 messing 1000 stk. Ø25x23 mm. 2A, 250V, 230°C, CE. Metal.</p>
---	---

	<p>E14 bund M10 metal ARD028013 hvid zink 1000 stk. Ø25x23 mm. 2A, 250V, 230°C, CE. Metal.</p>
--	---

	<p>E14 isolerdel f/metal ARD019578 sort 1000 stk. Termoplast.</p>
---	--

	<p>E14 indlæg f/metal ARD033704 med jord 1000 stk. 2A, 230V, 230°C, CE. PPS.</p>
---	---

	<p>E14 kappe 1/1 gevind metal ARD033992 messing 1000 stk. Ø28x39 mm. 2A, 230V, 230°C, CE. Metal</p>
---	--

	<p>E14 kappe 1/1 gevind metal ARD033993 hvid zink 1000 stk. Ø28x39 mm. 2A, 230V, 230°C, CE Metal.</p>
--	--

	<p>E14 omløbsring Ø42,5 metal ARD016700 messing 1000 stk. Ø42,5x11 mm. Metal.</p>
---	--

	<p>E14 omløbsring Ø42,5 metal ARD016701 hvid zink 1000 stk. Ø42,5x11 mm. Metal.</p>
--	--

E14 diverse

	E14 fatning t/indbyg ARD009712 sort 1000 stk. Ø23,5x41,5 mm. 2A, 250V. Termoplast.
---	---

	E14 fatningsbøjle M10 ARD009963 65 mm. 1000 stk. ARD009964 85 mm. 1000 stk. ARD009965 100 mm. 1000 stk. Metal.
---	---

	E14 imitationslys hvid ARD012016 hvid 85 mm. 500 stk. Ø26 mm. Termoplast.
--	---

	E14 imitationslys hvid m/dråbe ARD012860 hvid 65 mm. 500 stk. ARD012861 hvid 85 mm. 500 stk. Ø26 mm. Termoplast.
---	---

	E14 imitationslys antik m/dråbe ARD014731 antik 65 mm. 500 stk. ARD014732 antik 85 mm. 500 stk. ARD014733 antik 85 mm. 500 stk. Ø26 mm. Termoplast.
---	---

	E14 kertelys hvid 1564A0007 med indsats 100 stk. 1564B0007 rør 100 stk. Ø30 mm., 85 mm. Indsats med M7x1 mm. skrue. Termoplast.
---	---

E27 diverse

	E27 loftfatning 330A0007 hvid 200 stk. Bund Ø83 mm. Top Ø42 mm. Højde 58 mm.
--	---

	E27 vægfatning 330B0007 hvid 200 stk. Bund Ø83 mm. Top Ø42 mm. Højde 81 mm.
--	--

	E27 loftarmatur 330G0007 hvid 120 stk. Ø97mm, højde 55 mm. 84,5 mm gevind. Normaltæt IP20. Max 60W. All-round armatur for opal kugle eller staldglas.
---	---

	E27 vægarmatur 330H0007 hvid 120 stk. Ø97mm, højde 70 mm. 84,5 mm gevind. Normaltæt IP20. Max 60W. All-round armatur for opal kugle eller staldglas.
--	--

E27 fatninger samlet

	Fatning E27 M10 glat	
	315A0107 hvid	50 stk.
	315A0108 sort	50 stk.
	4A, 250V, Ø39x54 mm. Termoplast, T190.	

	Fatning E27 M10 1/1 gevind M/afbryder	
	325B0107 hvid	50 stk.
	325B0108 sort	50 stk.
	2A, 250V, Ø40x78 mm. Termohærdende, T190.	

	Fatning E27 M10 1/1 gevind	
	315B0107 hvid	50 stk.
	315B0108 sort	50 stk.
	4A, 250V, Ø40x54 mm. Termoplast, T190.	

	Fatning E27 M10 glat M/afbryder	
	325A0107 hvid	50 stk.
	325A0108 sort	50 stk.
	2A, 250V, Ø39x78 mm. Termohærdende, T190.	

	Fatning E27 M10 1/1 gevind + 2 omløbsringe	
	680D0007 hvid	250 stk.
	680D0008 sort	250 stk.
	4A, 250V, Ø40x54 mm. Termohærdende, T190.	

	Fatning E27 M10 1/2 gevind M/afbryder + 1 omløbsring	
	670C0007 hvid	250 stk.
	670C0008 sort	250 stk.
	2A, 250V, Ø40x78 mm. Termohærdende, T190.	

	Fatning E27 glat m/aflastning	
	315E0107 hvid	50 stk.
	315E0108 sort	50 stk.
	4A, 250V, Ø39x74 mm. Termoplast, T190.	

	Fatning E27 M10 1/1 gevind M/afbryder + 2 omløbsringe	
	675D0007 hvid	50 stk.
	675D0008 sort	50 stk.
	2A, 250V, Ø40x78 mm. Termohærdende, T190.	

	Omløbsring E27 Ø57 mm.	
	316B0107 hvid	25 stk.
	316B0108 sort	25 stk.
	Ø57x12 mm. Termoplast.	

	Omløbsring E27 Ø47 mm.	
	316A0107 hvid	25 stk.
	316A0108 sort	25 stk.
	Ø47x9 mm. Termoplast.	

	Fatning E27 M10 1/1 gevind zink + 2 omløbsringe	
	685A0029 zink	50 stk.
		4A, 250V, Ø60x56 mm. Metal, T230.

	Fatning E27 M10 1/1 gevind messing + 2 omløbsringe	
	685A0036 messing	50 stk.
		4A, 250V, Ø60x56 mm. Metal, T230.

	Fatning E27 M10 1/1 gevind kobber + 2 omløbsringe	
	685A0051 kobber	50 stk.
		4A, 250V, Ø60x56 mm. Metal, T230.

E27 fatning 3-delt termohærdende

	<p>E27 indlæg m/ skrueklemmer TP ARD040318 500 stk.</p> <p>Med skrueklemmer. T180, 4A, 250V, CE.</p>		<p>E27 indlæg m/vip-afbryder ARD031808 hvid 500 stk. ARD031807 sort 500 stk.</p> <p>2A, 250V, CE. Med skrueklemmer.</p>
	<p>E27 indlæg m/indstik TP ARD040317 500 stk.</p> <p>Med indstiksklemmer. T180, 4A, 250V, CE.</p>		<p>E27 bund M10 f/vip-afbryder ARD011318 hvid 500 stk. ARD011125 sort 500 stk.</p> <p>Ø37,5x40,5 mm. T190, 4A, 250V, CE. Termohærdende.</p>
	<p>E27 bund M10 ARD001247 hvid 500 stk. ARD001246 sort 500 stk. ARD001249 guld 500 stk.</p> <p>Med M10 nippel i metal. Ø37,5x16,5 mm. T190, 4A, 250V, CE. Termohærdende.</p>		<p>E27 kappe glat ARD007293 hvid 500 stk. ARD040548 sort 500 stk. ARD007286 guld 500 stk.</p> <p>Ø39x37,5 mm. T190, 4A, 250V, CE. Termohærdende.</p>
	<p>E27 Bund M10 m/sidehul ARD001294 sort 500 stk. ARD001295 hvid 500 stk.</p> <p>Med M10 nippel i metal. Ø37,5x16,5 mm. T190, 4A, 250V, CE. Termohærdende.</p>		<p>E27 kappe 1/1 gevind ARD007272 hvid 500 stk. ARD040818 sort 500 stk.</p> <p>Ø40x37,5 mm. T190, 4A, 250V, CE. Termohærdende.</p>
	<p>E27 bund ASS ARD007446 hvid 500 stk. ARD007559 sort 500 stk.</p> <p>Ø37,5x16,5 mm. T190, 4A, 250V, CE. Termohærdende.</p>		<p>E27 kappe 1/2 gevind ARD007271 hvid 500 stk. ARD040819 sort 500 stk.</p> <p>Ø40/Ø46x37,5 mm. T190, 4A, 250V, CE. Termohærdende.</p>
	<p>E27 isoleringsindsats kl. 2. E27D-PA66 PA66 hvid 1000 stk. E27D PP natur 1000 stk.</p>		<p>SDI27 aflastning f/flad ledning ARD024876 2000 stk.</p> <p>For E27 3-delte fatninger kl. 2. med indlæg ARD040318 eller ARD040317. Passer i metalrør Ø6,5i/Ø6,8i. Termoplast.</p>
	<p>E27 isoleringsindsats kl. 2. E27E-PA66 PA66 hvid 1000 stk.</p>		

E27 fatning klik og tilbehør

	E27 klik bund M10 asfv		
	ARD029697 hvid	500 stk.	
	ARD029696 sort	500 stk.	
	Ø38x17 mm. T180, 4A, 250V, CE. Termoplast.		

	E27 klik fatning glat		
	ARD019487 hvid	500 stk.	
	ARD019485 sort	500 stk.	
	Ø38x43,5 mm. T180, 4A, 250V, CE. Termoplast.		

	E27 klik bund M10 nip		
	ARD028235 hvid	500 stk.	
	ARD028236 sort	500 stk.	
	Med M10 nippel i metal. Ø38X17 mm. T180, 4A, 250V, CE. Termoplast.		

	E27 klik fatning 1/1 gevind		
	ARD019491 hvid	500 stk.	
	ARD019492 sort	500 stk.	
	Ø40x43,5 mm. T180, 4A, 250V, CE. Termoplast.		

	E27 klik bund M10 nip m/jord		
	ARD011295 hvid m/jord	500 stk.	
	ARD011296 sort m/jord	500 stk.	
	Med M10 nippel i metal. Ø38X17 mm. T180, 4A, 250V, CE. Termoplast.		

	E27 klik fatning 1/2 gevind		
	ARD024080 hvid	500 stk.	
	ARD024081 sort	500 stk.	
	Ø40/Ø45x43,5 mm. T180, 4A, 250V, CE. Termoplast.		

	E27 klik bund f/aflastning		
	ARD038266 hvid	500 stk.	
	Passer for ARD027103 og ARD023964.		

	SDI27 aflastning f/flad ledning		
	ARD023964	1000 stk.	
	For E27 klik fatning kl. 2. Passer i metalrør indvendig Ø6,5/Ø6,8. Termoplast.		

	E27 isoleringsindsats kl. 2.		
	E27D-PA66 PA66 hvid	1000 stk.	
	E27D PP natur	1000 stk.	

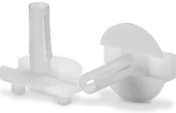
	SDIR27 aflastning f/rund ledning		
	ARD027103	1000 stk.	
	For E27 klik fatning kl. 2. Passer i metalrør indvendig Ø6,5/Ø6,8. Termoplast.		

	E27 isoleringsindsats kl. 2.		
	E27E-PA66 PA66 hvid	1000 stk.	

	E27 isoleringsindsats		
	967A0006 speciel Ø7	1000 stk.	
	Med Ø7 mm. midterhul til tykkere kabler eller kabler med tekstil. Termoplast.		

	E27 omløbsring Ø47 mm. TP		
	ARD011094 hvid	500 stk.	
	ARD011095 sort	500 stk.	
	ARD026476 hvidlakeret	500 stk.	
	Ø47x9 mm. Termoplast.		

	E27 omløbsring Ø57 mm. TP		
	ARD012607 hvid	500 stk.	
	ARD011091 sort	500 stk.	
	Ø57x12 mm. Termoplast.		

E27 fatninger 3-delt termoplast

	E27 indlæg TP	
	ARD040318	500 stk.
	Med skruesklemmer. T180, 4A, 250V, CE.	

	E27 kappe glat TP	
	ARD038233 hvid	500 stk.
	ARD038234 sort	500 stk.
	Ø38x37,5 mm. T190, 4A, 250V, CE.	
	Termoplast.	

	E27 indlæg m/indstik TP	
	ARD040317	500 stk.
	Med indstiksklemmer. T180, 4A, 250V, CE.	

	E27 kappe 1/1 gevind TP	
	ARD038236 hvid	500 stk.
	ARD038237 sort	500 stk.
	Ø40x37,5 mm. T190, 4A, 240V, CE.	
	Termoplast.	

	E27 bund M10 NIP TP	
	ARD028275 hvid	500 stk.
	ARD028276 sort	500 stk.
	Ø37,5x16,5 mm. T190, 4A, 250V, CE.	
	Termoplast.	

	E27 kappe 1/2 gevind TP	
	ARD040573 hvid	500 stk.
	ARD040572 sort	500 stk.
	Ø40/Ø48x37,5 mm. T190, 4A, 240V, CE.	
	Termoplast.	

	E27 bund M10 NIP TP m/jord	
	ARD028279 sort	500 stk.
	Ø37,5x16,5 mm. T190, 4A, 250V, CE.	
	Termoplast.	

	E27 omløbsring Ø47 mm. TP	
	ARD011094 hvid	500 stk.
	ARD011095 sort	500 stk.
	ARD026476 hvidlakeret	500 stk.
	Ø47x9 mm. Termoplast.	

	E27 bund M10 ASFV TP	
	ARD028269 hvid	500 stk.
	ARD028270 sort	500 stk.
	Ø37,5x16,5 mm. T190, 4A, 250V, CE.	
	Termoplast.	

	E27 omløbsring Ø57 mm. TP	
	ARD012607 hvid	500 stk.
	ARD011091 sort	500 stk.
	Ø57x12 mm. Termoplast.	

	E27 bund M10 ASFV m/sidehul TP	
	ARD026694 hvid	500 stk.
	Ø37,5x16,5 mm. T190, 4A, 250V, CE.	
	Med skrue. Termoplast.	

	SDI27 aflastning f/flad ledning	
	ARD024876	2000 stk.
	For E27 3-delte fatninger kl. 2. med indlæg ARD040318 eller ARD040317. Passer i metalrør Ø6,5/Ø6,8i. Termoplast.	

	E27 isoleringsindsats kl. 2.	
	E27D-PA66 PA66 hvid	1000 stk.
	E27D PP natur	1000 stk.

	E27 isoleringsindsats kl. 2.	
	E27E-PA66 PA66 hvid	1000 stk.

E27 fatninger 3-delt termoplast

	E27 indlæg m/trækafbryder	
	ARD033273 hvid snor	500 stk.
	ARD024647 konisk hvid knop	500 stk.
	ARD026427 konisk sort knop	500 stk.
2A, 250V, CE. Med skrueklemmer.		

	E27 indlæg m/vip-afbryder	
	ARD031808 hvid	500 stk.
	ARD031807 sort	500 stk.
	2A, 250V, CE. Med skrueklemmer.	

	E27 bund M10 f/trækafbryder TP	
	ARD033593 hvid	500 stk.
	ARD033275 sort	500 stk.
	Ø38x30 mm. 2A, 250V, CE. Termoplast.	

	E27 bund M10 f/vip-afbryder	
	ARD031798 hvid	500 stk.
	ARD031797 sort	500 stk.
	Ø37,8x37,7 mm. T190, 4A, 250V, CE. Termoplast.	

	E27 isoleringsindsats kl. 2.	
	E27D-PA66 PA66 hvid	1000 stk.
	E27D PP natur	1000 stk.

	E27 kappe glat TP	
	ARD038233 hvid	500 stk.
	ARD038234 sort	500 stk.
	Ø38x37,5 mm. T190, 4A, 250V, CE. Termoplast.	

	E27 isoleringsindsats kl. 2.	
	E27E-PA66 PA66 hvid	1000 stk.

	E27 kappe 1/1 gevind TP	
	ARD038236 hvid	500 stk.
	ARD038237 sort	500 stk.
	Ø40x37,5 mm. T190, 4A, 240V, CE. Termoplast.	

	E27 isoleringsindsats	
	967A0006 speciel Ø7	1000 stk.
	Med Ø7 mm. midterhul til tykkere kabler eller kabler med tekstil.	
	Termoplast.	

	E27 kappe 1/2 gevind TP	
	ARD040573 hvid	500 stk.
	ARD040572 sort	500 stk.
	Ø40/Ø48x37,5 mm. T190, 4A, 240V, CE. Termoplast.	





	E27G bund f/pendel TP	
	ARD018644 hvid	500 stk.
	ARD018645 sort	500 stk.
	Ø57x27,5 mm. T190, 4A, 250V, CE. Beregnet for aflast ARD017814. Termoplast.	

	E27 omløbsring Ø47 mm. TP	
	ARD011094 hvid	500 stk.
	ARD011095 sort	500 stk.
	ARD026476 hvidlakeret	500 stk.
Ø47x9 mm. Termoplast.		

	SCPN aflastning f/rund ledning	
	ARD017814	2000 stk.
	Beregnet for E14 og E27 bund. F/pendel TP. Termoplast.	

	E27 omløbsring Ø57 mm. TP	
	ARD012607 hvid	500 stk.
	ARD011091 sort	500 stk.
	Ø57x12 mm. Termoplast.	

E27 metalfatninger

	<p>E27 bund M10 metal</p> <p>ARD027063 messing 500 stk. ARD027064 hvid zink 500 stk. ARD035919 kobber 500 stk.</p> <p>Ø38x30 mm. 4A, 250V, T230, CE. Metal.</p>
	<p>E27 isolerdel f/metal</p> <p>ARD015026 sort 500 stk.</p> <p>Termoplast.</p>
	<p>E27 indlæg f/metal</p> <p>ARD033787 med jord 500 stk.</p> <p>4A, 230V, T230, CE. PPS.</p>
	<p>E27 kappe 1/1 gevind metal</p> <p>ARD033996 messing 500 stk. ARD033997 hvid zink 500 stk. ARD035918 kobber 500 stk.</p> <p>Ø40x34 mm. 4A, 230V, T230, CE. Metal.</p>
	<p>E27 omløbsring Ø60 metal</p> <p>ARD011489 messing 500 stk. ARD011841 hvid zink 500 stk. ARD035920 kobber 500 stk.</p> <p>Ø60x15,5 mm. Metal.</p>

E14, E27, E40, B22 porcelænsfatninger

	Fatning E14 Porcelæn	
	350B0107 M10	12 stk.
	Ø32,3x54 mm. 2A, 250V, T220. Porcelæn glaseret.	

	E27 fatning porcelænssockel	
	355P0107	200 stk.
	Ø43x46,5 mm. 4A, 250V, T250, CE. Porcelæn.	

	Fatning E27 Porcelæn	
	355A0107 M10	50 stk.
	Ø45x65 mm. 4A, 250V T250. Porcelæn glaseret.	

	E27 fatning porcelæn m/fjeder	
	355P0207	150 stk.
	Ø43x46,5 mm. 4A, 250V, T250, CE. Porcelæn.	

	Fatning E27 Porcelæn	
	355M0107 M10	50 stk.
	Ø46x61 mm. 4A, 250V T250. Porcelæn glaseret hvid.	

	E27 fatning porcelæn M10	
	355P0307	150 stk.
	Ø44x59 mm. 4A, 250V, T250, CE. Porcelæn.	

	Fatning E27 Porcelæn	
	355M0107 M10	50 stk.
	Ø46x61 mm. 4A, 250V T250. Porcelæn glaseret sort.	

	E27 fatning porcelæn m/jord m/bøjle	
	355P0407	200 stk.
	Ø43,5x46,5 mm. 4A, 250V, T250, CE. Porcelæn.	

	Fatning E27 Porcelæn	
	355H0107 M10	50 stk.
	355K0107 M10, med jord	50 stk.
	355C0107 M13, med jord	50 stk.
	355D0107 3/8"R, med jord	50 stk.
	Ø47x63 mm. 4A, 250V, T220, IP20. Porcelæn.	

	Fatning E40 Porcelæn	
	ARD036586	1 stk.
	Ø69x80 mm. 16A, 250V, T300. Ledningsklemmer 1,5-4 mm ² . Fastgøres med skruer M5.	

	Fatning E27 Illumination	
	355F0107	20 stk.
	Ø50x49 mm. 4A, 250V, T250. Porcelæn.	

	B22 fatning porcelænssockel	
	ARD018157	250 stk.
	Til klik bund eller fastgørelse med skruer. Ø38,5x40 mm, 4A, 250V, T220, CE. Porcelæn.	

G4, G9, GX53 fatninger

	G4 fatning	
	ARD023113	500 stk.
	Ledning: Sil. 0,75. Længde 12,5 cm. For Ø7,7-7,8 mm rør.	

	GX53 fatning	
	1858A0007	500 stk.
	Ledning: Flad H03VVH2-F 2x0,75 mm ² . 9,5 mm. høj. Ledning: Længde 14 cm. 2A, 250V, 110°C, CE.	

	Fatning	
	G4 GZ4 GX5,3 G6,35 GY6,35	
	ARD019940	500 stk.
	ARD019940	25 stk.
	Fastgøres med M3 skruer. Ledning: Sil. 0,75. Længde 12,5 cm. 4A, 24V, T180.	

	G9 fatning	
	ARD034447	500 stk.
	2A, 250V, T270, CE. Steatite.	

	G9 fatning m/bund M10	
	381A0106	25 stk.
	Består af: Fatning samt fatningsbund. 2A, 250V, T250.	

	G9 fatning med 1 m. ledning	
	ARD027974	500 stk.
	2A, 250V, T270, CE. Steatite.	

	G9 fatning	
	1855A0007	500 stk.
	Fastgøres med M3 skruer. Hulafstand 13 mm. 0,5-1,0 mm ² . 23,3 mm. høj. 2A, 250V, T250, CE. Steatite.	

	G9 fatningshus M10	
	ARD027806 uden isolator	500 stk.
	ARD028389 med isolator	500 stk.
	Med metal klips. Passer til G9 fatning ARD034447 og ARD027974. 2A, 250V, CE.	

	G9 fatning	
	1857G0107	25 stk.
	Fastgøres med M3 skruer. Ø18,2x24,6 mm. 2A, 250V, T250.	

	Omløbsring f/G9 fatning	
	316N0007	500 stk.
	Termoplast. Ø28 mm, højde 7,5 mm. T270, CE.	

	Omløbsring f/G9 fatning	
	ARD026634	500 stk.
	Metal. Ø27 mm, højde 7 mm. CE.	

GU10, GZ10, B15, B22 fatninger

	GU10 fatning f/påskruning	
	ARD019931	500 stk.
	ARD019931	25 stk.
Fastgøres med M3 skruer. Ledning: FPFP20. Længde 25 cm. KI.2., 4A, 250V, T250.		

	GZ10 fatning f/påskruning	
	ARD019935	500 stk.
	Fastgøres med M3 skruer. Ledning: FPFP20. Længde 25 cm. KI.2., 4A, 250V, T250.	

	GU10 fatning f/påskruning	
	ARD019501	500 stk.
	ARD019501	25 stk.
Fastgøres med M3 skruer. Ledning: TF20. Længde 25 cm. 4A, 250V, T250.		

	B15 fatning M10 2-pol.	
	360A0136 messing	10 stk.
	Ø25x38 mm. 2A, 250V, CE.	

	GU10 fatning f/påskruning	
	1856A0007	500 stk.
	Fastgøres med M3 skruer. Med indstiksklemmer. 2A, 250V, T250. Bund med M10x1 gevind kan monteres.	

	B22 fatning M10 2-pol.	
	365A0136 messing	10 stk.
	Ø33x41 mm. 2A, 250V, CE.	

	GU10 bund med M10x1 gevind	
	1856B0008	500 stk.
	Fastgøres med medfølgende skruer. Termoplast.	

G13, 2G11 fatninger

	G13 fatning f/indstik	100 stk.
	375D0107 Højde lampeakse = 30 mm. PC, T130.	

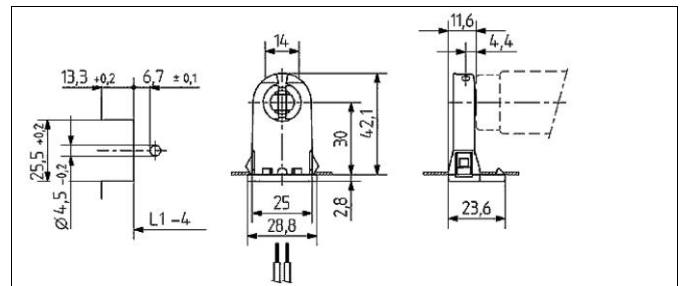

	G13 fatning f/indstik Med glimttænderholder.	100 stk.
	375E0107 Højde lampeakse = 30 mm. PC, T130.	

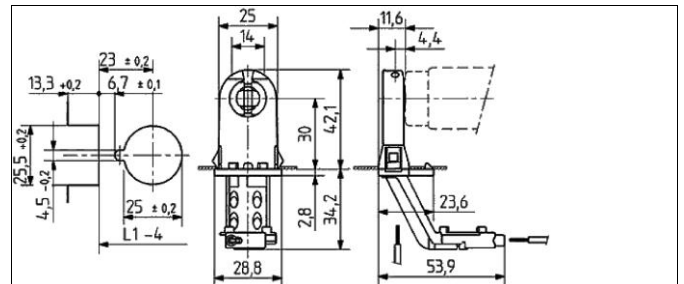

	G13 fatning f/påklips	100 stk.
	375F0107 Fatningstykkelse A = 13 mm. PC, T130.	

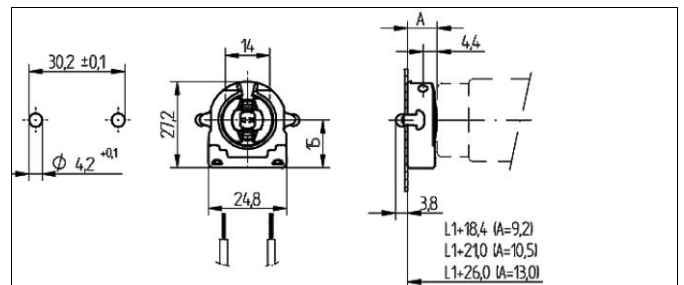

	G13 fatning f/påklips m/fjeder	100 stk.
	375L0107 Fatningstykkelse A = 13 mm. PC, T130.	

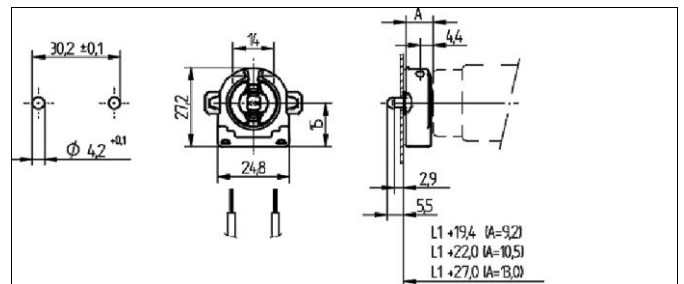

	G13 fatning f/påklips Med glimttænderholder.	100 stk.
	375G0107 Fatningstykkelse A = 13 mm. PC, T130.	

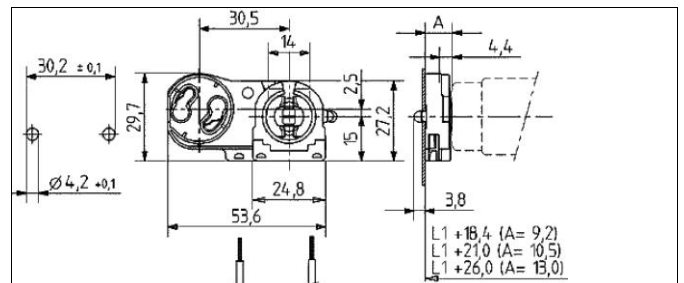

	Fatning 2G11	25 stk.
	380A0107 PC, T130.	

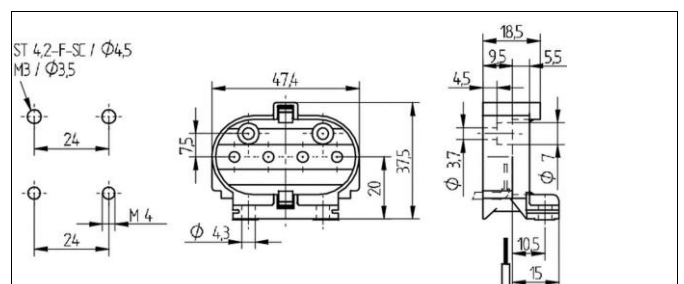

G13, T5 fatninger

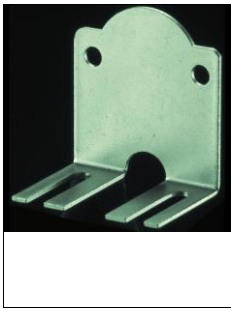

G13 fatningsholder f/påklips
 375H0129 100 stk.
 Højde lampeakse = 25 mm.
 Stål el-galv.

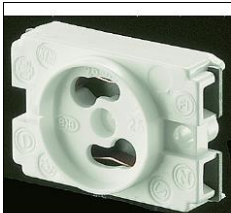
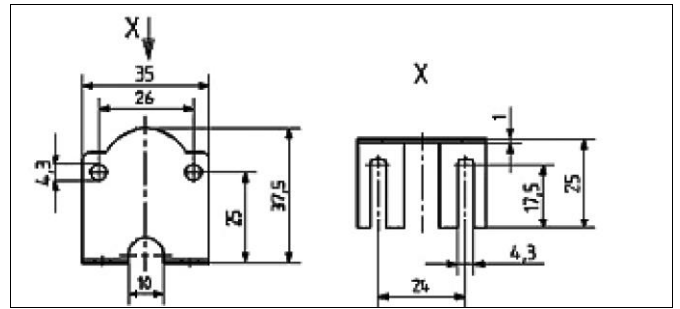

G13 Starterholder f/påskrugning
 375K0107 100 stk.
 PC, T130.

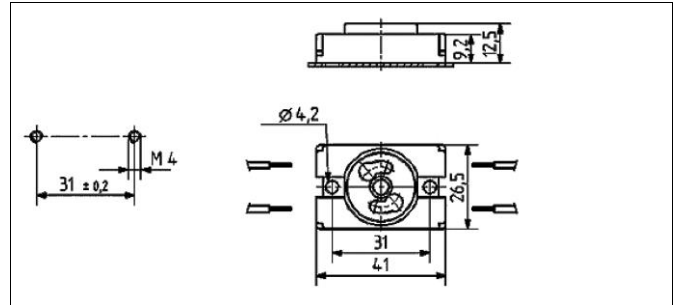

T5 fatning f/indstik
 376A0107 100 stk.
 Højde lampeakse = 15,8 mm.
 PC, T130.

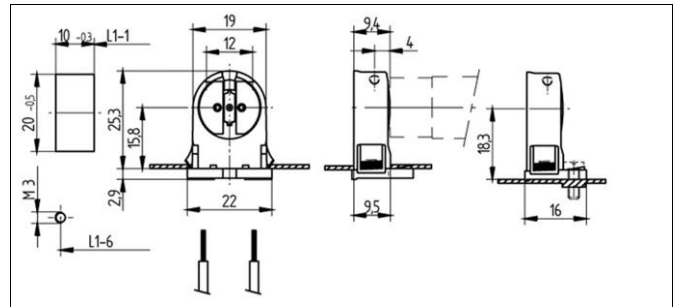

T5 fatning f/påklips m/fjeder
 376B0107 100 stk.
 Fatningstykkelse = 9,4 mm.
 PC, T130.

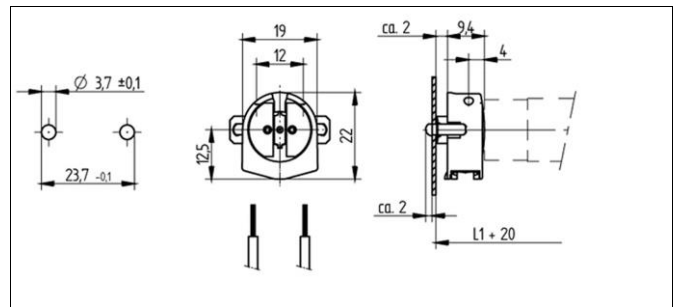

Fatningsadptore

	Fatningsadapter E27-E14 110D0007 hvid 25 stk.
	Fatningsadapter som gør det muligt at montere en E14 pære i en E27 fatning. Adapter længde 45 mm. 2A, 250V, T210. Materiale steatite.

	Fatningsadapter E27-GU10 110F0007 hvid 25 stk.
	Fatningsadapter som gør det muligt at montere en GU10 pære i en E27 fatning. Adapter længde 46 mm. 2A, 250V, T210. Materiale steatite.

	Fatningsadapter E14-GU10 110H0007 hvid 25 stk.
	Fatningsadapter som gør det muligt at montere en GU10 pære i en E14 fatning. Adapter længde 48 mm. 2A, 250V, T210. Materiale steatite.

	Fatningsadapter E27-G9 110K0007 hvid 25 stk.
	Fatningsadapter som gør det muligt at montere en G9 pære i en E27 fatning. Adapter længde 46 mm. 2A, 250V, T210. Materiale steatite.

	Fatningsadapter E14-G9 110G0007 hvid 25 stk.
	Fatningsadapter som gør det muligt at montere en G9 pære i en E14 fatning. Adapter længde 49 mm. 2A, 250V, T210. Materiale steatite.

	Fatningsadapter E40-E27 110E0007 hvid 25 stk.
	60 Watt, 230 Volt. Metal og plast.

Forgreningsmateriel

	<p>Klemrække 2-polet</p> <p>134/2 2,5 mm². 1000 stk. 135/2 4,0 mm². 1000 stk.</p> <p>400V, CE. Messing, skruer M3 jern. Polyamid natur.</p>		<p>Samlemuffe skrueløs 1-polet</p> <p>140-2 2x0,2-4mm². 1000 stk.</p> <p>450V, 32A, VDE. PC / PA66.</p>
	<p>Klemrække 3-polet</p> <p>134/3 2,5 mm². 1000 stk.</p> <p>400V, CE. Messing, skruer M3 jern. Polyamid natur.</p>		<p>Samlemuffe skrueløs 1-polet</p> <p>140-3 3x0,2-4mm². 1000 stk.</p> <p>450V, 32A, VDE. PC / PA66.</p>
	<p>Klemrække 12-polet</p> <p>134/12 2,5 mm². 1000 stk. 135/12 4,0 mm². 1000 stk.</p> <p>400V, CE. Messing, skruer M3 jern. Polyamid natur.</p>		<p>Samlemuffe skrueløs 1-polet</p> <p>140-5 5x0,2-4mm². 1000 stk.</p> <p>450V, 32A, VDE. PC / PA66.</p>
	<p>Trykmuffe 3-polet</p> <p>138A/3 med J-ben 1000 stk. 138B/3 uden J-ben 1000 stk.</p> <p>400V, 24A, 0,75-2,5mm², CE. Polyamid. Med jordblik.</p>		<p>Trykmuffe 5-polet</p> <p>138C/5 1000 stk.</p> <p>400V, 24A, 0,75-2,5mm², CE. Polyamid. Med jordblik.</p>
	<p>Samlemuffe 1-polet</p> <p>133/1 2,5 mm². 1000 stk.</p> <p>380V, CE.</p> <p>Messing, skruer M3 jern. Polycarbonat transparent.</p>		
	<p>2 kablers konnekter</p> <p>101T0006 500 stk.</p> <p>Til splejsning af kabler uden at fjerne isoleringen. Max. diameter på isolering Ø2,06 mm. Ledere fra 0,4 til 0,9 mm. Materiale: Gel-fyldt hus i Polypropylene med god miljøbeskyttelse også i våde og fugtige miljøer. Andre typer kan skaffes (gel-fyldte, ikke gel-fyldte, med farvekode mv.).</p>		<p>3 kablers konnekter</p> <p>101U0006 250 stk.</p> <p>Til splejsning af kabler uden at fjerne isoleringen. Max. diameter på isolering Ø2,08 mm. Ledere fra 0,4 til 0,9 mm. Materiale: Gel-fyldt hus i Polypropylene med fremragende miljøbeskyttelse også i våde og fugtige miljøer. Andre typer kan skaffes (gel-fyldte, ikke gel-fyldte, med farvekode mv.).</p>

Forgreningsmateriel

	Koblingsboks He 251	1000 stk.
	290107 hvid	
	2x0,75 - 1,5 mm ² .	
	250V, 6A, CE. 15,5x18,8x37,2 mm.	
	Messing, skruer M3 jern. Polyamid T110.	

	Koblingsboks TBI 124	250 stk.
	292007 hvid	
	2/3x1,5 - 2,5 mm ² .	
	14x27x43 mm.	
	Messing, skruer M3 jern. Polyamid T110.	

	Koblingsboks TBI 125	250 stk.
	292107 hvid	
	1x0,75 - 2,5 mm ² , hul Ø11 mm.	
	13x27x43 mm.	
	Messing, skruer M3 jern. Polyamid T110.	

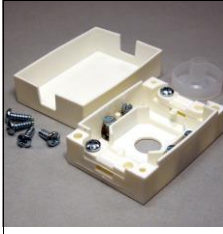
	Koblingsboks He 252-R	250 stk.
	290207 hvid	
	2x1,5 - 2,5 mm ² , kl. 2, hul Ø10 mm.	
	250-400V, 10 A, CE. 15x36x52 mm.	
	Messing, skruer M3 jern. Polyamid T110.	

	Koblingsboks He 253	250 stk.
	290407 hvid	
	2/3x1,5 - 2,5 mm ² .	
	250-400V, 10A, CE. 16,7x33x49 mm.	
	Messing, skruer M3 jern. Polyamid T110.	

	Samlebox for havelampe	1000 stk.
	92508 sort	
	Med bagplade og holder til Ø16 mm. rør.	
	Uden skruer.	
	18x71x35 mm. ABS.	

	Koblingsboks He 254	250 stk.
	290007 hvid	
	4x0,75 - 1,5 mm ² , kl. 2.	
	250V, 10A, CE. 14,1x33,9x51,6 mm.	
	Messing, skruer M3 jern. Polyamid T110.	

Forgreningsmateriel

	Multibox u/klemrække 110A0105 grå 1 stk. Forsynet med 16 stk. udslagsblanketter for kabel eller rør. Ø16 eller Ø22 mm. IP20 180x120x40 mm. CE. ABS.
---	--

Multibox Multiboxen er den ideelle løsning, hvor der er behov for et stort antal tilgange eller afgreninger på et sted. Giver en overskuelig installation og samler installationen i let tilgængelige knudepunkter.

	Klemrække - 16+2 klemmer 110A1007 1 stk. 16 stk. kroneklemmer + 2 stk. 3-dobbelte klemmer a 4 mm ² . CE.
---	---

Klemrækker som tilbehør til multiboxen Klemrækker med mange afgreningsmuligheder gør det let at udvide installationen. Multiboxen kan forsynes med 1 eller 2 stk. klemrækker efter behov.

	Klemrække - 7+5 klemmer 110B1007 1 stk. 7 stk. kroneklemmer + 5 stk. 3-dobbelte klemmer a 4 mm ² . CE.
--	---

Forskrugninger

	<p>Ventilations plug 439A1208 sort 250 stk. M12x1,5. Air flow 300 L/H. Højde 15 mm. Gevindlængde 6 mm. Med O-ring. PA6.</p>
---	--

	<p>Kabelforskrugning 441B0008 sort 250 stk. M16x1,5. For kabel Ø4-8 mm. Højde 28 mm. Gevindlængde 8 mm. Med O-ring og møtrik. PA6.</p>
--	---

	<p>Ventil forskrugning 438A1608 sort 250 stk. M16x1,5. Air flow 70 L/H. Højde 34 mm. Gevindlængde 10 mm. Med O-ring. PA6.</p>
---	--

	<p>Kabelforskrugning 441C0008 sort 250 stk. M16x1,5. For kabel Ø5-10 mm. Højde 29 mm. Gevindlængde 10 mm. Med O-ring og møtrik. PA6.</p>
--	---



Glas

	Kugleglas Ø150/84,5 mm. 726A0042 opal 12 stk. Glas med Ø84,5 mm. gevind.
---	---

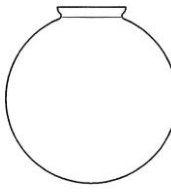
	Kugleglas Ø250/100 mm. krave 726E0142 opal 1 stk. 726E0143 klar 1 stk. Glas. 726C0600 spændering af gummi.
--	---

	Staldglas L160/84,5 mm. 726B0042 opal 12 stk. 726B0043 klar 12 stk. 726B0044 sandblæst 12 stk. 1,5 cm klart glas ved krave. Glas med Ø84,5 mm. gevind.
---	--

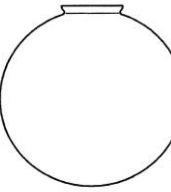
	Kugleglas Ø300/100 mm. krave 726C0142 opal 1 stk. 726C0143 klar 1 stk. Glas. 726C0600 spændering af gummi.
--	---

	Staldglas i plast L160/84,5 mm. 727A0043 klar 20 stk. Plast (PC) med Ø84,5 mm. gevind.
--	---

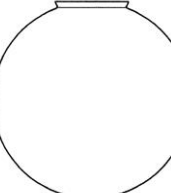
	Kugleglas Ø450/150 mm. krave 726D0143 klar 1 stk. Glas. 726D0007 spændering af aluminium.
---	---

	Pakning f/glas m/84,5 gevind 726B6008 sort 10 stk. Ø94/Ø80x2 mm. Gummi.
---	---

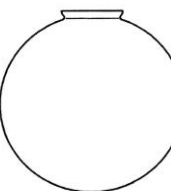
	Kuppel PC Ø300/100 mm. krave 727B0142 opal 1 stk. 727B0143 klar 1 stk. Polycarbonat. 726C0600 spændering af gummi.
--	---

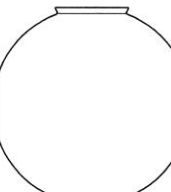
	Kuppel PC Ø450/150 mm. krave 727C0142 opal 1 stk. 727C0143 klar 1 stk. Polycarbonat. 726D0600 spændering af gummi.
--	---

Halogensæt

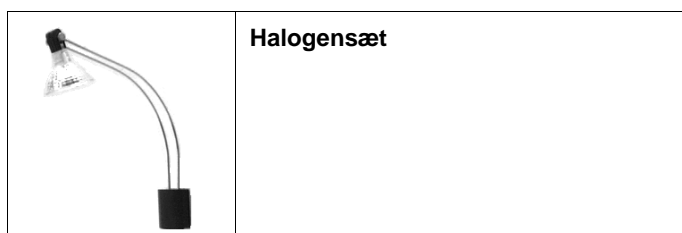

Halogensæt

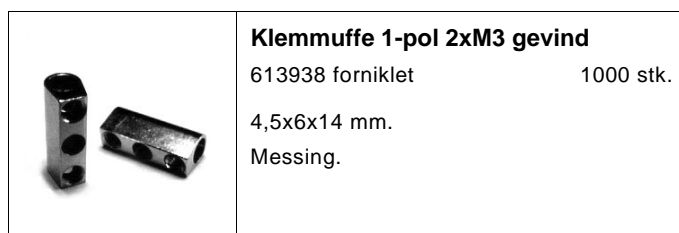

Klemmuffe 1-pol 2xM3 gevind

613938 forniklet 1000 stk.
4,5x6x14 mm.
Messing.

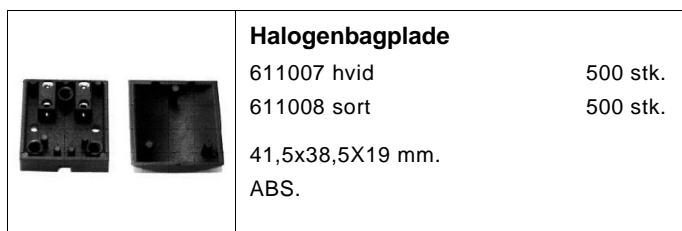

Halogenbagplade

611007 hvid 500 stk.
611008 sort 500 stk.
41,5x38,5x19 mm.
ABS.

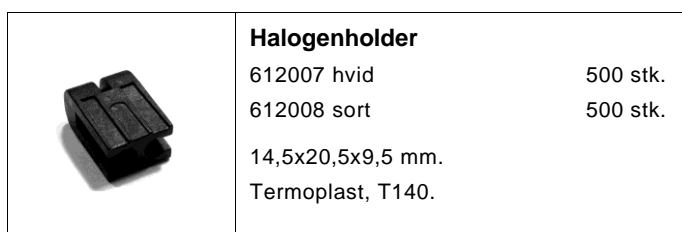

Halogenholder

612007 hvid 500 stk.
612008 sort 500 stk.
14,5x20,5x9,5 mm.
Termoplast, T140.

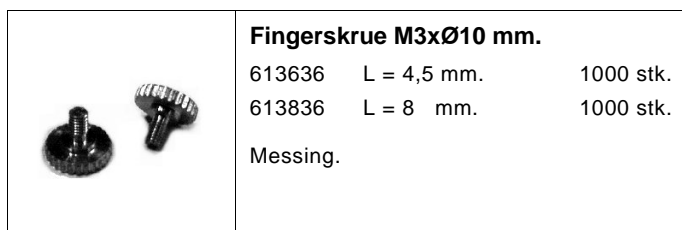

Fingerskrue M3xØ10 mm.

613636 L = 4,5 mm. 1000 stk.
613836 L = 8 mm. 1000 stk.
Messing.

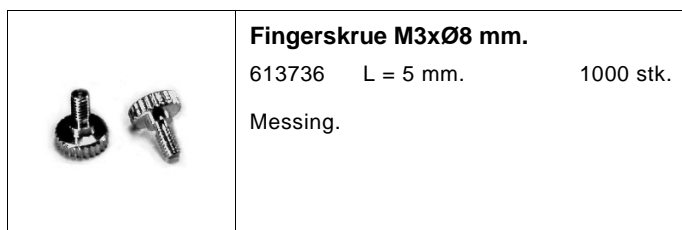

Fingerskrue M3xØ8 mm.

613736 L = 5 mm. 1000 stk.
Messing.

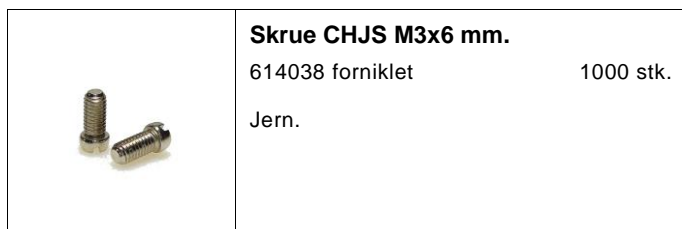

Skrue CHJS M3x6 mm.

614038 forniklet 1000 stk.
Jern.

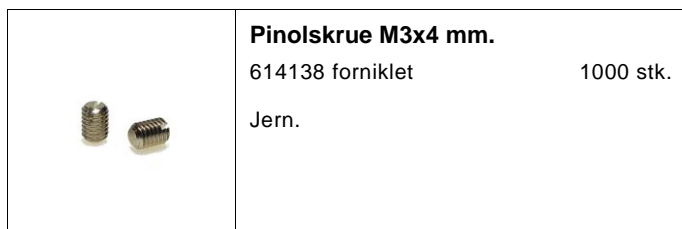

Pinolskrue M3x4 mm.

614138 forniklet 1000 stk.
Jern.

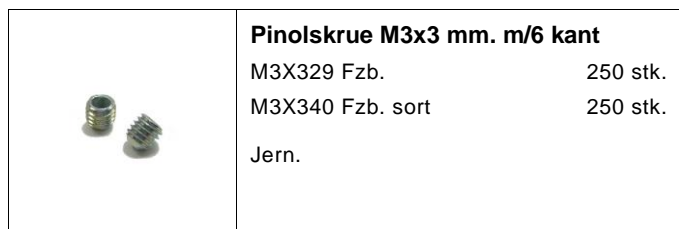

Pinolskrue M3x3 mm. m/6 kant

M3X329 Fzb. 250 stk.
M3X340 Fzb. sort 250 stk.
Jern.

Hangtag og hætter

	Hangtag SDS PLUS	
	704A0040	1000 stk.
Hangtag for hammorbor. SDS plus. 40x78 mm. Termoplast.		



	Hangtag SDS PLUS STOR	
	704B0040	1000 stk.
Hangtag for hammorbor. SDS plus stor. 40x78 mm. Termoplast.		





	Hætte top m/krog i 6 størrelser
	Type 1: Ø13,2 mm - højde 8,8 mm. Type 2: Ø18,5 mm - højde 11,2 mm. Type 3: Ø23,5 mm - højde 14,5 mm. Type 3,5: Ø28,0 mm - højde 16,6 mm. Type 4: Ø35,0 mm - højde 16,7 mm. Type 5: Ø42,7 mm - højde 20,3 mm.
Termoplast.	

	Hætte bund i 7 størrelser
	Type 1: Ø13,2 mm - højde 8,8 mm. Type 2: Ø18,5 mm - højde 11,2 mm. Type 3: Ø23,5 mm - højde 14,5 mm. Type 3,5: Ø28,0 mm - højde 16,6 mm. Type 4: Ø35,0 mm - højde 16,7 mm. Type 5: Ø42,7 mm - højde 20,3 mm. Type 6: Ø57,6 mm - højde 25,0 mm.
Termoplast.	

Jordblik





	Jordblik med skrue		
	163217	M/Ø 10,5 hul	1000 stk.
	163517	M/Ø 13,5 hul	1000 stk.
	El-galv.		

	Jordblik med skrue		
	163218	M/Ø 10,5 hul	1000 stk.
	El-galv.		

	Jordblik med skrue		
	163220	M/Ø 3,2 hul	1000 stk.
	El-galv.		

	Jordblik		
	1810A163419	M/Ø 10,5 hul	1000 stk.
	El-galv.		

Kipled

	<p>Kipled 017D00038 forkromet 25 stk.</p> <p>Vippefunktion 180 grader. Drejefunktion 360 grader. M10x1 indv. M10x1 udv. Ø16 x 42 mm. Med reces og M3 gevind.</p>		<p>Kugleled 017B0136 messing 25 stk.</p> <p>Vippefunktion 50 grader. Drejefunktion 340 grader. M10 indv. med låseskrue. M10 udv. Ø16 x 27 mm.</p>
	<p>Kipled 017E0036 messing 25 stk. 017E0038 forkromet 25 stk.</p> <p>Vippefunktion 90 grader. Drejefunktion 360 grader. M10x1 indv. M10x1 udv. Ø16 x 36 mm. Med reces og M3 gevind.</p>		<p>Kipled 017C0036 messing 25 stk. 017C0038 forkromet 25 stk.</p> <p>Vippefunktion 90 grader. Drejefunktion 360 grader. M10x1 indv. M8x1 udv. Ø13 x 35,5 mm.</p>
	<p>Kipled 017F0036 messing 25 stk. 017F0038 forkromet 25 stk.</p> <p>Vippefunktion 90 grader. Drejefunktion 360 grader. M10x1 indv. M10x1 udv. Ø16 x 46 mm.</p>		

Kugler: Kugler

	Kugle Ø10 mm. 100336 messing 250 stk. M3 sækgevind.
---	--

	Kugle Ø20 mm. 204036 messing 100 stk. M10x1 gennemgående gevind.
--	---

	Kugle Ø14 mm. 140636 messing 250 stk. M6x1 sækgevind.
---	--

	Kugle Ø20 mm. 203036 messing 100 stk. 3xM10x1 gevind. T-Form.
--	---

	Kugle Ø14 mm. 141136 messing 250 stk. 141119 forniklet 250 stk. M10x1 sækgevind.
---	--

	Kugle Ø30 mm. 301036 messing 50 stk. M10x1 sækgevind. 304036 messing 50 stk. M10x1 gennemgående gevind.
--	--

	Kugle Ø14 mm. flad 141036 messing 250 stk. M10x1 sækgevind. Ø14 mm., 8,3 mm. flad.
---	--

	Kugle (ring) Ø14 mm. 141236 messing 250 stk. M10x1 gennemgående gevind. Ø14 mm., 8 mm. høj.
---	---

	Kugle Ø20 mm. 201036 messing 100 stk. M10x1 sækgevind.
---	---

	Kugle Ø20 mm. 202036 messing 100 stk. 2xM10x1 vinkelgevind.
---	--

Kugler: Bundknapper

	Bundknapp 155736 messing 250 stk. M10x1 indvendig gevind. Ø16 mm., 18 mm. høj.
---	--

	Slangehoved 171236 messing 100 stk. Drejet for 2 fleksible slangearme. M10x1. Nederst M13x1 indv. gevind.
--	--

	Bundknapp 100036 messing 200 stk. M10x1 indvendig gevind. Ø16 mm., 20 mm. høj.
---	--

	Slangehoved 171336 messing 100 stk. Drejet for 3 fleksible slange-arme. M10x1. Nederst M13x1 indv. gevind.
--	---

	Bundknapp 118036 messing 250 stk. M10x1 indvendig gevind. Ø16 mm., 21 mm. høj.
---	--

	Bundknapp 112036 messing 250 stk. M10x1 indvendig gevind. Ø12 mm., 12 mm. høj.
--	--

	Bundknapp 150536 messing 250 stk. M10x1 indvendig gevind. Ø14 mm., 24 mm. høj.
---	--

	Bundknapp 112219 forniklet 250 stk. 112236 messing 250 stk. M10x1 indvendig gevind. Ø14 mm., 8,5 mm. høj.
--	--

	Bundknapp 103036 messing 50 stk. M10x1 indvendig gevind. Ø24 mm., 30 mm. høj.
---	---

	Hals 040236 messing 100 stk. Ø16mm., 39 mm. høj. Ø10,5 mm hul.
---	--

Ledningsholdere

	Ledningsholder for rør	
	70106 transp.	1000 stk.
	70108 sort	1000 stk.
	Til Ø13 mm. rør.	
	70208 sort	1000 stk.
	Til Ø16 mm. rør.	
	Termoplast.	



	Ledningsholder for wire Ø1,2 mm.	
	70506 natur	1000 stk.
	For Ø1,2 mm wire. For ledning med diameter Ø5,3-6,4mm. Termoplast.	

	Ledningsholder	
	465C0006 natur	1000 stk.
	For brug i lysstofarmaturer.	
	Pladetykkelse 0,75-1,5 mm.	
	Hul i plade: Ø4,5-5,0 mm. Polyacetal.	

	Ledningsholder for wire	
	465A0006 transp. Ø6,5x2,0	1000 stk.
	465B0006 transp. Ø3,5x1,8	1000 stk.
	465D0006 transp. Ø5,0x2,0	1000 stk.

	Kabelholder	
	1705A64206 natur	1000 stk.
	For Ø6 ledning.	

Ledningssæt

	Ledningssæt m/EU- stik	
	2,0 m.	
	ARD002634 hvid	250 stk.
	ARD002635 sort	250 stk.
	ARD019762 transp.	100 stk.
	3,0 m.	
	ARD010241 hvid	150 stk.
	ARD002645 sort	150 stk.
	3,5 m.	
	ARD020834 transp.	100 stk.
	4,0 m.	
	ARD007851 hvid	150 stk.
	ARD013415 sort	150 stk.
		Ledningssæt m/EU- stik og tekstil
4,0 m.		
422A4007 hvid		100 stk.
422A4008 sort		100 stk.
Flad ledning 2x0,75 mm ² .		
2,5A, 250V. Hylse på ledningsender. H03VVH2-F.		

	Lamprop kl. 1.	
	340007 hvid	500 stk.
	3G0,75 mm ² .	
	Rund ledning 0,15 m.	

	Lamprop kl. 2.	
	340107 hvid	500 stk.
	2x0,75 mm ² .	
	Rund ledning 0,15 m.	

	Spiralledning 1,8 m		
	410X1807 hvid	2x0,75 mm ²	1 stk.
	410X1808 sort	2x0,75 mm ²	1 stk.
	410Y1807 hvid	3G0,75 mm ²	1 stk.
	410Y1808 sort	3G0,75 mm ²	1 stk.
	70 grader.		

	Ledningssæt m/afbryder +EU-stik	
	1,5 + 0,5 m.	
	ARD020241 hvid	250 stk.
	ARD020564 sort	250 stk.
	1,5 + 0,7 m.	
	ARD026100 hvid	250 stk.
	ARD026924 sort	250 stk.
	ARD030367 transp.	100 stk.
	1,5 + 1,0 m.	
	ARD025235 hvid	200 stk.
	ARD025867 sort	200 stk.
	ARD022639 transp.	100 stk.
	1-polet afbryder.	
	Flad ledning 2x0,75 mm ² .	
2A, 250V. Hylse på ledningsender. H03VVH2-F.		

	Schuko	
	2,0 m.	
	ARD014001 sort	150 stk.
	2,5 m.	
	ARD014050 sort	150 stk.
	3,0 m.	
	ARD014931 sort	100 stk.
	Rund ledning 3G0,75 mm ² .	
16A, 250V. Hylse på ledningsender. H03VV-F.		

	Terminalrør	
	1508A0018 0,75 mm ²	1000 stk.
	1508C0518 0,50 mm ²	1000 stk.
	6 mm. lang.	

Ledning 70 grader

	Ledning 2x0,75 mm² T70	
	410D0006 transp.	200 m.
	PVC T70, PVC T70. Rund Ø5,4 ± 0,2 mm. 03VV-F.	

	Ledning 2x0,75 mm² T70	
	410P0006 transp.	300 m.
	PVC T70, PVC T70. Flad 3,3x5,5 ± 0,1 mm. 03VVH2-F.	

	Ledningssæt 2x0,75 mm² T70	
	410D2506 2,5 m. transp.	25 stk.
	410D4006 4,0 m. transp.	25 stk.
	M/hylse i én ende. PVC T70, PVC T70. Rund. Ø5,4 ± 0,2 mm. 03VV-F.	

	Ledning 2x0,75 mm² T70	
	410P0012 guld.	200 m.
	PVC T70, PVC T70. Flad 3,2x5,1 ± 0,2 mm. H03VVH2-F.	

	Ledning 2x0,75 mm² T70	
	410E0007 hvid	100 m.
	410E0008 sort	100 m.
	410D2007 2,0 m. hvid	25 stk.
	410D2008 2,0 m. sort	25 stk.
	410E5007 5,0 m. hvid	25 stk.
	Ledning 3G0,75 mm² T70	
	410S0007 hvid	100 m.
	PVC T70, PVC T70. Rund Ø5,4 ± 0,2 mm. VDE H03VV-F.	

Ledning 180 grader

	Ledning 2x0,75 mm² T180	
	410C0106 transp.	300 m.
	FEP T180, PVC T70.	
	Rund Ø5,0 ± 0,2 mm. VDE 7727.	

	Ledning 2x0,75 mm² T180	
	405A0007 hvid	100 m.
	405A0008 sort	100 m.
	Silikone T180, Silikone T180. Rund Ø6,6 ± 0,2 mm. H05SS-F.	

	Ledningssæt 2x0,75 mm² T180	
	410C2506 2,5 m. transp.	25 stk.
	410C3006 3,0 m. transp.	25 stk.
	410C4006 4,0 m. transp.	25 stk.
FEP T180, PVC T70.		
Rund Ø5,0 ± 0,2 mm. VDE 7727.		

	Ledning 2x1,0 mm² T180	
	406A0008 sort	200 m.
	Silikone T180, Silikone T180. Rund Ø7,1 ± 0,2 mm. H05SS-F.	

	Ledning 2x0,75 mm² T180	
	410Q0006 transp.	300 m.
	FEP T180, PVC T70.	
	Flad 3,2x5,5 ± 0,2 mm.	

	Ledning 3G0,75 mm² T180	
	407A0008 sort	200 m.
	Silikone T180, Silikone T180. Rund Ø7,0 ± 0,2 mm. H05SS-FG.	

	Ledning 2x1,0 mm² T180	
	410N0006 transp.	300 m.
	FEP T180, PVC T70	
	Rund Ø5,2 ± 0,2 mm. VDE 7727.	

	Ledning 3G1,0 mm² T180	
	408A0008 sort	200 m.
	Silikone T180, Silikone T180. Rund Ø7,2 ± 0,2 mm. H05SS-FG.	

	Ledning 3x0,75 mm² T180	
	410L0006 transp.	300 m.
	FEP T180, PVC T70	
	Rund Ø5,3 ± 0,2 mm. VDE 7727.	

	Ledning 1x0,75 mm² T180	
	408A0006 transp.	100 m.
	FEP T180.	
	Rund Ø1,68 ± 0,1 mm.	

Ledning med tekstil rund 1

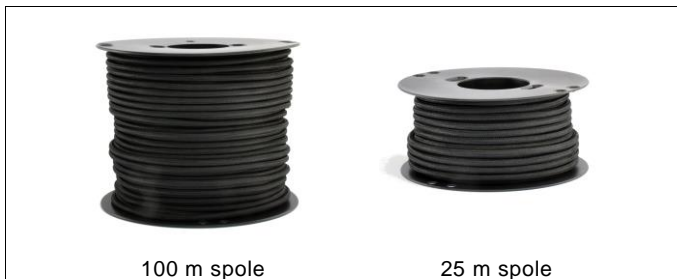



Rund tekstilledning

Rund 2x0,75 mm² Ø5,8 ± 0,2 mm.
 Rund 3G0,75 mm² Ø6,2 ± 0,2 mm.

H03VV-F. PVC T70, PVC T70.

Andre farver kan produceres efter ønske.

Tekstilledning brun			
	418A0001	2x0,75	100 m.
	418A2501	2x0,75	25 m.
	418C2501	3G0,75	25 m.

Tekstilledning hvid			
	418A0007	2x0,75	100 m.
	418A2507	2x0,75	25 m.
	418C2507	3G0,75	25 m.

Tekstilledning grøn			
	418A2502	2x0,75	25 m.

Tekstilledning sort			
	418A0008	2x0,75	100 m.
	418A2508	2x0,75	25 m.
	418C0008	3G0,75	100 m.
	418C2508	3G0,75	25 m.

Tekstilledning gul			
	418A2503	2x0,75	25 m.

Tekstilledning rød			
	418A0009	2x0,75	100 m.
	418A2509	2x0,75	25 m.

Tekstilledning orange			
	418A0004	2x0,75	100 m.
	418A2504	2x0,75	25 m.

Ledning med tekstil rund 2

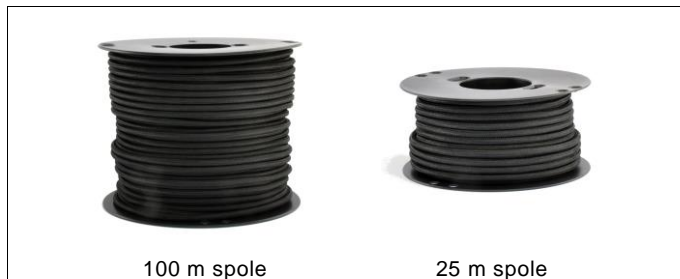

Rund tekstilledning

Rund 2x0,75 mm² Ø5,8 ± 0,2 mm.

Rund 3G0,75 mm² Ø6,2 ± 0,2 mm.

H03VV-F. PVC T70, PVC T70.

Andre farver kan produceres efter ønske.

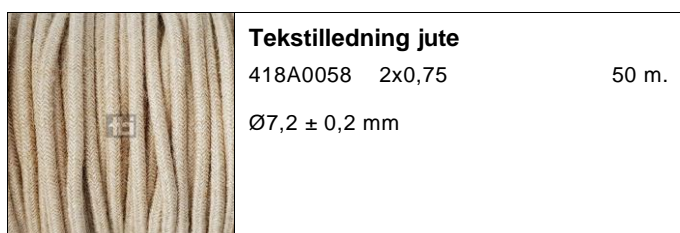
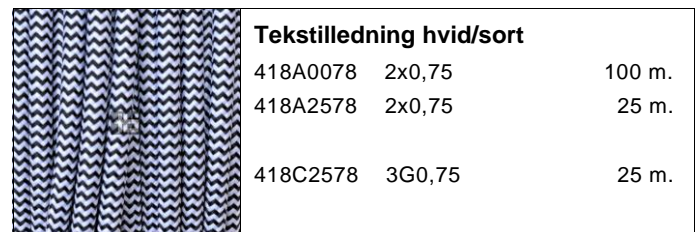
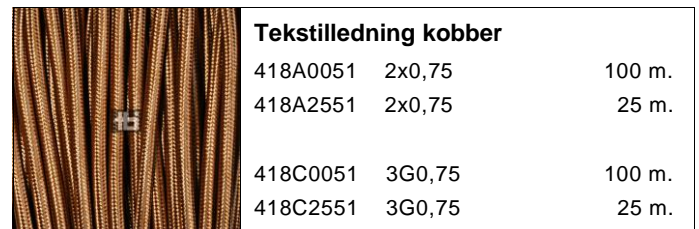
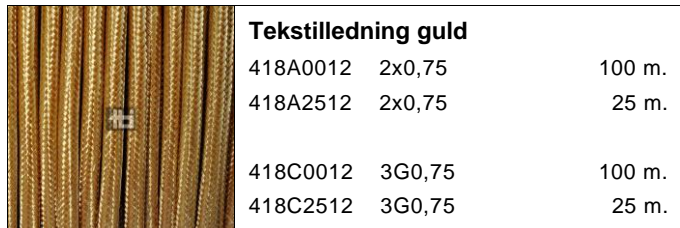

Ledning med tekstil snoet



Snoet tekstilledning

Snoet 2x0,75 mm² Ø5,8 ± 0,2 mm.

Snoet 3G0,75 mm² Ø6,2 ± 0,2 mm.

H05V-K. PVC T70, PVC T70.

Andre farver kan produceres efter ønske.

	Snoet tekstilledning brun		
	420A0001	2x0,75	100 m.
	420A2501	2x0,75	25 m.
	420B2501	3G0,75	25 m.

	Snoet tekstilledning guld		
	420A0012	2x0,75	100 m.
	420A2512	2x0,75	25 m.
	420B0012	3G0,75	100 m.
420B2512	3G0,75	25 m.	

	Snoet tekstilledning hvid		
	420A0007	2x0,75	100 m.
	420A2507	2x0,75	25 m.
	420B0007	3G0,75	100 m.
420B2507	3G0,75	25 m.	

	Snoet tekstilledning sølv		
	420A0013	2x0,75	100 m.
	420B0013	3G0,75	100 m.

	Snoet tekstilledning sort		
	420A0008	2x0,75	100 m.
	420A2508	2x0,75	25 m.
	420B0008	3G0,75	100 m.
420B2508	3G0,75	25 m.	

	Snoet tekstilledning kobber		
	420A0051	2x0,75	100 m.
	420A2551	2x0,75	25 m.
	420B0051	3G0,75	100 m.
420B2551	3G0,75	25 m.	

Ledning med tekstil

	Tekstilledning 2x0,75 mm² T180	
	411A0007 hvid	200 m.
	411A0008 sort	200 m.
	411A0009 rød	200 m.
	FEP T180, PVC T70. Rund Ø5,3 ± 0,2 mm. VDE 7727.	

	Ledningssæt 2x0,75 mm² T70		
	418B3005	3 m. grå	50 stk.
	PVC T70, PVC T70. Rund Ø5,8 ± 0,2 mm. Hylse på ledningsender. H03VV-F.		

	Tekstilledning 2x0,75 mm² T180	
	405B0007 hvid	200 m.
	405B0008 sort	200 m.
	Silikone T180, Silikone T180. Rund Ø6,8 ± 0,2 mm. H05SST-F.	

	Ledningssæt 2x0,75 mm² T70		
	418B3007	3 m. hvid	50 stk.
	418B3008	3 m. sort	50 stk.
	PVC T70, PVC T70. Rund Ø5,8 ± 0,2 mm. Hylse på ledningsender . H03VV-F.		

	Tekstilledning 3x0,75 mm² T180	
	405C0007 hvid	100 m.
	405C0008 sort	100 m.
	Silikone T180, Silikone T180. Rund Ø7,1 ± 0,1 mm. H05SST-F G.	

	Ledningssæt 2x0,75 mm² T180		
	405B5005	5 m. grå	50 stk.
	Silikone T180, Silikone T180. Rund Ø6,8 ± 0,2 mm. Hylse på ledningsender. H05SST-F.		







	Tekstilledning 2x0,75 mm² T105	
	403A0012 guld	100 m.
	PVC T105, PVC T105. Flad 2,9x5,4 ± 0,2 mm. H05V-K. To dobbeltisolerede enkeltledere, side by side, med guld tekstil.	

	Ledningssæt 2x0,75 mm² T180		
	405B3007	3 m. hvid	50 stk.
	405B5007	5 m. hvid	50 stk.
	Silikone T180, Silikone T180. Rund Ø6,8 ± 0,2 mm. Hylse på ledningsender. H05SST-F.		

	Ledningssæt m/EU- stik og tekstil	
	422A4007 4 m. hvid	100 stk.
	422A4008 4 m. sort	100 stk.
	Flad ledning 2x0,75 mm ² . 2,5A, 250V. Hylse på ledningsender. H03VVH2-F.	

	Ledningssæt 2x0,75 mm² T180		
	405B3008	3 m. sort	50 stk.
	405B4008	4 m. sort	50 stk.
	Silikone T180, Silikone T180. Rund Ø6,8 ± 0,2 mm. Hylse på ledningsender. H05SST-F.		

Membrannipler

	<p>Membrannippel PG13,5</p> <p>440G0005 grå 1000 stk. 440G0105 grå 25 stk.</p> <p>Passer i pladetykkelse 1,5 mm. Fremstillet i plast til anvendelse i forbindelse med stænktæt materiel. Ø21-22 mm. Kabeldimensioner Ø8-Ø15 mm. PVC, CE.</p>		<p>Gummimembran</p> <p>930M0007 hvid 1000 stk.</p> <p>Ø21 mm. TPE.</p>
	<p>Membrannippel PG13,5 m/hul</p> <p>440G1005 grå Santoprene 1000 stk. 440G2005 grå PVC 1000 stk.</p> <p>Passer i pladetykkelse 1,5 mm. Fremstillet i plast til anvendelse i forbindelse med stænktæt materiel. Ø21-22 mm. Kabeldimensioner Ø8-Ø15 mm. CE.</p>		<p>Membrannippel</p> <p>440J0007 hvid 1000 stk.</p> <p>Ø22 mm. Pladehul Ø19,5 mm. EVA.</p>
	<p>Membrannippel</p> <p>440M0005 <u>PG9</u> grå 500 stk. For kabel Ø5-7 mm. Pladehul Ø16 mm., pladetykkelse 1-4 mm.</p> <p>440N0005 <u>PG11</u> grå 500 stk. For kabel Ø7-10 mm. Pladehul Ø19 mm., pladetykkelse 1-4 mm.</p> <p>440P0005 <u>PG16</u> grå 500 stk. For kabel Ø10-14 mm. Pladehul Ø23 mm., pladetykkelse 1-4 mm. EPDM.</p>		<p>Membrannippel PG13,5</p> <p>440H0007 hvid 1000 stk.</p> <p>Ø24 mm. Pladehul Ø20 mm. Pladetykkelse 1-2 mm. PVC.</p>
	<p>Membrannippel PG16</p> <p>440E0105 grå 25 stk.</p> <p>Fremstillet i plast til anvendelse i forbindelse med stænktæt materiel. Kabeldimensioner: Ø6-Ø15 mm. CE.</p>		



Muffer metal

	Muffe M8x1 Ø10
	431039 messing L=10 mm. 250 stk. 431239 messing L=12 mm. 250 stk.

	Indføringsmuffe
	030237 el-galv. 250 stk. Ø20x18 mm. M10x1 indvendig gevind. Jern.

	Muffe M10 Ø12
	120436 L= 4 mm. 1000 stk.
	120636 L= 6 mm. 1000 stk.
	121236 L=12 mm. 1000 stk.
	121436 L=14 mm. 1000 stk.
	121636 L=16 mm. 1000 stk. 036A0136 L=16 mm. 50 stk. Messing.

	Indføringsmuffe
	030236 messing 250 stk. Ø12 mm., L=20 mm. Med 2 sidefræsninger. M10x1 indvendig gevind.

	Muffe M13 Ø15
	132036 messing L=20 mm. 1000 stk.

	Stopring for Ø10 mm. rør
	254038 m/recess 250 stk. 250038 u/recess 250 stk. Messing.

	Muffe M10 Ø12
	121219 forniklet L=12 mm. 1000 stk. 122019 forniklet L=20 mm. 1000 stk.

	Stopring for Ø8 mm. rør
	254838 m/recess 250 stk. 354838 u/recess 250 stk. Messing.

	Topstykke
	171636 messing 250 stk. Ø18 mm., 15 mm. lang. M16x1 indvendig gevind. Tophul Ø10 mm.

Muffer plast

	Polykonmuffer natur	
	450A0106 Ø16x100	50 stk.
	450B0106 Ø25x90	50 stk.
	450C0106 Ø32x120	50 stk.
	450D0106 Ø16x80	50 stk.
	450E0106 Ø20x80	50 stk.
	Polyethylene.	

	Vinkelstykke Ø16 mm.	
	453I0106 hvid	50 stk.
	PVC.	

	T-stykke Ø16 mm.	
	454A0106 hvid	50 stk.
	PVC.	





Møtrikker

	Møtrik M10x1 002C3036 messing 1000 stk. 6-kt. NV 12x1,5 mm.
---	--

	Topmøtrik M4 687438 krom 1000 stk. 6-kt. NV 7x8 mm. Messing.
---	--

	Møtrik M10x1 231029 jern/el-galv. 1000 stk. 037A0118 jern/el-galv. 50 stk. 6-kt. NV 14x3 mm. 230918 jern/el-galv. 1000 stk. 6-kt. NV 12x3 mm.
---	---

	Møtrik M8x1 230818 jern el-galv. 1000 stk. 6-kt. NV 11x3 mm.
--	---

	Møtrik M10x1 231036 messing. 1000 stk. 037C0136 messing. 50 stk. 6-kt. NV 14x3 mm.
---	--

	Møtrik M13x1 231329 jern/el-galv. 1000 stk. 037B0118 jern/el-galv. 50 stk. 6-kt. NV 17x3 mm. 231318 jern/el-galv. 1000 stk. 6-kt. NV 17x5 mm.
--	---

	Møtrik M10x1 037B0029 jern el-galv. 1000 stk. 6-kt. NV 13x6 mm. 037C0029 jern el-galv. 1000 stk. 6-kt. NV 14x6 mm.
---	---

	Møtrik M13x1 231336 Messing. 1000 stk. 6-kt. NV 17x3 mm.
--	---

	Plastmøtrik M10x1 ARD002193 hvid 1000 stk. ARD002194 sort 1000 stk. 6-kt. NV 14x3 mm. Termoplast.
---	--

	Møtrik M16x1 231618 jern el-galv. 1000 stk. 6-kt. NV 22x3 mm.
--	--

	Plastmøtrik M10x1 038A0007 hvid 1000 stk. 038A0008 sort 1000 stk. 6-kt. NV 14x6 mm. Termoplast.
---	--

	Kontramøtrik grå 445F0105 PG11 NV22 100 stk. 445G0105 PG9 NV19 100 stk. Polycarbonate.
--	--





Møtrikker facon

	Faconmøtrik M10 101526 messing 1000 stk. 101519 forniklet 1000 stk. Ø15x3 mm.
---	---

	Rouletmøtrik M10x1 101325 messing 1000 stk. 047A0136 messing 50 stk. Ø13x2,5 mm.
--	--

	Faconmøtrik M10 101726 messing. 1000 stk. Ø17x3 mm.
---	--

	Rouletmøtrik M13 131725 messing 500 stk. Ø17x3 mm.
--	---











	Halvmøtrik M10 101536 messing 1000 stk. Ø15x3 mm.
---	--

	Faconmøtrik M13 132126 messing 1000 stk. Ø21x3 mm.
---	---

	Faconmøtrik M13 131726 messing 1000 stk. Ø17x3 mm.
---	---

	Faconmøtrik M16 162226 messing 1000 stk. Ø22x3 mm.
---	---

Nipler: Krave-, lodde- og ringnipler

	<p>Kravenippel M10 rundt hoved 150037 500 stk. Ø12x9 mm. Gevind 7 mm. Messing.</p>		<p>Ringnippel M10 åben 011030 messing 100 stk. L22xØ18x3 mm. 301030 messing 100 stk. L26xØ23x4 mm.</p>
	<p>Kravenippel M10, 6-kt 212037 L: 10 mm, G: 8mm 500 stk. 212237 L: 12 mm, G: 10mm 500 stk. 021A0136 L: 12 mm, G: 10mm 50 stk. 212537 L: 15 mm, G: 13mm 500 stk. NV12. Messing.</p>		<p>Ringnippel M10x1 041030 åben 100 stk. 041031 lukket 100 stk. Ø28/Ø33x4 mm. Messing.</p>
	<p>Kravenippel M10 fræst 6-kt 212637 L = 10 mm, G = 8 mm 500 stk. NV12. Messing.</p>		<p>Ringnippel M10x1 031030 åben 100 stk. 031031 lukket 100 stk. Ø40/Ø46x5 mm. Messing.</p>
	<p>Kravenippel M10 fræst 6-kt ARD002146 sort 1000 stk. NV12. Længde = 18 mm. Gevind = 15 mm. Termoplast.</p>		<p>Ringnippel M10 åben m/tænder 273030 100 stk. 33x42 mm. Messing.</p>
	<p>Kravenippel M8, 6-kt 208237 L = 12 mm, G = 10 mm 500 stk. 208037 L = 11 mm, G = 9 mm 500 stk. NV10. Messing.</p>		
	<p>Loddenippel 159337 250 stk. Længde = 13 mm. Gevind = 9 mm. Messing.</p>		

Nipler: Reduktionsnipler

	Reduktionsnippel M10u/M8i	
	421039 L = 6 mm.	100 stk.
	421239 L = 12 mm.	100 stk.
	Messing.	

	Overgangsnippel M10u/M10i	100 stk.
	325D0100	
	Messing.	

	Reduktionsnippel M13u/M10i	100 stk.
	407039	
	Messing.	

	Pladenippel M10	50 stk.
	066A0136	
	Ø25x10 mm.	
	Messing.	

	Reduktionsnippel M13u/M10i	
	422139 L = 7 mm.	100 stk.
	422039 L = 10 mm.	100 stk.
	Messing.	









	Reduktionsnippel M13i/M10u	
	168039	100 stk.
	042A0136	25 stk.
	M13 indv./M10 udv. x 8 mm.	
	Ø15x18 mm. Messing.	

	Reduktionsnippel M16i/M10u	
	404039	100 stk.
	Ø18x15 mm.	
	Messing.	

	Reduktionsnippel M13i/M10i	
	425039	100 stk.
	Ø15x12 mm.	
	Messing.	

	Reduktionsnippel M16i/M10i	
	426039	100 stk.
	Ø18x15 mm.	
	Messing.	

Ophæng

	<p>Pendelophæng kl. 2 432E0008 sort 250 stk.</p> <p>Inklusiv aflastningsbøjle med selvskærende skruer. Med plads til 2-polet klemrække (TBI 135/2). Med ledningsstyr, CE. Polycarbonat.</p>		<p>Loftkrog Ø18,5x50 mm. 431A0029 el-galv. 500 stk.</p> <p>Ø3 mm. Bæreevne: 5 kg. Jern.</p>
	<p>Pendelophæng kl. 2 20004 natur 1000 stk.</p> <p>Passer for 2-polet klemrække TBI 135/2. 40x30 mm. Polypropylen.</p>		<p>S-krog 431C0007 500 stk.</p> <p>Ø2 mm. Øjer indv.: Ø5,8 mm., Ø10,2 mm. Længde 25,4 mm. Jern forniklet.</p>
	<p>Ophængssæt for pendel 916A0006 500 stk. 916A0106 25 stk.</p> <p>Bestående af: 431A0029 loftkrog. 20004 pendelophæng kl. 2. 135/2 klemrække 2-polet 4,0 mm².</p>		
	<p>Pendelophæng f/krog 432B0007 hvid 500 stk. 432B0107 hvid 25 stk. 432B0008 sort 500 stk. 432B0108 sort 25 stk. Polypropylen.</p>		
	<p>Ophængskrog 931C0007 hvid 1000 stk.</p> <p>38x17,5x3 mm. Hul Ø8 mm. Plus 2xØ6 mm. huller. Polyacetal.</p>		
	<p>Pendelophæng 3-huls 800306 natur 1000 stk.</p> <p>32x12,5 mm. 3 stk. Ø7 mm. huller. Polypropylen.</p>		

Ophæng

	Pendelophæng m/skrue	
	432F0007 hvid	500 stk.
	432F0008 sort	500 stk.
Passer for 2x0,75 mm ² PKL. Polyamid.		

	Svanehals	
	432V0107 hvid	1/25 stk.
	432V0108 sort	1/25 stk.
	432V0122 messing	1/25 stk.
432V0137 krom		1/25 stk.
Passer for 2x0,75 mm ² PKL. Træskruer: 5,5x30 mm. el-galv.		

	Pendelophæng med skrue	
	432F0107 hvid	25 stk.
	432F0108 sort	25 stk.
Pakket i salgskarton. Passer for 2x0,75 mm ² PKL. Polyamid.		

	Svanehals	
	432X0107 hvid	1/25 stk.
	432X0108 sort	1/25 stk.
Passer for 2x0,75 mm ² PKL. Træskruer: 4x30 mm. el-galv.		

	Ledningsforkorter	
	432P0006 transp.	10 stk.
	432P0107 hvid	10 stk.
	432P0007 hvid	100 stk.
	432P0108 sort	10 stk.
Passer for 2x0,75 mm ² PKL. Polystyrol.		

	Loftbeslag	
	432R0107 30 mm. skrue	1/25 sæt.
	432S0107 50 mm. skrue	1/25 sæt.
	M4 øjeskrue el-galv. Træskruer UH M/M4 el-galv.	

	Ledningsholder for loft & væg	
	432C0107 hvid	10 stk.
	432C0108 sort	10 stk.
Ø23 mm, højde 18mm. Skrue og rawplug medfølger. Termoplast.		
		

	Armaturophæng	
	432U0118 el-galv.	1/25 sæt.
	432U0124 rustfri	1/25 sæt.
1 sæt: 2 øjeskruer og 4 møtrikker. Øjeskrue M4x20 mm. Aluminiumsmøtrikker.		
		

Ophæng

	Rollyhejs 2x0,75 mm²		
	43211407	hvid 1,4 m tekstil	1 stk.
	43211408	sort 1,4 m tekstil	1 stk.
	43211807	hvid 1,8 m tekstil	1 stk.
	43211808	sort 1,8 m tekstil	1 stk.
	432J1807	hvid 1,8 m PVC	1 stk.
Bæreevne max. 4 kg. 90 grader.			

	Ringkæde 15x10x2 mm.	
	163018 formessinget	10 m.
	163021 bruneret	10 m.
	Jern.	

	Baldakin til Rollyhejs	
	432G0107	hvid 1 stk.
	432G0108	sort 1 stk.
	Ø90 mm., højde 110 mm.	

	Ringkæde 40x16x2,8 mm.	
	163317 jern rå	10 m.
	163318 formessinget	10 m.
	163321 bruneret	10 m.
Jern.		

	Spiralhejs 2x0,75 mm²	
	432H1807	hvid 1,8 m 1 stk.
	432H1808	sort 1,8 m 1 stk.
	Bæreevne max. 5 kg. 70 grader. Baldakin Ø90 mm., højde 110 mm.	

	Lampetophæng, nøglehul	
	662017 el-galv.	500 stk.
	43x16 med hul Ø10,5 mm.	
	Jern.	

	Spiralhejs 2x0,75 mm²	
	432H1207	hvid 1,2 m 1 stk.
	Med E27 fatning, skjuler og baldakin.	
	Bæreevne max. 5 kg. 70 grader. Baldakin Ø90 mm., højde 110 mm.	

	Ophæng t/halogen M10	
	20006 messing	1000 stk.
	20019 forniklet	1000 stk.
	Ø12x12 mm. Hul Ø4,5 mm.	

	Kroneophæng	
	70017 el-galv.	100 stk.
	30x30 mm. M10x1.	
	Jern, med jord- og låseskrue.	

	Skomagerophæng	
	700334 formessinget	50 stk.
	Ø60i. mm.	
	Jern. Med 3 stk. fingerskrue.	

	Kroneophæng med bøjle	
	70029 el-galv.	100 stk.
	23x30 mm. M13x1.	
	Jern, med jord- og låseskrue.	





Rørnipler

	Rørnipler M10x1 rund		
	010018	10 mm.	3000 stk.
	012018	12 mm.	2000 stk.
	015018	15 mm.	2000 stk.
	017018	17 mm.	2000 stk.
	020018	20 mm.	1500 stk.
	025018	25 mm.	1200 stk.
	030018	30 mm.	1000 stk.
	035018	35 mm.	1000 stk.
	040018	40 mm.	1000 stk.
	045018	45 mm.	500 stk.
	050018	50 mm.	500 stk.
	055018	55 mm.	500 stk.
	060018	60 mm.	500 stk.
	065018	65 mm.	500 stk.
	070018	70 mm.	300 stk.
	075018	75 mm.	300 stk.
	080018	80 mm.	300 stk.
	085018	85 mm.	250 stk.
	090018	90 mm.	250 stk.
	095018	95 mm.	250 stk.
100018	100 mm.	250 stk.	
110018	110 mm.	200 stk.	
120018	120 mm.	150 stk.	
130018	130 mm.	150 stk.	
140018	140 mm.	150 stk.	
145018	145 mm.	150 stk.	
150018	150 mm.	150 stk.	
160018	160 mm.	150 stk.	
170018	170 mm.	150 stk.	
190018	190 mm.	150 stk.	
200018	200 mm.	150 stk.	
Jern, el-galv. Ø6,5i mm.			

	Rørnipler M10x1 rund		
	044A1010	10 mm.	50 stk.
	044A1012	12 mm.	50 stk.
	044A1015	15 mm.	50 stk.
	044A1017	17 mm.	50 stk.
	044A1020	20 mm.	50 stk.
	044A1025	25 mm.	50 stk.
	044A1030	30 mm.	50 stk.
	044A1040	40 mm.	50 stk.
	044A1050	50 mm.	50 stk.
	Jern, el-galv. Ø6,5i mm.		

	Rørnipler M10x1 fræst		
	010218	10 mm.	2000 stk.
	015218	15 mm.	2000 stk.
	017218	17 mm.	2000 stk.
	020218	20 mm.	2000 stk.
	025218	25 mm.	1000 stk.
	030218	30 mm.	1000 stk.
	035218	35 mm.	1000 stk.
	040218	40 mm.	1000 stk.
	045218	45 mm.	500 stk.
	050218	50 mm.	500 stk.
	055218	55 mm.	500 stk.
	060218	60 mm.	500 stk.
	065218	65 mm.	500 stk.
	075218	75 mm.	300 stk.
	080218	80 mm.	300 stk.
	085218	85 mm.	250 stk.
090218	90 mm.	250 stk.	
100218	100 mm.	250 stk.	
Jern, el-galv. Ø6,5i mm.			

	Gevindrør M10x1 rund		
	000017	M10 rå	1 stk.
	000018	M10 el-galv.	1 stk.
Jern, el-galv. Ø6,5i mm			
Længde = 1000 mm.			

	Gevindrør M10x1 rund messing		
	044B1500	M10	10 stk.
	Messing.		
Længde = 500 mm.			

	Rørnipler M10x1 rund messing		
	012036	12 mm.	1000 stk.
	015036	15 mm.	1000 stk.
	017036	17 mm.	1000 stk.
	020036	20 mm.	1000 stk.
	Messing. Ø7,6i mm.		
	036B1030	30 mm.	50 stk.
Messing. Ø6,5i mm.			



Rørnipler

	Rørnipler M8 rund messing		
	012818	12 mm.	2500 stk.
	015818	15 mm.	2500 stk.
	020818	20 mm.	2500 stk.
Messing. Ø4,9i mm.			

	Rørnipler M13x1 rund		
	015318	15 mm.	1000 stk.
	025318	25 mm.	500 stk.
	030318	30 mm.	500 stk.
	035318	35 mm.	500 stk.
	055318	55 mm.	250 stk.
	090318	90 mm.	150 stk.
Jern, el-galv. Ø9,5i mm.			

	Gevindrør M13x1 rund		
	000318	M13 el-galv.	1 stk.
	Jern, el-galv. Længde = 1000 mm.		

	Gevindrør M13x1 rund messing		
	501336	M13	10 stk.
	Messing. Længde = 500 mm.		

Skærme & Skærmstativer

	Skærm Ø88x86 mm.	
	129200 blå	500 stk.
	129207 hvid	500 stk.
	Tophul Ø29 mm. Polycarbonat.	

	Skærm Ø148x73 mm.	
	407500 blå	500 stk.
	407507 hvid	500 stk.
	Tophul Ø29 mm. Polycarbonat.	

	Skærm riflet Ø94x87 mm.	
	129300 blå	500 stk.
	129306 klar	500 stk.
	129307 hvid	500 stk.
Tophul Ø29 mm. Polycarbonat.		

	Skærm Ø172x103 mm.	
	407600 blå	500 stk.
	407607 hvid	500 stk.
	Tophul Ø29 mm. Polycarbonat.	

	Skærm Ø139x120 mm.	
	129400 blå	500 stk.
	129407 hvid	500 stk.
	129410 champagne	500 stk.
Tophul Ø10,5 mm. Polycarbonat.		

	Skærm halvkugle Ø145 mm.	
	407707 hvid	500 stk.
	Tophul Ø29 mm. Polycarbonat.	

	Skærm Ø139x120 mm.	
	129500 blå	500 stk.
	129507 hvid	500 stk.
	129510 champagne	500 stk.
Tophul Ø29,5 mm. Polycarbonat.		

	Skærm Ø240x104 mm.	
	407800 blå	500 stk.
	407807 hvid	500 stk.
	Tophul Ø41 mm. Polycarbonat.	

	Skærm Ø80x110 mm.	
	129607 hvid	500 stk.
	Tophul Ø10,5 mm. Polycarbonat.	

	Skærmstativ hvid/klar for E27	
	401A0007 T/Ø34 mm.	1 stk.
	401B0007 T/Ø40 mm.	1 stk.
	Jern. PS. Polyamid. Forskydelig 140-210 mm. Skærmhul Ø90 mm.	

	Skærm Ø78x59 mm.	
	129707 hvid	500 stk.
	Tophul Ø29 mm. Polycarbonat.	

	Skærm Ø112x36 mm.	
	407407 hvid	500 stk.
	Tophul Ø10 mm. Polycarbonat.	



Skiver

	Mellemlægsskive 1006 transp. 1000 stk. Ø22/Ø11x2,5 mm. Polyethylen.
---	---

	Tandskive indv. fortanding 241329 el-galv. blank 1000 stk. 038A0129 el-galv. blank 50 stk. Ø14/Ø10,5x0,5 mm. Stål.
--	---

	Underlagsskive 1107 hvid 1000 stk. 1108 sort 1000 stk. Ø22/Ø11x2,5 mm. ABS.
---	--

	Tandskive indv. fortanding 241129 el-galv. 1000 stk. Ø18/Ø10,5x0,9 mm. Stål.
--	--

	Underlagsskive buet 243219 forniklet 1000 stk. Ø22/Ø10,5x1 mm. Jern.
---	--

	Tandskive indv. fortanding 241429 el-galv. blank 1000 stk. Ø20/Ø13,2x1 mm. Stål.
--	--

	Skive 1828A216456 natur 1000 stk. Ø30/Ø10,5x1,5 mm. POM.
---	--

	Tandskive udv. fortanding 241223 el-galv. 1000 stk. Ø18/Ø10,5x0,8 mm. Stål.
--	---

Stikpropper

	Hanstik	
	101A0106 transp.	10 stk.
	101A0107 hvid	10 stk.
	101A0108 sort	10 stk.
	16A, 250V. Termoplast.	

	Apparastik han	25 stk.
	101Q0108 sort	
	3-polet, 10A, 250V, 70°C. C14.	
	Termoplast.	

	Schuko stikprop	
	101C0107 hvid	50 stk.
	101C0108 sort	50 stk.
	16A, 250V. Termohærdende.	

	Apparastik hun	25 stk.
	101R0108 sort	
	3-polet, 10A, 250V, 120°C. C15.	
	Termoplast.	

	Schuko hunstik	
	103A0007 hvid	50 stk.
	16A, 250V. Termoplast.	

	Stikprop for rund ledning	
	101D0107 hvid	100 stk.
	101D0108 sort	100 stk.
	16A, 250V. Termoplast.	

	Schuko hanstik vinkel	
	101E0107 hvid	50 stk.
	16A, 250V. Termoplast.	

	Stikprop engelsk	
	101XH007 hvid	20 stk.
	101XH008 sort	20 stk.
	3-pol, 3 amperes sikring.	

Stikpropper - UK adaptor

	<p>UK - adaptor 101XA007 hvid 250 stk. 101XA008 sort 250 stk.</p> <p>250V, 2,5A. 3A sikring. Termoplast.</p>
---	---

	<p>UK - adaptor 101XB007 hvid 250 stk. 101XB008 sort 250 stk.</p> <p>250V, 8A. 3A sikring. Termoplast.</p>
---	---

	<p>UK - adaptor 101XC007 hvid 250 stk. 101XC008 sort 250 stk.</p> <p>250V, 13A. 3A sikring. Termoplast.</p>
--	--

	<p>UK - adaptor 101XD007 hvid 250 stk. 101XD008 sort 250 stk.</p> <p>250V, 13A. 3A sikring. Termoplast.</p>
---	--

	<p>UK - adaptor 101XE007 hvid 250 stk. 101XE008 sort 250 stk.</p> <p>250V, 8A. 3A sikring. Termoplast.</p>
---	---

Tyller, blindpropper

	Blindprop t/Ø6 mm. hul	
	142007 hvid	1000 stk.
	142008 sort	1000 stk.
	Ø8x5 mm. for Ø6 mm. hul. Polyethylen.	

	Tylle t/Ø9 mm. hul	
	60307 hvid	1000 stk.
	Ø13x7 mm. Polyethylen.	

	Tylle t/Ø7 mm. hul	
	60106 natur	1000 stk.
	60108 sort	1000 stk.
	Ø7/Ø6x11 mm. Ø8,5 mm. krave der tillader møtrik, at blive monteret efter at isolertyllen er isat. Polyethylen.	

	Tylle t/Ø9,2 mm. rør	
	1701A160310 hvid	1000 stk.
	1701A160320 sort	1000 stk.
	1701A160300 transp.	1000 stk.
Ø11,8x11,4 mm. for Ø9,2 mm. hul. Polyethylen.		

	Tylle t/Ø7 mm. rør	
	1705A96507 natur	1000 stk.
	Ø12x9,4 mm. for Ø7 mm. hul.	

	Tylle t/Ø10 mm. hul	
	60606 natur	1000 stk.
	60607 hvid	1000 stk.
	60608 sort	1000 stk.
Polyethylen.		

	Tylle t/Ø8 mm. hul	
	60206 natur	1000 stk.
	60208 sort	1000 stk.
	Ø8/Ø6x11 mm. Ø10 mm. krave. Polyethylen.	

	Tylle t/Ø10 mm. hul	
	60506 natur	1000 stk.
	067A0106 natur	50 stk.
	60507 hvid	1000 stk.
	067A0107 hvid	50 stk.
	60508 sort	1000 stk.
	067A0108 sort	50 stk.
8 mm. lang. Polyethylen.		

	Tylle t/Ø8 mm. hul	
	1701A160100 natur	1000 stk.
	1701A160110 hvid	1000 stk.
	1701A160120 sort	1000 stk.
Ø10x8 mm. Polyethylen.		

	Tylle til gevind M10	
	068C0008 M10x 7 sort	1000 stk.
	ARD012017 M10x10 hvid	1000 stk.
	ARD009457 M10x10 sort	1000 stk.
	068E0007 M10x15 hvid	1000 stk.
	068G0007 M10x20 hvid	1000 stk.
	068A0107 M10x6,5 hvid	50 stk.
	068A0108 M10x6,5 sort	50 stk.
Termoplast.		

	Tylle t/Ø9 mm. hul	
	60406 natur	1000 stk.
	60407 hvid	1000 stk.
	60408 sort	1000 stk.
Ø13x14 mm. Polyethylen.		

	Blindprop t/Ø10 mm. hul	
	143007 hvid	1000 stk.
	143008 sort	1000 stk.
	Ø13x9 mm. for Ø10 mm. hul. Polyethylen.	

Tyller, blindpropper

	Tylle t/Ø10,2 mm. rør	
	1701A160400 natur	1000 stk.
	1701A160420 sort	1000 stk.
	Ø12,8x11,9 mm. for 10,2 mm. hul. Polyethylen.	

	Tylle t/Ø15 mm. hul	
	1705A81807 hvid	1000 stk.
	Ø17,5x13,2 mm. for Ø15 mm. hul. Polyethylen.	

	Tylle t/Ø10,2 mm. hul	
	1705A81207 hvid	1000 stk.
	1705A81208 sort	1000 stk.
	Ø12x8,1 mm. for Ø10,2 mm hul. Polypropylen.	

	Tylle t/Ø18,6 mm. hul	
	1705A85007 hvid	1000 stk.
	Ø20,2x8,3 mm. for Ø18,6 mm hul. Polyethylen.	

	Tylle t/Ø11 mm. hul	
	1705A81508 sort	1000 stk.
	1705A81507 hvid	1000 stk.
	Ø12,8x9,1 mm. for Ø11 mm. hul. Polyethylen.	

	Tylle t/Ø22,5 mm. hul	
	1705A85607 hvid	1000 stk.
	Ø25x8,3 mm. for Ø22,5 mm hul. Polyethylen.	

	Tylle t/Ø11 mm. hul	
	60706 natur	1000 stk.
	60707 hvid	1000 stk.
	60708 sort	1000 stk.
	Ø13,8x7,8 mm. for Ø11 mm. hul. Polyethylen.	







	E40 isolerindsats	
	1701A163200 natur	1000 stk.
	12 mm. Hul Ø9 mm. For Ø10 mm. hul. Polyethylen.	

	Tylle til gevind M13	
	068B0107 M13x7,5 hvid	50 stk.
	Termoplast.	











	E40 isolerindsats	
	E271206 hvid, 12 mm.	1000 stk.
	E271506 hvid, 15 mm.	1000 stk.
	Hul Ø9 mm. For Ø10 mm. hul. Polyamid.	

	Tylle t/Ø13 mm. hul	
	60906 natur	1000 stk.
	067B0106 natur	50 stk.
	60907 hvid	1000 stk.
	Polyethylen.	

Tyller, blindpropper

	<p>Blindprop PG16 443D0019 250 stk.</p> <p>Messing forniklet. Hoved diameter 24 mm. Højde 9,5 mm.</p>		<p>Pakdåse PG13,5 440K0005 grå 250 stk.</p> <p>Polystyrol.</p>
	<p>Blindprop PG21 443C0019 250 stk.</p> <p>Messing forniklet. Hoved diameter 30 mm. Højde 11 mm.</p>		<p>Pakdåse PG16 440B0105 grå 25 stk.</p> <p>Fremstillet i polyamid, med pakning af nitrilgummi. Forsynet med ekstra indlæg der muliggør tilpasning af alle kabeldimensioner fra: Ø8-Ø13 mm. CE.</p>
	<p>Blindprop PG13,5 443A0005 grå 250 stk.</p> <p>Polystyrol.</p>		<p>Pakdåse m/afkastning grå 446D0105 PG16 25 stk.</p> <p>Fremstillet i polyamid med pakning af nitrilgummi. Aflaster og pakker alle kabler fra Ø6-Ø15 mm. CE.</p>
	<p>Blindprop PG16 443B0005 grå 250 stk.</p> <p>Polystyrol.</p>		

USA – materiel 1

	<p>Gennemgangsafbryder 1 pol.</p> <p>1266B0007 hvid 100 stk. 1266B0008 sort 100 stk.</p> <p>2A, 250V. Passer for 2x0,75 flad og rund ledning.</p>		<p>Fodkontakt f/SPT-2</p> <p>002F0007 hvid 200 stk.</p> <p>125V, 3A. UL, CSA.</p>
	<p>USA-Stikprop</p> <p>415B0007 hvid 100 stk.</p> <p>10A, 125V. For SPT-2 kabel.</p>		<p>GU10 fatning f/påskrugning</p> <p>1857A0007 hvid 100 stk.</p> <p>Fastgøres med M3 skruer. Ledninger 25 cm. 2A, 250V, T250, UL. Steatite.</p>
	<p>Ledning SPT-2</p> <p>410A0007 hvid 200 m. 410A0008 sort 200 m.</p> <p>PVC T105. 300V, 2x18AWG. Flad 3,6x7,2 ± 0,2 mm. UL.</p>		<p>USA baldakin komplet</p> <p>412D0007 hvid 100 stk.</p>
	<p>Ledning SVT-2</p> <p>410B0007 hvid 305 m. 410B3007 hvid 3 m. 410B0008 sort 305 m.</p> <p>PVC T105. 300V, 2x18AWG. Rund Ø5,8 ± 0,2 mm. UL.</p>		<p>Baldakin hvid Ø125x87 mm.</p> <p>ARD013160 250 stk. M6x807. M6 skrue hvid 250 stk.</p> <p>Ledningshul Ø7 mm., UL. Termoplast.</p>
	<p>Ledning 2x18AWG transp.</p> <p>410G0006 300 m.</p> <p>FEP T200, PVC T105. 300V, 2x18AWG. Rund Ø5,0 ± 0,2 mm. UL.</p>		
	<p>Ledning SVT-3</p> <p>410K0007 hvid 200 m. 410K0008 sort 200 m.</p> <p>PVC T105. 300V, 3x18AWG. Rund Ø6,6 ± 0,2 mm. UL.</p>		

USA – materiel 2

	<p>E26-E27 bund M10 NIP ARD001247 hvid 500 stk. ARD001246 sort 500 stk. Ø37,5x16,5 mm. T150, 250V, UL. Med M10 nippel i metal. Termohærdende.</p>		<p>E26-E27 klik bund M10 NIP ARD028236 sort 500 stk. Ø38x17 mm. T150, 250V, UL. Med M10 nippel i metal. Termoplast.</p>
	<p>E26 Indlæg ARD020643 500 stk. 660W, 250V, T150, UL. Termohærdende.</p>		<p>E26 klik fatning glat ARD023998 hvid 500 stk. ARD023999 sort 500 stk. Ø38x45 mm. 660W, 250V, T150, UL. Termoplast.</p>
	<p>E26-E27 bund M10 f/vip-afbryder ARD011125 sort 500 stk. Ø37,5x40,5 mm. T190, 4A, 250V, UL. Termohærdende.</p>		<p>E26 klik fatning ½ gevind ARD024074 hvid 500 stk. ARD024075 sort 500 stk. Ø40/Ø45x43,5 mm. 660W, 250V, T150, UL. Termoplast.</p>
	<p>E26 indlæg m/vip-afbryder ARD029187 sort 500 stk. 660W, 250V, T150, UL. Med skrueklammer.</p>		<p>E12-E14 bund M10 NIP ARD000638 sort 1000 stk. Med M10 Nippel i metal. Ø28x15 mm. T150, 75W, 125V, UL.</p>
	<p>E26 kappe glat ARD020645 hvid 500 stk. ARD020646 sort 500 stk. Ø39x35 mm. 660W, 250V, T150, UL. Termohærdende.</p>		<p>E12 indlæg ARD020526 1000 stk. T150, 75W, 125V, UL.</p>
	<p>E26 kappe ½ gevind ARD025289 hvid 500 stk. ARD025176 sort 500 stk. Ø46/Ø40x35 mm. 660W, 250V, T150, UL. Termohærdende.</p>		<p>E12 kappe glat ARD020528 sort 1000 stk. T150, 75W, 125V, UL.</p>
	<p>E26-E27 omløbsring Ø47 mm. ARD011094 hvid 500 stk. ARD011095 sort 500 stk. Ø47x9 mm. Termoplast.</p>		<p>E26-E27 omløbsring Ø57 mm. ARD012607 hvid 500 stk. ARD011091 sort 500 stk. Ø57X12 mm. Termoplast.</p>

Wiremateriale 1

	Wirelås M4 434A0019 forniklet 500 stk. Ø10x37 mm. Messing. Anbefalet wire Ø1,2 mm. Bæreevne 10 kg.
---	--

	Øjeskrue åben M4 434A1019 forniklet 500 stk. Ø16/Ø10 mm., M4x7 mm. Stål.
--	--

	Wirelås M8 434B0019 forniklet 500 stk. Ø9x17,5 mm. Messing. Anbefalet wire Ø1,2 mm. Bæreevne 10 kg.
---	---

--	--

	Wirelås M10 m/spærre 434C0019 forniklet 500 stk. Ø12x27 mm. Messing. Anbefalet wire Ø1,2 mm. Bæreevne 10 kg.
---	--

	Loftophæng m/slids M10x1i 434L0019 forniklet 500 stk. Hoved Ø16 mm, krop Ø12x26 mm. Messing. Går samme med 434C0019 wirelås. Går samme med 434M0019 bøsning.
--	--

	Wirelås M10 434D0019 forniklet 500 stk. Ø10x25 mm. Messing. Anbefalet wire Ø1,2 mm. Bæreevne 10 kg.
---	---

	Bøsning m/kærv f/wire m/kugle 434M0019 forniklet 500 stk. Ø12x10 mm. Messing. Kan anvendes samme med: 434L0019 loftophæng.
--	--

	Wirelås triangel 434K0019 forniklet 500 stk. Ø9x35 mm. Messing. Anbefalet wire Ø1,2 mm. Bæreevne 10 kg.
---	---

	Stålwire 108 mm m/øjer 874J0019 el-galv. 108 mm. 500 stk. Wire Ø1,2. Øjediameter Ø5,1 mm. Stål. Kan anvendes samme med: 434K0019 wirelås triangel.
--	--

	Bøsning top m/M5 f/wire m/kugle 434N0019 forniklet 500 stk. Ø15x8,5 mm. Messing. Anvendes samme med 434P0019 og wire med kugle.
---	---

	Bøsning bund f/wire m/kugle 434P0019 forniklet 500 stk. Ø15x13,5 mm. Messing. Anvendes samme med 434N0019 og wire med kugle.
--	--

	Wireophæng M10 874H0019 forniklet 100 stk. 874H0032 aluminium 100 stk. 874H0036 formessinget 100 stk. Ø25x40 mm. Støbt aluminium.
---	---

	Wirenippel 432Y3019 forniklet 500 stk. Ø12x9 mm. Messing. Bevirker at emnet kan skydes fra side til side på wire eller bøjle.
--	---

Wiremateriale 2

	Wire Ø1,2 mm. 874F2018 el-galv. 2 m. 100 stk. Stål. Bæreevne i forbindelse med wirelås = 10 kg.
---	--

	Ledningsholder for wire Ø1,2 mm. 70506 natur 1000 stk. For Ø1,2 mm wire. For ledning med diameter Ø5,3-6,4mm. Termoplast.
--	--

	Wire Ø1,2 mm. m/kugle 874G2018 el-galv. 2 m. 100 stk. 874G3018 el-galv. 3 m. 100 stk. 874G4018 el-galv. 4 m. 100 stk. 874G5018 el-galv. 5 m. 100 stk. 874G6018 el-galv. 6 m. 100 stk. Stål. Bæreevne i forbindelse med wirelås = 10 kg.
---	--

	Wire Ø1,2 mm. på spole 874F0118 el-galv 100 m. Stål. Bæreevne i forbindelse med wirelås = 10 kg.
--	---

	Wireklemme f/Ø1,5 mm. 874E0132 aluminium 500 stk.
---	---

	Wirelås med skrue 972H0036 500 stk. Messing.
---	---

	Muffe med skrue 972Q0019 fornicket 1000 stk. Messing. 6x14 mm, hul Ø3,4 mm.
--	---

Wiremateriale: Ophængningseksempler

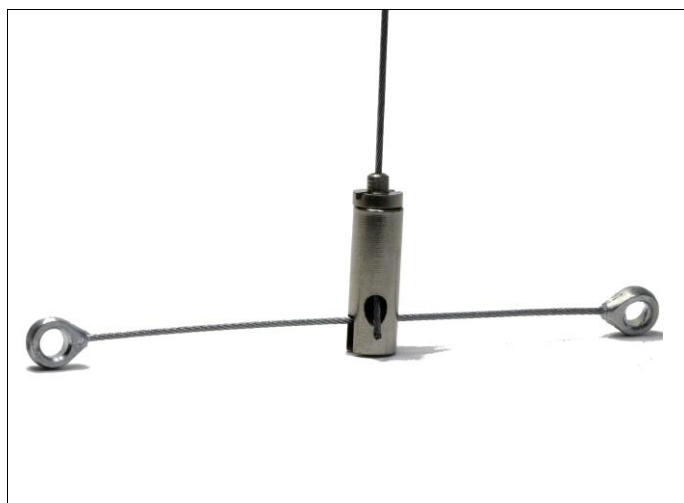

Bestående af:

Wirelås triangel forniklet	434K0019.
Stålwire 108 mm. m/øjer	874J0019 el-galv.
Wire Ø1,2 mm.	874F2018 el-galv.



Bestående af:

Wirelås M4 forniklet	434A0019.
Øjeskrue åben M4 forniklet	434A1019.
Wire Ø1,2 mm.	874F2018 el-galv.



Bestående af:

Loftophæng m/slids M10x1i forniklet	434L0019.
Wirelås M10 m/spærre forniklet	434C0019.
Wire Ø1,2 mm.	874F2018 el-galv.



Bestående af:

Loftophæng m/slids M10x1i forniklet	434L0019.
Bøsning m/kærv f/wire m/kugle forniklet	434M0019
Wire Ø1,2 mm. m/kugle	874G2018 el-galv.

Wiremateriale: Ophængssæt



432Y0119 - Ophængssæt "X-Tend" forniklet

Bestående af:

- 2 stk. 434C0019 Wirelås M10 m/spærre forniklet.
- 2 stk. 432Y2000 Ophængsbøjle X-Tend.
- 2 stk. 874F2018 Stålwire Ø1,2 mm. el-galv. 2 m.
- 2 stk. 874E0132 Wireklemme Ø1,5 mm. Alu.
- 2 stk. 432Y3019 Wirenippel forniklet X-Tend.
- 2 stk. 122019 Muffe Ø12x20 M10x1 forniklet.
- 2 stk. 170506 Aflastningsbro CL 16 natur.
- 2 stk. Plade skruer 2,9x19,0.



432Z0119 - Efix TBI ophæng

Bestående af:

- 2 stk. 434K0019 Wirelås triangel.
- 2 stk. 434L0019 Loftophæng m/slids M10x1i.
- 2 stk. 434M0019 Bøsning m/kærv f/wire m/kugle.
- 2 stk. 170506 Aflastningsbro CL 16 natur.
- 2 stk. Plade skruer 2,9x19,0.
- 2 stk. 874J0019 Stålwire Ø1,2 108 mm m/øjer.
- 2 stk. 874G2018 Stålwire Ø1,2 mm m/kugle 2 m.



433A0119 - Wireophængssæt komplet 2 m

Bestående af:

- 2 stk. 434N0019 Bøsning top m/M5 f/wire m/kugle.
- 2 stk. 434P0019 Bøsning bund f/wire m/kugle.
- 2 stk. 434G0019 Wirelås M13 m/bryst forniklet.
- 2 stk. 874G2018 Stålwire Ø1,2 mm m/kugle 2 m.
- 2 stk. Gipspladeskruer 3,9x30 ZP.



435A0019 - Ophængssæt m/wirelås M4 forniklet

Bestående af:

- 2 stk. 874F2018 Stålwire Ø1,2 mm. el-galv. 2 m.
- 2 stk. 434A0019 Wirelås M4 forniklet.
- 2 stk. 434A1019 Øjeskrue åben M4 forniklet.
- 2 stk. 432R2018 Træskrue UH 5,5x35 mm./M4 Fzb.
- 2 stk. 872B1201 Pinolskrue M4x12 mm.
- 2 stk. 432R2207 Skive Ø24xØ4,3 mm. hvid.
- 2 stk. 874E0132 Wireklemme Ø1,5 mm. Alu.
- 2 stk. 872C1201 Skrue M4x8 CHJS Fzb.



Agenturer

Arditi S.p.A.

Brembilla, Italien.
www.arditi.com

Carniaflex

Paluzza, Italien.
www.carniaflex.com

Mesu GmbH Metalltechnik

Sundern, Tyskland.
www.mesu.de

Otrac

Istanbul, Tyrkiet.
www.ortac.com.tr

PowerConnections

Harlow, England.
www.powerconnections.co.uk

Rovelli Antonio S.p.A.

Renate, Italien.
www.rovelliantonio.it

Tophat ApS

Holte, Danmark.